



AGRO POWER

Application guide



Edition 1/2012

Hightechmaschinen erfordern Hightechantriebstechnik

Die Firma Optibelt stellt – basierend auf mittlerweile weit über hundert Jahren Erfahrung in der Kautschukverarbeitung– seit 1948 Antriebs-riemen in den Unterschiedlichsten Varianten her. Ständige Investitionen in Materialforschung und Produktionstechnik sowie wachsende Kenntnisse über die mit den verschiedenen Einsatzfeldern verbundenen Randbedingungen haben dazu geführt, dass durch die Weiterentwicklung des Riemens zum Hightechantriebselement die Leistungsgrenzen der Maschinen immer weiter verschoben werden konnten.

OPTIBELT AGRO POWER Qualitätsriemen aus dem Hause Optibelt

Größer, schneller, weiter – außergewöhnliche Spitzenleistungen faszinieren die Menschen in allen Bereichen der Technik. Immer wieder überschreiten Ingenieure, Wissenschaftler und Forscher die Grenzen des Machbaren.

Doch was gibt uns den Ansporn, etwas Einzigartiges zu entwickeln? Weshalb wollen wir stets ein Stück weiter sein als der Wettbewerb? Die Motivation liegt in der Leidenschaft und Präzision.

Markenprodukte von Optibelt sind für Sie ein aktiver Investitionsschutz. Gerade weil unsere Antriebsriemen in Ihrem Produkt unsichtbar bleiben, legen wir das hinein, was woanders oft fehlt: Verantwortung und Qualität.

Mit unseren Top-Produkten, der Optibelt AGRO POWER Serie, setzen wir weltweit Tag für Tag neue Zeichen und sorgen dafür, dass die beste Lösung für die jeweilige Anwendung zum Einsatz kommt. Überall auf der Welt.

Leidenschaft
trifft
Präzision



Wie wir uns antreiben

Größer, schneller, weiter – außergewöhnliche Spitzenleistungen faszinieren die Menschen in allen Bereichen der Technik. Von der Antike bis heute – immer wieder überschreiten Ingenieure, Wissenschaftler und Forscher die Grenzen des Machbaren.

Doch was gibt uns den Ansporn, etwas Einzigartiges zu entwickeln? Weshalb wollen wir stets ein Stück weiter sein als der Wettbewerb? Die Motivation liegt in der Leidenschaft. Sie hilft uns auf der Suche nach dem besten Ergebnis und lässt uns niemals aufgeben.

Auch Optibelt zeichnet sich durch diese Leidenschaft für Technik aus. Jeder Mitarbeiter tritt mit seinem Spezialwissen, seiner Begeisterungsfähigkeit, seinen Visionen und seinen Initiativen für technologischen Fortschritt auf höchstem Niveau ein. Darauf können Sie sich verlassen!

Keine Maschinen ohne Antriebstechnik. Wollte man sich die moderne Welt ohne Antriebstechnik vorstellen, bliebe nicht viel übrig, was funktioniert. Maschinen sind ohne sie undenkbar. Die Antriebstechnik sorgt dafür, dass die Primärenergie des Motors für diverse Arbeitsprozesse umgewandelt und nutzbar gemacht wird.

Dabei kommt es darauf an, dass die Motorleistung mithilfe der Funktions-elemente an den Prozess angepasst wird. Allen voran gehört der Riemen als zentrales und Wirksamstes Element dazu. Bei vergleichsweise geringen Kosten und niedrigem Wartungsbedarf überbrücken Riemen nahezu beliebige Wellen-abstände. Diese Aufgabe bewältigen sie ohne Schmierung oder Führungselemente. Damit ist die Antriebstechnik mit Riemen beispielsweise Rollenketten-antrieben oder Stirnradstufen weit überlegen. Die vielseitige Einsetzbarkeit, ihre Anpassungsfähigkeit und Wirtschaftlichkeit machen sie bis heute in allen Branchen zu einem wesentlichen Bestandteil der Maschinenteknik.

Wie wir unsere Unternehmenswerte pflegen

Optibelt genießt international ein hohes Ansehen und steht für exzellente Markenqualität – made in Germany.

Dieses Prädikat ist nicht zuletzt darauf zurückzuführen, dass wir als familiengeführtes Unternehmen bis heute an unsere Wurzeln in Höxter und damit an den Standort Deutschland glauben. Zugleich ist die Firmengeschichte von Optibelt mit bahnbrechenden technischen Entwicklungen verknüpft: von der Industrialisierung bis zur automatisierten Welt. Jedem dieser Meilensteine hat sich Optibelt vorausschauend und mit Pioniergeist gestellt.

Dieses Zusammenspiel von Tradition und Innovationsbereitschaft kennzeichnet die Kernwerte unseres Unternehmens. Seit inzwischen über 135 Jahren. Unsere Unternehmensphilosophie tragen wir auch als modernes Unternehmen weiter: in unseren internationalen Vertriebsgesellschaften sowie Produktions- und Dienstleistungsfirmen. Dabei spielen Aus- und Weiterbildung eine Schlüsselrolle für die konstante Qualität, die Sie von unseren Produkten erwarten dürfen. Ihr Vorteil: Wir gehen weit über den Wettbewerbsstandard hinaus und erfüllen Anforderungen wie Just-in-time-Produktion, On-Stock-Verfügbarkeit, Kundennähe, Betreuung und Flexibilität mit Leichtigkeit und Engagement. Denn Ihr Antrieb ist unser Ansporn!

Contents



BISO - Schrattecker	8-10
BIZON	11-12
CASE INTL. HARVESTER	12-31
CLAAS	32-218
DEUTZ-FAHR	219-270
DRONNINGBORG	271-308
FENDT	309-311
FORTSCHRITT	312-316
JOHN DEERE	317-425
KRONE	426-427
LAVERDA	428-444
MASSEY FERGUSON	445-505
NEW HOLLAND	506-586
ROSTSELMASH	587-597

Contents

BISO - SCHRATTENECKER	8-10				
BIZON					
TC 59	11				
Z 110 BS	11-12				
CASE INTL. HARVESTER					
80, 85, 95, 715, 782, 820	12				
915, 923, 933, 943	13				
953	14				
1400	15				
1420	16				
1460	16-17				
1480	17				
1620	18				
1640	19				
1644	20				
1660	21				
1666	22				
1680	22-23				
1688, 2144	24				
2166	25				
2188	26				
2365	26-27				
2366	27				
2388, 1440E	28				
1460E, 8-41, 8-51	29				
8-61-321, 8-71-431	30				
8-91-531	31				
CLAAS					
COLUMBUS	32				
COMMANDOR 114	33-34				
COMMANDOR 114 CS	34-35				
COMMANDOR 115	36-37				
COMMANDOR 115 CS	37-38				
COMMANDOR 116	38-40				
COMMANDOR 116 CS	41-43				
COMMANDOR 228	43-45				
COMMANDOR 228 CS	45-47				
CONSUL	48				
DOMINATOR 100, 105	49				
DOMINATOR 106	50				
DOMINATOR 108 HYDR	51-52				
DOMINATOR 108 MECH	53				
DOMINATOR 108 VX	53-54				
DOMINATOR 112	55-56				
DOMINATOR 114	57-58				
DOMINATOR 115	59-60				
DOMINATOR 116	61-62				
DOMINATOR 118	62-64				
DOMINATOR 118 HYDR	65-66				
DOMINATOR 118 MECH	67				
DOMINATOR 128 VX	68-69				
DOMINATOR 130	69				
DOMINATOR 140	70				
DOMINATOR 150	71				
DOMINATOR 203 MEGA	72-73				
DOMINATOR 204 MEGA	73-74				
DOMINATOR 208 MEGA	74-75				
DOMINATOR 218 MEGA	76-77				
DOMINATOR 38	77-78				
DOMINATOR 48	78				
DOMINATOR 48 SP	79				
DOMINATOR 56	80				
DOMINATOR 58	81				
DOMINATOR 58 SP	82				
DOMINATOR 66	83				
DOMINATOR 68	84-85				
DOMINATOR 68 R	85-86				
DOMINATOR 68 SR	86-87				
DOMINATOR 76	88				
DOMINATOR 78	89-90				
DOMINATOR 80	90-91				
DOMINATOR 85	91				
DOMINATOR 86	92				
DOMINATOR 88	92-93				
DOMINATOR 88 VX	94				
DOMINATOR 96	95				
DOMINATOR 98	96				
DOMINATOR 98 VX	97				
EUROPA	98				
JAGUAR 60, 675	99				
JAGUAR 675 HYDRO, 680	100				
JAGUAR 680 HYDRO, 682	101				
JAGUAR 682 SL, 682 S	102				
JAGUAR 685, 685 SL	103				
JAGUAR 690, 690 SL	104				
JAGUAR 695 SL, 70 SF, 71, 75	105				
JAGUAR 800, 820	106				
JAGUAR 830, 840, 85, 850	107				
JAGUAR 870, 890, 900	108				
LEXION 405	108-109				
LEXION 410	109-110				
LEXION 410 II	111-112				
LEXION 415	112-113				
LEXION 420 MONTANA	113-114				
LEXION 430	114-115				
LEXION 430 II	116-117				
LEXION 430 MONTANA	117-118				
LEXION 440	118-119				
LEXION 440 II	119-121				
LEXION 450 II MTS	121-122				
LEXION 450 TERRA	122-123				
LEXION 460	124-125				
LEXION 460 II	125-126				
LEXION 460 II MTS	127-128				
LEXION 460 TERRA	128-129				
LEXION 470	130-131				
LEXION 470 MONTANA	131-132				
LEXION 480	133-134				
LEXION 480 II	134-135				
LEXION 480 II MTS	135-136				
LEXION 480 TERRA	137-138				
LEXION 510	138-139				
LEXION 520 MONTANA	140-141				
LEXION 530	141-142				
LEXION 530 MONTANA	143-144				
LEXION 540	144-145				
LEXION 550 MONTANA	146-147				
LEXION 560	147-148				
LEXION 560 MONTANA	148-149				
LEXION 570	150-151				
LEXION 570 MONTANA	152-153				
LEXION 580	154-155				
LEXION 580 R AUSTRALIA	156-157				
LEXION 600	158-159				
MATADOR - GIGANT	160				
MATADOR - STANDARD	161				
MEDION 310	162				
MEDION 320	163				
MEDION 330	164-165				
MEDION 330 HYDRO	166				
MEDION 340	167				
MEGA 202	168-169				

Contents



MEGA 202 II	170-171	M 1620	229	D 4500	288
MEGA 203	172-173	M 1630	230	D 500, D 600	289
MEGA 203 II	173-175	M 2385	231	D 7000	290-291
MEGA 204	176-177	M 2480	232-233	D 7000 S	292-293
MEGA 204 II	177-179	M 2780	234	D 7200	294-295
MEGA 208	180-181	M 3280	235	D 7500	296-297
MEGA 208 II	182-183	M 3480	236	D 8000	298-299
MEGA 218	184-185	M 3540	237	D 8000 S	299-300
MEGA 218 II	186-187	M 3570	238	D 8400	301
MEGA 350	188-189	M 3578	239-240	D 8500	302-303
MEGA 350 TYP 835	190-191	M 3580	240	D 8700	304
MEGA 350 TYP 836	191-192	M 3610	241	D 8900	305
MEGA 360	192-193	M 3630	242-243	D 900	306
MEGA 360 TYP 845	194-195	M 3640	244-245	D 9000	307
MEGA 360 TYP 846	195-196	M 660	246-247	D 950	308
MEGA 360 TYP C12	196-197	M 750	248		
MEGA 370	198-199	M 770, M 88, M 88 S	249	FENDT	
MEGA 370 TYP 845	200-201	M 900	250-251	5250	309
MEGA 370 TYP 846	202-203	M 922	252-253	6300, 6330	310
MEGA 370 TYP C12	204-205	POWERLINER 4030	254	8300	311
MERCATOR	206	POWERLINER 4035	255		
MERCATOR 50	207	STARLINER 4040	256	FORTSCHRITT	
MERCATOR 60	208	STARLINER 4045	257	E 514	312
MERCATOR 75	209	TOPLINER 4060	258-259	E 516	313
MERCATOR S 70	210	TOPLINER 4065	260-261	E 516 B	314
MERCUR	211	TOPLINER 4070	262-263	E 517	315
OLDER MODELS, PROTECTOR	212	TOPLINER 4075	264-265	E 524, E 525	316
SENATOR	213	TOPLINER 4080	266-267		
SF	214	TOPLINER 4090	268-269	JOHN DEERE	
TUCANO 330/320	215	TOPLINER 8XL	270	330	317
TUCANO 340	216			430	318
TUCANO 430	217	DRONNINGBORG		530	319
TUCANO 450/440	218	D 1200	271	630	320
		D 1250	272	730	321
DEUTZ-FAHR		D 1500	273	930	322
100 Z	219	D 1600	274	940	323
M 1000	220	D 1650	275	950	324
M 1002	221	D 1800	276	952	325
M 1102	222	D 1900	277	955	326
M 1200	223	D 2250	278-279	960	327
M 1202	224	D 2500	279	965	328
M 1300	225	D 2600	280	970	329
M 1302	226	D 3000 S	281-283	975	330
M 1302 H	227	D 4000	283-285	985	331
M 1600	228	D 4000 S	285-288	1032	332

Contents

1042	333	9650	386	3650, 3700	431
1052	334	9660	387	3750, 3790	432
1055	335	9680, 9880, 9935	388	3850, 3890, 3900	433
1065	336	9980	389	3350 (EX AL 112), 3400 R	434
1068	337	1072 - 1075 - 1075 HYDRO 4	390-391	3450 (EX AL 132), 3500 R	435
1072	338	1075 HYDRO 4	392	3550 AL	436
1075	339	1085 - 1085 HYDRO 4	393	3550 R	437
1085	340	1166 - 1166 HYDRO 4	394-395	L 517	438
1088	341	1169 - 1169 HYDRO 4	395	L 521	439-440
1155	342	1174 - 1174 HYDRO 4	396-397	L 524	440-441
1157	343	1177 - 1177 HYDRO 4	398	L 624	441-442
1158	344	1188 - 1188 HYDRO 4	399	L 626	442-443
1170	345	4435 - 4435 HYDRO,		M 112, M 112 AL, M 120, M 132,	
2054	346-347	6600 SIDEHILL, 6700 S	400	M 150, M 152	443
2056	348-349	9500 SH	401	M 84, M 90, MX 300	444
2058	350-351	9510 SH	402		
2064	352-353	9550 SH	403	MASSEY FERGUSON	
2066	354-355	9560 STS	404	24, 27, 29, 31	445
2250	355	9570 STS	405	187	446
2254	356-357	965 HYDRO 4	406	206	446-447
2256	358-359	9650 CTS	407	240	447
2258	360-361	9650 STS	408	300	448
2264	362-363	9660 STS	409-410	307	448-449
2266	364-365	9670 STS	411-412	400	449
2270, 2280, 3300, 3430	365	9750 STS	413	440, 487, 500	450
4400, 4420	366	9760 STS	414	507, 510	451
4425, 4700	367	9770 STS	415	515	452
6600, 6602, 6610	368	9860 STS	416	520	453
6620, 6622, 6650, 6700, 6710	369	9870 STS	416-417	525	454
6750, 6810, 6950, 7700	370	CTS	418-419	530, 535	455
7720, 7721, 7722	371	CTS 2	420	540	456
8820	372	S 690	421	550	457
9400	373	T 550	422	560	458
9410	374	T 560	423	565	459
9450	375	T 660	424	620	460
9500	376	T 670	425	625	461
9501	377			660	462
9510	378	KRONE		665	463
9540	379	BIG X 1000, BIG X 500, BIG X 650	426	750	464-465
9550	380	BIG X 800	427	755	465-466
9560	381			760	467
9580	382	LAVERDA		850	468
9600	383	3300, 3400	428	855	469
9610	384	3500	429	860	470
9640	385	3550, 3600	430	865	471

Contents



3640, 8560	472	8080	514	TC 56	562
8570, 8780	473	9630, 9640, 9645	515	TC 57	563
9720, 186 (F)	474	1540 AL	516	TF 42	564
186 OLD, 206 OLD	475	CR 9060	517	TF 44	565
307 OLD, 400 - 500	476	CR 9060 ELEVATION	518	TF 46	566
400 - 500 OLD, 410 - 415	477	CR 9070 ELEVATION	519	TF 76	567
410 - 415 - 510 - 515 OLD, 410 - 510	478	CR 9080	520	TF 78, TR 70	568
487 - 506 - 507, 487 OLD	479	CR 9080 ELEVATION	521	TR 75, TR 85	569
506 OLD, 507 OLD	480	CR 960	522	TR 86, TR 95	570
520 - 525	480-481	CR 980	523	TR 96	571
520 OLD	481	CS 520	523-524	TR 97, TR 98	572
525 OLD	482	CS 540	524-525	TX 30	573
530 S, 620 - 625	483	CS 6050	526-527	TX 32	574-575
620 OLD	484	CS 6070	527-528	TX 34	576
625 OLD	485	CS 6080	528-529	TX 36	577
630 OLD, 630 S OLD	486	CS 6090	529-530	TX 62	578-579
685 OLD, 685 S OLD	487	CS 640	530-531	TX 63	579-580
750 OLD	488	CS 660	531-532	TX 64	580-581
760 - 765	489-490	CSX 7060	532-533	TX 65	581-582
760 OLD	490	CSX 7080	533-534	TX 66	582-584
86 (F), 86 OLD	491	CX 720	534-535	TX 67	584-585
87 (F), 87 OLD	492	CX 740	536-537	TX 68	585-586
CHALLENGER 660	493	CX 760	537-538		
CHALLENGER 660 B	494	CX 780	538-539	ROSTSELMASH	
CHALLENGER 670	495	CX 8030	539-540	ACROS 530	587
CHALLENGER 670 B	496	CX 8040	540-541	DON 1500 A	588-589
CHALLENGER 680 B	497	CX 8050	541-542	DON 1500 B	590-591
MF 27	498	CX 8060	542-543	DON 1500 M	592
MF 29	499-500	CX 8080	543-544	DON 680	593
MF 30	500-501	CX 8090	544-545	NIVA CK-5M-1-75(79)/77(81)	594-595
MF 31	501-502	CX 820	546-547	VECTOR	596-597
MF 32	503	CX 840	547-548		
MF 34	504	CX 860	548-549		
MF 38	505	CX 880	550-551		
		FX 300, FX 375	551		
NEW HOLLAND		FX 450, M 103, M 122	552		
1520	506	M 133, M 135	553		
1530	506-507	M 140, M 80, M 89	554		
1540	507	TC 5040	555		
1545, 1550	508	TC 5050	556		
8030, 8040	509	TC 5060	557		
8050	510	TC 5070	558		
8055	511	TC 5080	559		
8060	512	TC 52	560		
8070	513	TC 54	561		

BISO - Schrattenecker



No.	Application	OEM - PN	Set	Optibelt AP-Nr.	EAN
		600P06	1	1000196	4014486462333
		9351.0234.00	1	1000278	4014486464528
		600A14	1	1000575	4014486468847
		600A09	1	1000602	4014486469349
		600A17	1	1000615	4014486469530
		9351.0013.00	1	1000628	4014486469783
		600J07	1	1000674	4014486470468
		600J22	1	1000725	4014486471175
		9351.0046.00	1	1000730	4014486471229
		990601371026	1	1000735	4014486471311
		9351.0053.00	1	1000738	4014486471335
		600J20	1	1000756	4014486471571
		600A03	1	1000766	4014486471694
		600A07	1	1000769	4014486471748
		9351.0077.00	1	1000792	4014486472110
		9351.0082.00	1	1000798	4014486472172
		10VX00	1	1000801	4014486472202
		600A750	1	1000808	4014486472318
		9351.0108.00	1	1000836	4014486472639
		9351.0190.00	1	1001690	4014486486643
		9351.0193.00	1	1001692	4014486486674
		9351.0286.00	1	1001702	4014486486797

BISO - Schrattenecker



BISO - Schrattenecker
 BIZON
 CASE INTL. HARVESTER
 CLAAS
 DEUTZ-FAHR
 DRONNING-BORG
 FENDT
 FORTSCHRITT
 JOHN DEERE
 KRONE
 LAVERDA
 MASSEY FERGUSON
 NEW HOLLAND
 ROSTSELMASH

		93510204.00	1	1001710	4014486486889
		990606582526	1	1001714	4014486486940
		9351.0150.00	1	1002247	4014486478143
		9351.0154.00	1	1002251	4014486478181
		9351.0132.00	1	1003312	4014486477993
		9351.0183.00	1	1003326	4014486486087
		9351.0287.00	1	1003346	4014486486124
		600P03	1	1003384	4014486462272
		600P12	1	1003385	4014486462302
		600P01	1	1003392	4014486462678
		9351.0128.00	1	1003688	4014486477979
		9351.0136.00	1	1003690	4014486478068
		E020T16	1	1003884	4014486485813
		E020T15	1	1003888	4014486486575
		600J02	1	1003984	4014486518603
		600J03	1	1003985	4014486518610
		600J31	1	1003986	4014486518627
		9351.0084.00	1	1003987	4014486518962
		9351.0092.00	1	1003988	4014486518979
		9351-0102.00	1	1003989	4014486518986
		600A02B	1	1003990	4014486518672
		E020T14	1	1004005	4014486519389

BISO - Schrattenecker



No.	Application	OEM - PN	Set	Optibelt AP-Nr.	EAN
		T040H01	1	1004006	4014486519402
		E020T11	1	1004009	4014486519433
		9351.0196.00	1	1004012	4014486519440
		E020T13	1	1004013	4014486519471
		10VX00B	1	1004023	4014486519075
		10VX00A	1	1004024	4014486519082
		9351.0148.00	1	1004029	4014486519198
		990602570005	1	1004031	4014486519204
		600P04	1	1004033	4014486518450
		600P90	1	1004034	4014486518467
		84449765	1	1004043	4014486518924
		87311867	1	1004046	4014486518382
		87317063	1	1004047	4014486519068
		87330894	1	1004048	4014486519372
		87629601	1	1004050	4014486519785
		87629602	1	1004051	4014486519761
		84021591	2	1004053	4014486484038
		84058338	1	1004054	4014486519938
		0554099.1	1	1004073	4014486520361
		460189	1	1004083	4014486476972
		18 PJ 1244	1	1004104	4014486521009

BIZON TC 59, Z 110 BS



BISO - Schrottecker
 BIZON
 CASE INTL. HARVESTER
 CLAAS
 DEUTZ-FAHR
 DRONNING-BORG
 FENDT
 FORTSCHRITT
 JOHN DEERE
 KRONE
 LAVERDA
 MASSEY FERGUSON
 NEW HOLLAND
 ROSTSELMASH

No.	Application	OEM - PN	Set	Optibelt AP-Nr.	EAN
1		84021588	1	1000083	4014486519358
5		84026042	1	1001621	4014486485530
6		84996133	1	1001657	4014486486117
7		9818873	1	1003662	4014486490718
8		825117	1	1004147	4014486523287
9		9515076	1	1001416	4014486459234
10		9515075	1	1001428	4014486459364
2		51101255970	1	1000930	4014486473803
3		51101131525	1	1000123	4014486461350
4		51101131570	1	1000126	4014486461381
5		51101132800	1	1000158	4014486461800
6		51101171335	1	1000218	4014486462807
7		51101171375	1	1000221	4014486462852
8		51101171750	1	1003418	4014486463705
9		51101171981	1	1000267	4014486464269
10		51101172438	1	1000301	4014486465006
12		51102173550	1	1001651	4014486486032
14		51103172120	1	1001811	4014486488234
15		51103172380	1	1001827	4014486488487
16		51103172650	1	1001840	4014486488661
17		51103173062	1	1003637	4014486488883

BIZON Z 110 BS

CASE INTL. HARVESTER 80, 85, 95, 715, 782, 820

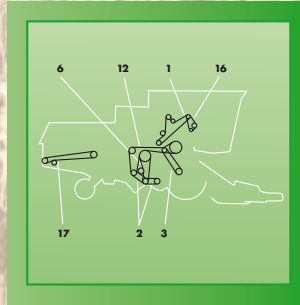
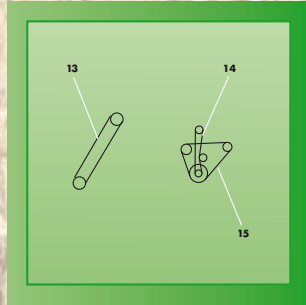
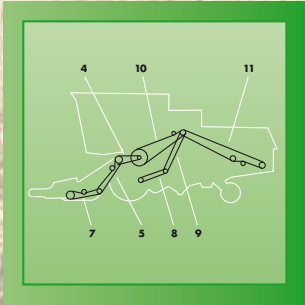

No.	Application	OEM - PN	Set	Optibelt AP-Nr.	EAN
18		51103173220	1	1003638	4014486488982
19		51104172270	1	1001952	4014486490572
20		51104173940	1	1003666	4014486491234
21		51651222360	1	1000615	4014486469530
22		51101222525	1	1000628	4014486469783
23		51101321750	1	1001413	4014486459203
24		51101622375	1	1001545	4014486460650
7	MAIN DRIVE FARMALL 400 450 460 560 (RIGHT HAND)	191305C1	1	1000654	4014486470178
6	MAIN DRIVE FARMALL 400 450 460 560 (RIGHT HAND)	191305C1	1	1000654	4014486470178
10	ALTERNATOR, FAN AND WATERPUMP DRIVE	59969C91	2	1003957	4014486495867
7	AUGER AND KNIFE DRIVE (112)	191305C1	1	1000654	4014486470178
2	FAN DRIVE	214522C1	1	1004125	4014486523072
5	AIR CONDITIONING COMPRESSOR DRIVE	280210C2	1	1000115	4014486461237
1	DRIVE 112-13/64-INCH	191305C1	1	1000654	4014486470178

CASE INTL. HARVESTER 915, 923, 933, 943

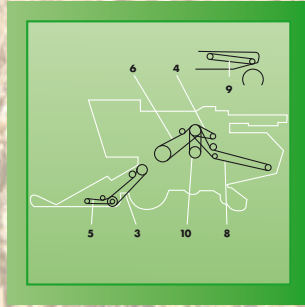
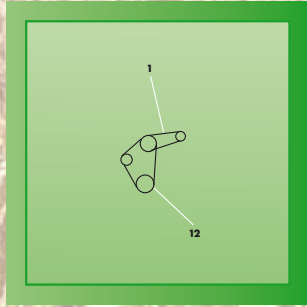
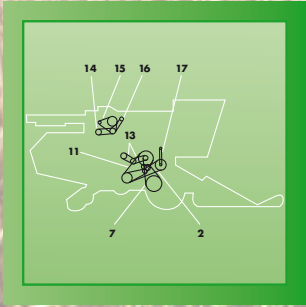

No.	Application	OEM - PN	Set	Optibelt AP-Nr.	EAN
9	STRAW SPREADER DRIVE	196371C1	1	1000423	4014486466867
5	UNLOADING JACKSHAFT DRIVE	3175336R1	1	1000684	4014486470628
6	CYLINDER	3175110R1	1	1001504	4014486460193
12	FAN - RETURN	3176321R1	1	1001367	4014486474817
5	UNLOADING JACKSHAFT DRIVE	3157994R1	1	1003542	4014486470895
6	CYLINDER	3175110R1	1	1001504	4014486460193
8	FEEDER - PLATFORM	3157741R1	1	1001098	4014486496802
9	TRACTION (UPPER)	3157094R1	1	1001117	4014486497021
12	FAN - RETURN	3176321R1	1	1001367	4014486474817
13	FEEDER - JACKSHAFT	3173480R1	1	1000913	4014486473629
1	INTERMEDIATE SHAFT	790522R1	1	1000578	4014486468939
6	SEPARATOR DRIVE	1407123R1	1	1001418	4014486459258
10	CUTTING TABLE DRIVE	3173115R1	1	1000914	4014486473636
11	FEEDER - PLATFORM	3167149R1	1	1001760	4014486487435
12	TRACTION DRIVE	3173717R1	1	1000725	4014486471175
15	FEEDER - JACKSHAFT	3173164R1	2	1002883	4014486471359
18	REEL DRIVE VARIABLE SPEED	1407123R1	1	1001418	4014486459258

CASE INTL. HARVESTER 953



No.	Application	OEM - PN	Set	Optibelt AP-Nr.	EAN
1	REEL DRIVE VARIABLE SPEED	1407123R1	1	1001418	4014486459258
2	CUTTING TABLE DRIVE	3167797R1	2	1002882	4014486471564
3	CUTTING TABLE DRIVE	3167149R1	1	1001760	4014486487435
4	MAIN DRIVE	3167653R2	1	1001999	4014486491258
5	DISCHARGE AUGER SHAFT	3167361R2	1	1000637	4014486469943
8	RETURN AUGER - SHAKER	3167489R1	1	1004101	4014486469165
11	RETURN ELEVATOR DRIVE	3170210R1	1	1000686	4014486470642
13	INTERMEDIATE SHAFT	790522R1	1	1000578	4014486468939
16	FAN DRIVE	1407123R1	1	1001418	4014486459258

CASE INTL. HARVESTER 1400



No.	Application	OEM - PN	Set	Optibelt AP-Nr.	EAN
2	AIR CONDITIONING COMPRESSOR DRIVE	874097C1	1	1000051	4014486483710
2	AIR CONDITIONING COMPRESSOR DRIVE	874097C1	1	1000051	4014486483710
3	STRAW SPREADER DRIVE	196371C1	1	1000423	4014486466867
5	STRAW CHOPPER DRIVE	181012C1	1	1001595	4014486485141
6	UNLOADING AUGER DRIVE	191290C1	1	1000708	4014486470956
6	UNLOADING AUGER DRIVE	191290C1	1	1000708	4014486470956
7	FEEDER DRIVE	192738C1	1	1003473	4014486519778
7	FEEDER DRIVE	192738C1	1	1003473	4014486519778
8	CLEANING FAN DRIVE	195396C2	1	1001417	4014486459241
8	CLEANING FAN DRIVE	195396C2	1	1001417	4014486459241
9	ELEVATOR DRIVE UNIT	186509C2	1	1001379	4014486474947
9	ELEVATOR DRIVE UNIT	186509C2	1	1001379	4014486474947
10	SEPARATOR DRIVE	191241C3	1	1001142	4014486490053
10	SEPARATOR DRIVE	191241C3	1	1001142	4014486490053
12	REEL DRIVE PUMP WITHOUT ROCK TRAP	197411C1	1	1000702	4014486470857
14	FAN JACKSHAFT DRIVE	191305C1	1	1000654	4014486470178
14	FAN JACKSHAFT DRIVE	191305C1	1	1000654	4014486470178
16	CLEANING UNIT DRIVE WITH STRAW CHOPPER	181055C1	1	1001374	4014486474886
33	AIR CONDITIONING COMPRESSOR DRIVE	280210C2	1	1000115	4014486461237

CASE INTL. HARVESTER 1420, 1460



No.	Application	OEM - PN	Set	Optibelt AP-Nr.	EAN
2	COMPRESSOR DRIVE	280210C2	1	1000115	4014486461237
4	RH SIDE DRIVE W/ STRAW CHOPPER	186509C2	1	1001379	4014486474947
4	RH SIDE DRIVE W/ DISCHARGE BEATER	183049C1	1	1001380	4014486474954
5	FAN DRIVE	599060R1	1	1001411	4014486459180
9	TAILINGS ELEV. DRIVE	674965R1	1	1000633	4014486469868
10	STRAW CHOPPER DRIVE	182945C1	1	1000737	4014486471328
13	AUXILIARY PUMP DRIVE	191288C2	1	1000614	4014486469523
2	AIR CONDITIONING COMPRESSOR DRIVE	874097C1	1	1000051	4014486483710
2	AIR CONDITIONING COMPRESSOR DRIVE	874097C1	1	1000051	4014486483710
3	STRAW SPREADER DRIVE	196371C1	1	1000423	4014486466867
5	STRAW CHOPPER DRIVE	181012C1	1	1001595	4014486485141
6	UNLOADING AUGER DRIVE	191290C1	1	1000708	4014486470956
6	UNLOADING AUGER DRIVE	191290C1	1	1000708	4014486470956
7	FEEDER DRIVE	192738C1	1	1003473	4014486519778
7	FEEDER DRIVE	192738C1	1	1003473	4014486519778
8	CLEANING FAN DRIVE	195396C2	1	1001417	4014486459241
8	CLEANING FAN DRIVE	195396C2	1	1001417	4014486459241
9	ELEVATOR DRIVE UNIT	186509C2	1	1001379	4014486474947
9	ELEVATOR DRIVE UNIT	186509C2	1	1001379	4014486474947
10	SEPARATOR DRIVE	191241C3	1	1001142	4014486490053
10	SEPARATOR DRIVE	191241C3	1	1001142	4014486490053

CASE INTL. HARVESTER 1460, 1480

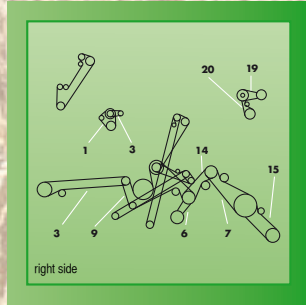
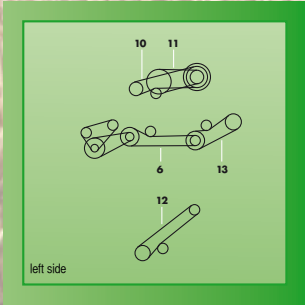

12	REEL DRIVE PUMP WITHOUT ROCK TRAP	197411C1	1	1000702	4014486470857
14	FAN JACKSHAFT DRIVE	191305C1	1	1000654	4014486470178
14	FAN JACKSHAFT DRIVE	191305C1	1	1000654	4014486470178
16	CLEANING UNIT DRIVE WITH STRAW CHOPPER	181055C1	1	1001374	4014486474886
2	AIR CONDITIONING COMPRESSOR DRIVE	874097C1	1	1000051	4014486483710
3	STRAW SPREADER DRIVE	196371C1	1	1000423	4014486466867
6	UNLOADING AUGER DRIVE	191291C1	1	1000723	4014486471151
8	CLEANING FAN DRIVE	195396C2	1	1001417	4014486459241
9	ELEVATOR DRIVE UNIT	186509C2	1	1001379	4014486474947
10	SEPARATOR DRIVE	191244C1	1	1001879	4014486489286
11	ROTOR VARIATOR DRIVE	244422A1	1	1001533	4014486460520
14	FAN JACKSHAFT DRIVE	188213C1	1	1000692	4014486470710
15	FEEDER JACKSHAFT DRIVE	1308489C2	1	1003573	4014486490091
16	CLEANING UNIT DRIVE WITH STRAW CHOPPER	181055C1	1	1001374	4014486474886

CASE INTL. HARVESTER 1620



No.	Application	OEM - PN	Set	Optibelt AP-Nr.	EAN
2	AIR CONDITIONING COMPRESSOR DRIVE	874097C1	1	1000051	4014486483710
2	AIR CONDITIONING COMPRESSOR DRIVE	280210C2	1	1000115	4014486461237
5	STRAW CHOPPER DRIVE	182945C1	1	1000737	4014486471328
7	FEEDER DRIVE	186509C2	1	1001379	4014486474947
8	CLEANING FAN DRIVE	599060R1	1	1001411	4014486459180
9	ELEVATOR DRIVE UNIT	183049C1	1	1001380	4014486474954
10	SEPARATOR DRIVE	191241C3	1	1001142	4014486490053
16	CLEANING UNIT DRIVE WITH STRAW CHOPPER	186509C2	1	1001379	4014486474947

CASE INTL. HARVESTER 1640

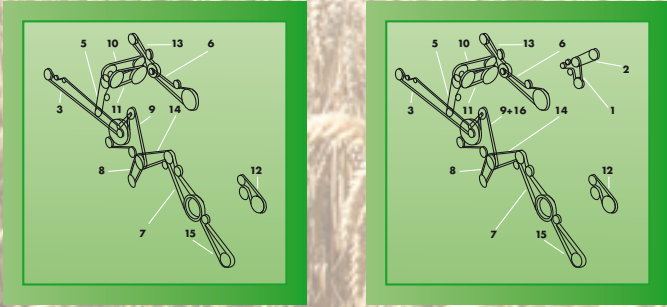

No.	Application	OEM - PN	Set	Optibelt AP-Nr.	EAN
1	ALTERNATOR, FAN AND WATERPUMP DRIVE	J911562	1	1004155	4014486523041
2	AIR CONDITIONING COMPRESSOR DRIVE	164550R2	1	1000102	4014486461046
3	STRAW SPREADER DRIVE	196371C1	1	1000423	4014486466867
5	STRAW CHOPPER DRIVE	1347157C1	1	1001610	4014486485387
6	UNLOADING AUGER DRIVE	191290C1	1	1000708	4014486470956
6	UNLOADING AUGER DRIVE	191290C1	1	1000708	4014486470956
7	FEEDER DRIVE WITHOUT ROCK TRAP	192738C1	1	1003473	4014486519778
7	FEEDER DRIVE WITHOUT ROCK TRAP	192738C1	1	1003473	4014486519778
8	CLEANING FAN DRIVE	195396C2	1	1001417	4014486459241
8	CLEANING FAN DRIVE	195396C2	1	1001417	4014486459241
9	ELEVATOR DRIVE UNIT	181055C1	1	1001374	4014486474886
9	ELEVATOR DRIVE UNIT	186509C2	1	1001379	4014486474947
10	SEPARATOR DRIVE	191241C3	1	1001142	4014486490053
10	SEPARATOR DRIVE	191241C3	1	1001142	4014486490053
12	REEL DRIVE PUMP	1321565C1	1	1002320	4014486480085
13	AUXILIARY PUMP DRIVE	1347387C1	1	1001602	4014486485240
14	FAN JACKSHAFT DRIVE	191305C1	1	1000654	4014486470178
14	FAN JACKSHAFT DRIVE	191305C1	1	1000654	4014486470178
16	CLEANING UNIT DRIVE WITH STRAW CHOPPER	181055C1	1	1001374	4014486474886

CASE INTL. HARVESTER 1644



No.	Application	OEM - PN	Set	Optibelt AP-Nr.	EAN
1	COMPRESSOR, A/C	1250587C1	1	1003476	4014486519242
6	AUXILLIARY PUMP DRIVE	1347387C1	1	1001602	4014486485240
10	CLEANING FAN JACKSHAFT DRIVE	191305C1	1	1000654	4014486470178
11	CLEANING FAN DRIVE	1541569C1	1	1003472	4014486518320
12	STRAW SPREADER DRIVE	196371C1	1	1000423	4014486466867
13	ELEVATOR DRIVE	181055C1	1	1001374	4014486474886
13	ELEVATOR DRIVE W/DISCHARGE BEATER	186509C2	1	1001379	4014486474947

CASE INTL. HARVESTER 1660

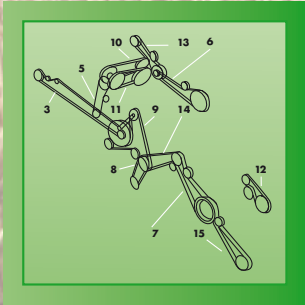

No.	Application	OEM - PN	Set	Optibelt AP-Nr.	EAN
2	AIR CONDITIONING COMPRESSOR DRIVE	164550R2	1	1000102	4014486461046
2	AIR CONDITIONING COMPRESSOR DRIVE	396829R1	1	1003475	4014486519228
3	STRAW SPREADER DRIVE	196371C1	1	1000423	4014486466867
3	STRAW SPREADER DRIVE	196371C1	1	1000423	4014486466867
5	STRAW CHOPPER DRIVE	1347157C1	1	1001610	4014486485387
6	UNLOADING AUGER DRIVE	191290C1	1	1000708	4014486470956
6	UNLOADING AUGER DRIVE	191290C1	1	1000708	4014486470956
7	FEEDER DRIVE WITHOUT ROCK TRAP	192738C1	1	1003473	4014486519778
7	FEEDER DRIVE WITHOUT ROCK TRAP	192738C1	1	1003473	4014486519778
8	CLEANING FAN DRIVE	195396C2	1	1001417	4014486459241
8	CLEANING FAN DRIVE	195396C2	1	1001417	4014486459241
8	CLEANING FAN DRIVE	1541569C1	1	1003472	4014486518320
9	ELEVATOR DRIVE UNIT	181055C1	1	1001374	4014486474886
9	ELEVATOR DRIVE UNIT	186509C2	1	1001379	4014486474947
10	SEPARATOR DRIVE	191241C3	1	1001142	4014486490053
10	SEPARATOR DRIVE	191241C3	1	1001142	4014486490053
12	REEL DRIVE PUMP	1321565C1	1	1002320	4014486480085
13	AUXILIARY PUMP DRIVE	1347387C1	1	1001602	4014486485240
14	FAN JACKSHAFT DRIVE	191305C1	1	1000654	4014486470178
14	FAN JACKSHAFT DRIVE	191305C1	1	1000654	4014486470178
16	CLEANING UNIT DRIVE WITH STRAW CHOPPER	181055C1	1	1001374	4014486474886
21	CHAFF SPREADER DRIVE (UPPER)	123305A1	1	1000432	4014486466997

CASE INTL. HARVESTER 1666, 1680

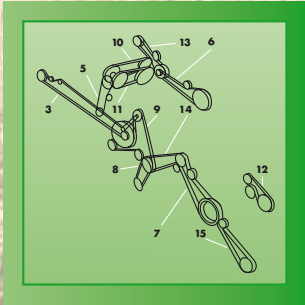

No.	Application	OEM - PN	Set	Optibelt AP-Nr.	EAN
1	COMPRESSOR, A/C	396829R1	1	1003475	4014486519228
6	AUXILLIARY PUMP DRIVE	1347387C1	1	1001602	4014486485240
10	CLEANING FAN JACKSHAFT DRIVE	191305C1	1	1000654	4014486470178
11	CLEANING FAN DRIVE	1541569C1	1	1003472	4014486518320
12	STRAW SPREADER DRIVE	196371C1	1	1000423	4014486466867
13	ELEVATOR DRIVE	181055C1	1	1001374	4014486474886
13	ELEVATOR DRIVE W/DISCHARGE BEATER	186509C2	1	1001379	4014486474947
2	AIR CONDITIONING COMPRESSOR DRIVE	396829R1	1	1003475	4014486519228
2	AIR CONDITIONING COMPRESSOR DRIVE	1250587C1	1	1003476	4014486519242
3	STRAW SPREADER DRIVE	196371C1	1	1000423	4014486466867
3	STRAW SPREADER DRIVE	196371C1	1	1000423	4014486466867
5	STRAW CHOPPER DRIVE	1315266C1	1	1001620	4014486485516
5	STRAW CHOPPER DRIVE	1315266C1	1	1001620	4014486485516
5	STRAW CHOPPER DRIVE	1347160C1	1	1001625	4014486485646
6	UNLOADING AUGER DRIVE	191291C1	1	1000723	4014486471151
6	UNLOADING AUGER DRIVE	191291C1	1	1000723	4014486471151
6	UNLOADING AUGER DRIVE	1989217C1	1	1000728	4014486471205
7	FEEDER DRIVE WITH ROCK TRAP	1315074C1	1	1001147	4014486490114
8	CLEANING FAN DRIVE	195396C2	1	1001417	4014486459241
8	CLEANING FAN DRIVE	195396C2	1	1001417	4014486459241
8	CLEANING FAN DRIVE	1541569C1	1	1003472	4014486518320

CASE INTL. HARVESTER 1680

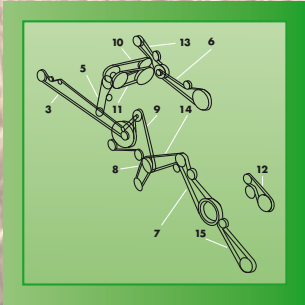

9	ELEVATOR DRIVE UNIT	186509C2	1	1001379	4014486474947
9	ELEVATOR DRIVE UNIT	186509C2	1	1001379	4014486474947
10	SEPARATOR DRIVE	1541702C1	1	1001145	4014486490084
10	SEPARATOR DRIVE	191244C1	1	1001879	4014486489286
11	ROTOR VARIATOR DRIVE	244422A1	1	1001533	4014486460520
11	ROTOR VARIATOR DRIVE	244422A1	1	1001533	4014486460520
12	REEL DRIVE PUMP (54.5)	1321565C1	1	1002320	4014486480085
12	REEL DRIVE PUMP	1321565C1	1	1002320	4014486480085
13	AUXILIARY PUMP DRIVE	1541700C1	1	1001600	4014486485226
13	AUXILIARY PUMP DRIVE	1347358C1	1	1001604	4014486485295
14	FAN JACKSHAFT DRIVE	188213C1	1	1000692	4014486470710
14	FAN JACKSHAFT DRIVE	188213C1	1	1000692	4014486470710
15	FEEDER JACKSHAFT DRIVE	1308489C2	1	1003573	4014486490091
15	FEEDER JACKSHAFT DRIVE	1308489C2	1	1003573	4014486490091
16	CLEANING UNIT DRIVE WITH STRAW CHOPPER	181055C1	1	1001374	4014486474886
16	CLEANING UNIT DRIVE WITH STRAW CHOPPER	181055C1	1	1001374	4014486474886
21	CHAFF SPREADER DRIVE (UPPER)	123305A1	1	1000432	4014486466997
22	CHAFF SPREADER DRIVE (LOWER)	123307A1	1	1002309	4014486479973

CASE INTL. HARVESTER 1688, 2144



No.	Application	OEM - PN	Set	Optibelt AP-Nr.	EAN
1	COMPRESSOR, A/C	396829R1	1	1003475	4014486519228
3	SEPARATOR DRIVE	1541702C1	1	1001145	4014486490084
5	GRAIN TANK UNLOADER DRIVE	1989217C1	1	1000728	4014486471205
6	AUXILLIARY PUMP DRIVE	1541700C1	1	1001600	4014486485226
7	STRAW CHOPPER DRIVE	1315266C1	1	1001620	4014486485516
8	FEEDER DRIVE W/ROCK TRAP	1315074C1	1	1001147	4014486490114
9	FEEDER JACKSHAFT DRIVE W/60" FEEDER	1308489C2	1	1003573	4014486490091
10	CLEANING FAN JACKSHAFT DRIVE	188213C1	1	1000692	4014486470710
11	CLEANING FAN DRIVE	1541569C1	1	1003472	4014486518320
12	STRAW SPREADER DRIVE	196371C1	1	1000423	4014486466867
13	ELEVATOR DRIVE	181055C1	1	1001374	4014486474886
13	ELEVATOR DRIVE W/DISCHARGE BEATER	186509C2	1	1001379	4014486474947
1	COMPRESSOR, A/C	1250587C1	1	1003476	4014486519242
6	AUXILLIARY PUMP DRIVE	124573A1	1	1001600	4014486485226
9	FEEDER JACKSHAFT DRIVE W/60" FEEDER	1308489C2	1	1003573	4014486490091
11	CLEANING FAN DRIVE	1541569C1	1	1003472	4014486518320
12	STRAW SPREADER DRIVE	196371C1	1	1000423	4014486466867
13	ELEVATOR DRIVE W/DISCHARGE BEATER	186509C2	1	1001379	4014486474947

CASE INTL. HARVESTER 2166



No.	Application	OEM - PN	Set	Optibelt AP-Nr.	EAN
2	AIR CONDITIONING COMPRESSOR DRIVE	396829R1	1	1003475	4014486519228
3	STRAW SPREADER DRIVE	196371C1	1	1000423	4014486466867
5	STRAW CHOPPER DRIVE	1347157C1	1	1001610	4014486485387
6	UNLOADING AUGER DRIVE	191290C1	1	1000708	4014486470956
7	FEEDER DRIVE WITHOUT ROCK TRAP	192738C1	1	1003473	4014486519778
8	CLEANING FAN DRIVE	1541569C1	1	1003472	4014486518320
9	ELEVATOR DRIVE UNIT	186509C2	1	1001379	4014486474947
10	SEPARATOR DRIVE	191241C3	1	1001142	4014486490053
13	AUXILIARY PUMP DRIVE	124572A1	1	1001599	4014486485202
14	FAN JACKSHAFT DRIVE	191305C1	1	1000654	4014486470178
15	FEEDER JACKSHAFT DRIVE	1308489C2	1	1003573	4014486490091
16	CLEANING UNIT DRIVE	181055C1	1	1001374	4014486474886
21	CHAFF SPREADER DRIVE (UPPER)	123305A1	1	1000432	4014486466997
22	CHAFF SPREADER DRIVE (LOWER)	123306A1	1	1002307	4014486479959

CASE INTL. HARVESTER 2188, 2365



No.	Application	OEM - PN	Set	Optibelt AP-Nr.	EAN
2	AIR CONDITIONING COMPRESSOR DRIVE	396829R1	1	1003475	4014486519228
3	STRAW SPREADER DRIVE	196371C1	1	1000423	4014486466867
5	STRAW CHOPPER DRIVE	1347160C1	1	1001625	4014486485646
7	FEEDER DRIVE WITH ROCK TRAP	1315074C1	1	1001147	4014486490114
8	CLEANING FAN DRIVE	1541569C1	1	1003472	4014486518320
9	ELEVATOR DRIVE UNIT	186509C2	1	1001379	4014486474947
10	SEPARATOR DRIVE	1541702C1	1	1001145	4014486490084
11	ROTOR VARIATOR DRIVE	244422A1	1	1001533	4014486460520
13	AUXILIARY PUMP DRIVE	124573A1	1	1001600	4014486485226
14	FAN JACKSHAFT DRIVE	188213C1	1	1000692	4014486470710
15	FEEDER JACKSHAFT DRIVE	1308489C2	1	1003573	4014486490091
16	CLEANING UNIT DRIVE	181055C1	1	1001374	4014486474886
21	CHAFF SPREADER DRIVE (UPPER)	123305A1	1	1000432	4014486466997
22	CHAFF SPREADER DRIVE (LOWER)	123307A1	1	1002309	4014486479973
2	AIR CONDITIONING COMPRESSOR DRIVE	396829R1	1	1003475	4014486519228
3	STRAW SPREADER DRIVE	196371C1	1	1000423	4014486466867
5	STRAW CHOPPER DRIVE	1347157C1	1	1001610	4014486485387
6	UNLOADING AUGER DRIVE	191290C1	1	1000708	4014486470956
7	FEEDER DRIVE WITHOUT ROCK TRAP	192738C1	1	1003473	4014486519778
8	CLEANING FAN DRIVE	301146A1	1	1003931	4014486520118
9	ELEVATOR DRIVE UNIT	186509C2	1	1001379	4014486474947

CASE INTL. HARVESTER 2365, 2366



No.	Application	OEM - PN	Set	Optibelt AP-Nr.	EAN
10	SEPARATOR DRIVE	191241C3	1	1001142	4014486490053
13	AUXILIARY PUMP DRIVE	124572A1	1	1001599	4014486485202
15	FEEDER JACKSHAFT DRIVE	1308489C2	1	1003573	4014486490091
16	CLEANING UNIT DRIVE	181055C1	1	1001374	4014486474886
2	AIR CONDITIONING COMPRESSOR DRIVE	396829R1	1	1003475	4014486519228
3	STRAW SPREADER DRIVE	196371C1	1	1000423	4014486466867
5	STRAW CHOPPER DRIVE	1347157C1	1	1001610	4014486485387
6	UNLOADING AUGER DRIVE	191290C1	1	1000708	4014486470956
7	FEEDER DRIVE WITHOUT ROCK TRAP	192738C1	1	1003473	4014486519778
8	CLEANING FAN DRIVE	301146A1	1	1003931	4014486520118
9	ELEVATOR DRIVE UNIT	186509C2	1	1001379	4014486474947
10	SEPARATOR DRIVE	191241C3	1	1001142	4014486490053
13	AUXILIARY PUMP DRIVE	124572A1	1	1001599	4014486485202
15	FEEDER JACKSHAFT DRIVE	1308489C2	1	1003573	4014486490091
16	CLEANING UNIT DRIVE	181055C1	1	1001374	4014486474886

CASE INTL. HARVESTER 2388, 1440E

No.	Application	OEM - PN	Set	Optibelt AP-Nr.	EAN
2	AIR CONDITIONING COMPRESSOR DRIVE	235414A1	1	1002515	4014486494297
3	ROTOR DRIVE	413159A1	1	1001535	4014486460544
5	SEPARATOR DRIVE	400427A1	1	1001216	4014486492422
6	AUXILIARY PUMP DRIVE	440498A3	1	1004116	4014486523867
7	DISCHARGE DRIVE GRAIN TANK	1989217C1	1	1000728	4014486471205
7	FEEDER JACKSHAFT DRIVE	402368A1	1	1001169	4014486491807
9	CLEANING FAN DRIVE	301146A1	1	1003931	4014486520118
10	CLEANING FAN - JACKSHAFT	317904A1	1	1004097	4014486518795
11	ELEVATOR DRIVE UNIT	186509C2	1	1001379	4014486474947
13	STRAW SPREADER DRIVE	196371C1	1	1000423	4014486466867
2	AIR CONDITIONING COMPRESSOR DRIVE	874097C1	1	1000051	4014486483710
3	STRAW SPREADER DRIVE	196371C1	1	1000423	4014486466867
5	STRAW CHOPPER DRIVE	181012C1	1	1001595	4014486485141
6	UNLOADING AUGER DRIVE	191290C1	1	1000708	4014486470956
7	FEEDER DRIVE	192738C1	1	1003473	4014486519778
8	CLEANING FAN DRIVE	195396C2	1	1001417	4014486459241
9	ELEVATOR DRIVE UNIT	186509C2	1	1001379	4014486474947
10	SEPARATOR DRIVE	191241C3	1	1001142	4014486490053
12	REEL DRIVE PUMP WITHOUT ROCK TRAP	197411C1	1	1000702	4014486470857
14	FAN JACKSHAFT DRIVE	191305C1	1	1000654	4014486470178
16	CLEANING UNIT DRIVE WITH STRAW CHOPPER	181055C1	1	1001374	4014486474886

CASE INTL. HARVESTER 1460E, 8-41, 8-51



No.	Application	OEM - PN	Set	Optibelt AP-Nr.	EAN
2	AIR CONDITIONING COMPRESSOR DRIVE	874097C1	1	1000051	4014486483710
3	STRAW SPREADER DRIVE	196371C1	1	1000423	4014486466867
5	STRAW CHOPPER DRIVE	181012C1	1	1001595	4014486485141
6	UNLOADING AUGER DRIVE	191290C1	1	1000708	4014486470956
7	FEEDER DRIVE	192738C1	1	1003473	4014486519778
8	CLEANING FAN DRIVE	195396C2	1	1001417	4014486459241
9	ELEVATOR DRIVE UNIT	186509C2	1	1001379	4014486474947
10	SEPARATOR DRIVE	191241C3	1	1001142	4014486490053
12	REEL DRIVE PUMP WITHOUT ROCK TRAP	197411C1	1	1000702	4014486470857
14	FAN JACKSHAFT DRIVE	191305C1	1	1000654	4014486470178
16	CLEANING UNIT DRIVE WITH STRAW CHOPPER	181055C1	1	1001374	4014486474886
2	MAIN DRIVE	793051R2	1	1000988	4014486498097
8	UNLOADING DRIVE	790522R1	1	1000578	4014486468939
2	PLATFORM DRIVE	3155127R1	1	1001091	4014486496734
3	MAIN DRIVE	1408761R1	4	1000372	4014486466355
4	JACKSHAFT - TRACTION DRIVE	3155178R1	1	1000749	4014486471465
9	RETURN ELEVATOR DRIVE	790522R1	1	1000578	4014486468939
11	HYDRAULIC PUMP DRIVE	769482R1	1	1002043	4014486475180

CASE INTL. HARVESTER 8-61-321, 8-71-431



No.	Application	OEM - PN	Set	Optibelt AP-Nr.	EAN
1	FEEDER AUGER - REEL VARIATOR DRIVE	1407123R1	1	1001418	4014486459258
2	JACKSHAFT - PLATFORM DRIVE	1410279R1	1	1003531	4014486470406
3	PLATFORM DRIVE	3155127R1	1	1001091	4014486496734
4	MAIN DRIVE	1408761R1	4	1000372	4014486466355
5	JACKSHAFT - TRACTION DRIVE	1410106R1	1	1001113	4014486496963
7	RETURN AUGER - FAN DRIVE	1408840R1	1	1001369	4014486474831
10	RETURN ELEVATOR DRIVE	790522R1	1	1000578	4014486468939
12	HYDRAULIC PUMP DRIVE	769482R1	1	1002043	4014486475180
1	FEEDER AUGER - REEL VARIATOR DRIVE	1407123R1	1	1001418	4014486459258
2	JACKSHAFT - PLATFORM DRIVE	1410279R1	1	1003531	4014486470406
3	PLATFORM DRIVE	1410462R1	1	1001095	4014486496772
4	MAIN DRIVE	1407035R1	4	1002790	4014486520057
5	JACKSHAFT - TRACTION DRIVE	1410106R1	1	1001113	4014486496963
7	RETURN AUGER - FAN DRIVE	1408840R1	1	1001369	4014486474831
7	RETURN AUGER - FAN DRIVE	3158811R1	1	1001370	4014486474848
10	RETURN ELEVATOR DRIVE	790522R1	1	1000578	4014486468939
12	HYDRAULIC PUMP DRIVE	769482R1	1	1002043	4014486475180

CASE INTL. HARVESTER 8-91-531



No.	Application	OEM - PN	Set	Optibelt AP-Nr.	EAN
1	FEEDER AUGER - REEL VARIATOR DRIVE	1407123R1	1	1001418	4014486459258
2	JACKSHAFT - PLATFORM DRIVE	3158455R1	1	1000904	4014486473506
3	PLATFORM DRIVE	1410462R1	1	1001095	4014486496772
4	MAIN DRIVE	1407035R1	4	1002790	4014486520057
5	JACKSHAFT - TRACTION DRIVE	3157094R1	1	1001117	4014486497021
7	RETURN AUGER - FAN DRIVE	3157600R1	1	1001371	4014486474855
8	TANK UNLOADER DRIVE	3157994R1	1	1003542	4014486470895
10	RETURN ELEVATOR DRIVE	790522R1	1	1000578	4014486468939

BISO - Schrattecker
 BIZON
 CASE INTL. HARVESTER
 CLAAS
 DEUTZ-FAHR
 DRONNING-BORG
 FENDT
 FORTSCHRITT
 JOHN DEERE
 KRONE
 LAVERDA
 MASSEY FERGUSON
 NEW HOLLAND
 ROSTSELMASH

CLAAS COLUMBUS

No.	Application	OEM - PN	Set	Optibelt AP-Nr.	EAN
1	BALER	506880.0	1	1000901	4014486473476
1	BALER	506940.0	1	1000934	4014486473858
2	ALTERNATOR DRIVE	624131.0	1	1000194	4014486462289
2	ALTERNATOR DRIVE	750624.0	1	1000197	4014486462340
2	ALTERNATOR DRIVE	750296.0	1	1000198	4014486462357
3	KNIFE DRIVE	756051.0	1	1003508	4014486469240
3	KNIFE DRIVE	801221.0	1	1004103	4014486473315
4	TANK UNLOADER DRIVE	756059.0	1	1000889	4014486520286
6	SPREADER GRAIN IN TANK	775698.0	1	1000272	4014486464429
7	PICK UP DRIVE	800309.0	1	1003435	4014486464719
8	SHAKER SHOE FANNING MILL	506023.0	1	1000928	4014486473780
9	THRESHING MACHINE	801222.0	4	1002798	4014486465808
10	TRACTION DRIVE	750294.0	1	1000251	4014486463897
11	TRACTION DRIVE	751112.0	1	1001161	4014486497427
12	SHAKER SHOE FANNING MILL	772658.0	1	1000935	4014486473865
12	SHAKER SHOE FANNING MILL	772660.0	1	1000936	4014486473872
13	STRAW WALKER ELEVATOR	773313.0	1	1000480	4014486467512
13	STRAW WALKER ELEVATOR	774100.0	1	1003481	4014486467963

CLAAS COMMANDOR 114

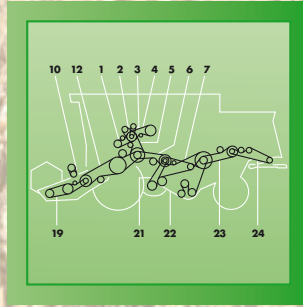
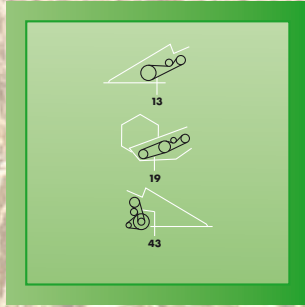
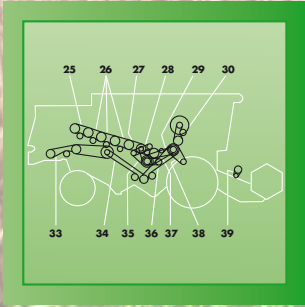

No.	Application	OEM - PN	Set	Optibelt AP-Nr.	EAN
1		629279.0	1	1001936	4014486490336
2		629002.1	1	1003395	4014486462715
3		629908.1	1	1002332	4014486478631
4		629763.0	1	1003593	4014486484977
5		629000.1	1	1003661	4014486490657
6		603337.0	1	1000662	4014486470260
10	TO 5.1 M CUTTING TABLE	670224.1	1	1001158	4014486497380
12		603017.3	2	1000833	4014486472592
13	FOR MAIZE PICKER	692149.0	1	1001852	4014486488869
13	FOR MAIZE PICKER	692150.0	1	1001857	4014486488920
16	FROM 6.0 M CUTTING TABLE	671013.1	1	1000676	4014486470482
19	TO 5.1 M CUTTING TABLE	713506.2	1	1000315	4014486465310
22		609762.0	1	1001713	4014486486919
24	FOR STRAW DISTRIBUTOR	640653.1	1	1000350	4014486466065
25		644014.1	1	1002319	4014486480078
26		644015.1	1	1002913	4014486484601
27		644016.1	1	1001800	4014486488104
29		064168.2	1	1003635	4014486488753
30		233843.1	1	1000237	4014486463408
33	FOR MAIZE	061872.0	2	1002867	4014486471939
34	FOR STRAW CHOPPER	061700.0	1	1003356	4014486486131
35		603247.1	1	1003626	4014486488111

CLAAS COMMANDOR 114, 114 CS

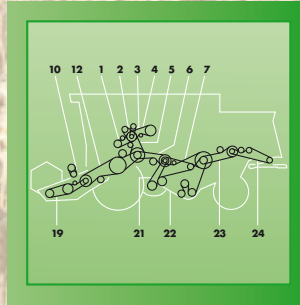
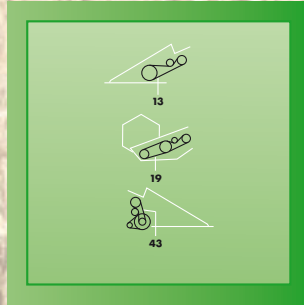
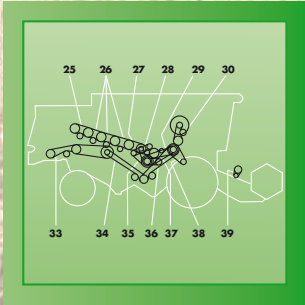

No.	Application	OEM - PN	Set	Optibelt AP-Nr.	EAN
37		644014.1	1	1002319	4014486480078
38	CYLINDER N=650-1500 RPM	628630.0	1	1001208	4014486497670
38	CYLINDER N=500-1400 RPM	644177.0	1	1001221	4014486497762
39	FROM 6.0 M CUTTING TABLE	670224.1	1	1001158	4014486497380
43		680334.1	1	1001819	4014486488364
1	GROUND DRIVE	629279.0	1	1001936	4014486490336
2	HYDRAULIC PUMP	629002.1	1	1003395	4014486462715
3	AIR CONDITIONER	629908.1	1	1002332	4014486478631
4	GRAIN TANK UNLOADING	629763.0	1	1003593	4014486484977
5	INTERMEDIATE DRIVE THRESHING MECHANISM	629000.1	1	1003661	4014486490657
6	INTERMEDIATE DRIVE BLOWER	603337.0	1	1000662	4014486470260
7	INTERMEDIATE DRIVE SIEVE PAN	644141.1	1	1000476	4014486467475
10	TO 5.1 M CUTTERBAR	670224.1	1	1001158	4014486497380
12	FEEDER HOUSING CUTTERBAR	603017.3	2	1000833	4014486472592
13	FOR CORN PICKER	692149.0	1	1001852	4014486488869
13	FOR CORN PICKER	692150.0	1	1001857	4014486488920
16	FROM 6.0 M CUTTERBAR	671013.1	1	1000676	4014486470482
19	TO 5.1 M CUTTERBAR	713506.2	1	1000315	4014486465310
21	BLOWER - VARIABLE SPEED DRIVE	603380.1	1	1001080	4014486498240
22	SIEVE BOX	609762.0	1	1001713	4014486486919
23	INTERMEDIATE DRIVE STRAW DISTRIBUTOR	506671.2	1	1000506	4014486467840

CLAAS COMMANDOR 114 CS



24	FOR STRAW SPREADER	640653.1	1	1000350	4014486466065
25	8. SEPARATOR DRUM	644014.1	1	1002319	4014486480078
26	3.5, 6.7 SEPARATOR DRUM	644015.1	1	1002913	4014486484601
27	4TH SEPARATOR DRUM	644016.1	1	1001800	4014486488104
29	INTERMEDIATE DRIVE DRUM VARIABLE SPEED	064168.2	1	1003635	4014486488753
30	TO No; 14900195	233843.1	1	1000237	4014486463408
30	ROTOR DRIVE	783430.1	1	1000238	4014486463422
33	CHOPPER, GRAIN	061701.2	1	1000790	4014486472066
33	CHOPPER, CORN	061872.0	2	1002867	4014486471939
34	INTERMEDIATE DRIVE II CHOPPER	061700.1	1	1003356	4014486486131
35	INTERMEDIATE DRIVE SEPARATOR DRUM	603247.1	1	1003626	4014486488111
36	INTERMEDIATE DRIVE I CHOPPER	061700.1	1	1003356	4014486486131
37	1STE AND 2ND SEPARATOR DRUM	644014.1	1	1002319	4014486480078
38	AT N 650 - 1500 MIN-1	628630.0	1	1001208	4014486497670
38	AT N 500 - 1400 MIN-1	644177.0	1	1001221	4014486497762
39	FROM 6.0 M CUTTERBAR	670224.1	1	1001158	4014486497380
43	FOR HPH - G PICKER	680334.1	1	1001819	4014486488364

CLAAS COMMANDOR 115

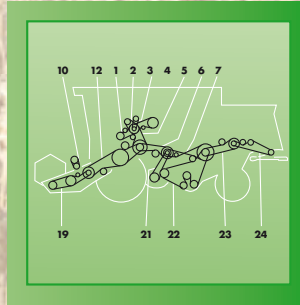
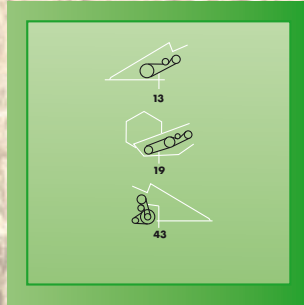
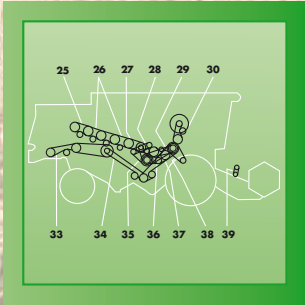

No.	Application	OEM - PN	Set	Optibelt AP-Nr.	EAN
2		629002.1	1	1003395	4014486462715
3		629908.1	1	1002332	4014486478631
4		629763.0	1	1003593	4014486484977
5		644018.1	1	1001243	4014486491982
6		603337.0	1	1000662	4014486470260
10	TO 5.1 M CUTTING TABLE	670224.1	1	1001158	4014486497380
12		603017.3	2	1000833	4014486472592
13	FOR MAIZE PICKER	692149.0	1	1001852	4014486488869
13	FOR MAIZE PICKER	692150.0	1	1001857	4014486488920
16	FROM 6.0 M CUTTING TABLE	671013.1	1	1000676	4014486470482
19	TO 5.1 M CUTTING TABLE	713506.2	1	1000315	4014486465310
22		609762.0	1	1001713	4014486486919
24	FOR STRAW DISTRIBUTOR	640653.1	1	1000350	4014486466065
25		644014.1	1	1002319	4014486480078
26		644015.1	1	1002913	4014486484601
27		644016.1	1	1001800	4014486488104
29		064168.2	1	1003635	4014486488753
30		233843.1	1	1000237	4014486463408
33	FOR MAIZE	061872.0	2	1002867	4014486471939
34	FOR STRAW CHOPPER	061700.0	1	1003356	4014486486131
35		603247.1	1	1003626	4014486488111
36	FOR STRAW CHOPPER	061700.0	1	1003356	4014486486131

CLAAS COMMANDOR 115, 115 CS

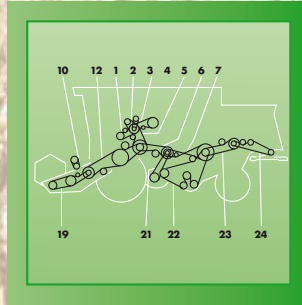
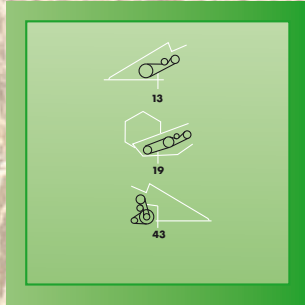
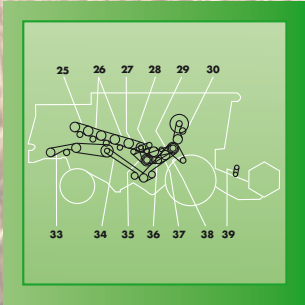

37		644014.1	1	1002319	4014486480078
38	CYLINDER N=650-1500 RPM	628630.0	1	1001208	4014486497670
38	CYLINDER N=500-1400 RPM	644177.0	1	1001221	4014486497762
39	FROM 6.0 M CUTTING TABLE	670224.1	1	1001158	4014486497380
43		680334.1	1	1001819	4014486488364
2	HYDRAULIC PUMP	629002.1	1	1003395	4014486462715
3	AIR CONDITIONER	629908.1	1	1002332	4014486478631
4	GRAIN TANK UNLOADING	629763.0	1	1003593	4014486484977
5	INTERMEDIATE DRIVE THRESHING MECHANISM	644018.1	1	1001243	4014486491982
6	INTERMEDIATE DRIVE BLOWER	603337.0	1	1000662	4014486470260
7	INTERMEDIATE DRIVE SIEVE PAN	644141.1	1	1000476	4014486467475
10	TO 5.1 M CUTTERBAR	670224.1	1	1001158	4014486497380
12	FEEDER HOUSING CUTTERBAR	603017.3	2	1000833	4014486472592
13	FOR CORN PICKER	692149.0	1	1001852	4014486488869
13	FOR CORN PICKER	692150.0	1	1001857	4014486488920
16	FROM 6.0 M CUTTERBAR	671013.1	1	1000676	4014486470482
19	TO 5.1 M CUTTERBAR	713506.2	1	1000315	4014486465310
21	BLOWER - VARIABLE SPEED DRIVE	603380.1	1	1001080	4014486498240
22	SIEVE BOX	609762.0	1	1001713	4014486486919
23	INTERMEDIATE DRIVE STRAW DISTRIBUTOR	506671.2	1	1000506	4014486467840
24	FOR STRAW SPREADER	640653.1	1	1000350	4014486466065

CLAAS COMMANDOR 115 CS, 116

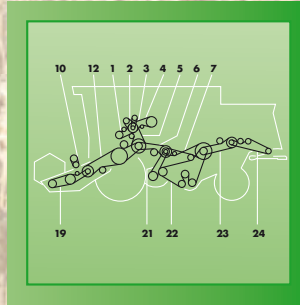
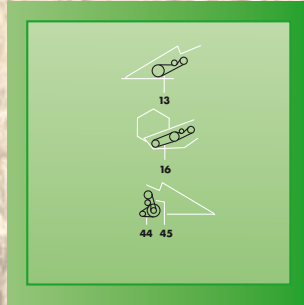
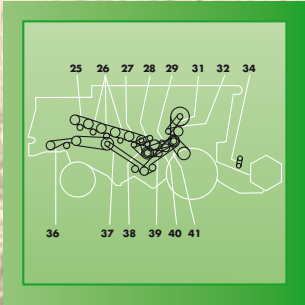

No.	Application	OEM - PN	Set	Optibelt AP-Nr.	EAN
25	8. SEPARATOR DRUM	644014.1	1	1002319	4014486480078
26	3.5, 6.7 SEPARATOR DRUM	644015.1	1	1002913	4014486484601
27	4TH SEPARATOR DRUM	644016.1	1	1001800	4014486488104
29	INTERMEDIATE DRIVE DRUM VARIABLE SPEED	064168.2	1	1003635	4014486488753
30	TO No; 15800110	233843.1	1	1000237	4014486463408
30	ROTOR DRIVE	783430.1	1	1000238	4014486463422
33	CHOPPER, GRAIN	061701.2	1	1000790	4014486472066
33	CHOPPER, CORN	061872.0	2	1002867	4014486471939
34	INTERMEDIATE DRIVE II CHOPPER	061700.1	1	1003356	4014486486131
35	INTERMEDIATE DRIVE SEPARATOR DRUM	603247.1	1	1003626	4014486488111
36	INTERMEDIATE DRIVE I CHOPPER	061700.1	1	1003356	4014486486131
37	1STE AND 2ND SEPARATOR DRUM	644014.1	1	1002319	4014486480078
38	AT N 650 - 1500 MIN-1	628630.0	1	1001208	4014486497670
38	AT N 500 - 1400 MIN-1	644177.0	1	1001221	4014486497762
39	FROM 6.0 M CUTTERBAR	670224.1	1	1001158	4014486497380
43	FOR HPH - G PICKER	680334.1	1	1001819	4014486488364
1	TRAVEL DRIVE (FROM NR. 15900371)	661092.1	1	1001238	4014486491920
2	HYDRAULIC PUMP DRIVE (FROM NR. 15900371)	633030.2	1	1000220	4014486462838
2	HYDRAULIC PUMP DRIVE (TO NR. 15900370)	629002.1	1	1003395	4014486462715
3	AIR CONDITIONING COMPRESSOR DRIVE	629908.1	1	1002332	4014486478631
4	TANK UNLOADING (FROM NR. 15900371)	661093.0	1	1001581	4014486484885

CLAAS COMMANDOR 116

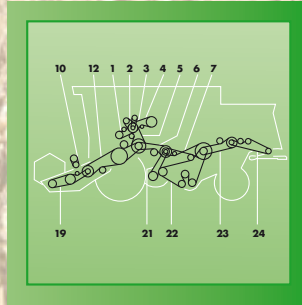
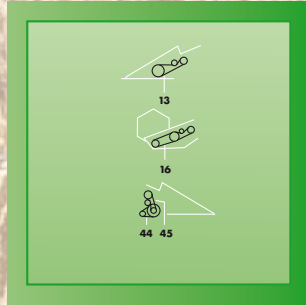
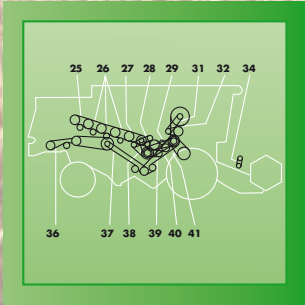

4	TANK UNLOADING (TO NR. 15900370)	629763.0	1	1003593	4014486484977
5	THRESHING CYLINDER (TO NR. 15900370)	644018.1	1	1001243	4014486491982
5	THRESHING MACHINE (FROM NR. 15900371)	644403.0	1	1001247	4014486492033
6	COUNTERSHAFT - FAN DRIVE	603337.0	1	1000662	4014486470260
7	SHAKER SHOE DRIVE (FROM NR. 15900371)	644141.1	1	1000476	4014486467475
10	REEL DRIVE BY 5.1 M CUTTING TABLE	670224.1	1	1001158	4014486497380
12	CONVEYOR SHAFT 1463 MM	603017.3	2	1000833	4014486472592
13	FOR MAIZE PICKER	692149.0	1	1001852	4014486488869
13	FOR MAIZE PICKER HINGED	692150.0	1	1001857	4014486488920
13	CUTTING TABLE DRIVE (MAIZE)	629142.0	1	1001954	4014486490596
16	CUTTING MECHANICAL FROM 6.0 M CUTTING TABLE	671013.1	1	1000676	4014486470482
19	CUTTING MECHANICAL BY 5.1 M CUTTING TABLE	713506.2	1	1000315	4014486465310
22	SHAKER SHOE DRIVE	609762.0	1	1001713	4014486486919
23	DISTRIBUTOR GRAIN	713506.2	1	1000315	4014486465310
24	STRAW DISTRIBUTOR	640653.1	1	1000350	4014486466065
25	SEPARATOR CYLINDER 8.	644014.1	1	1002319	4014486480078
26	SEPARATOR CYLINDER 3. 5. 6. AND 7	644015.1	1	1002913	4014486484601
27	SEPARATOR CYLINDER 4.	644016.1	1	1001800	4014486488104
28	COUNTERSHAFT - VARIATOR DRIVE	064168.2	1	1003635	4014486488753
31	ROTARY SIEVE DRIVE (TO NR. 15900370)	644267.0	1	1000243	4014486463613
32	ROTARY SIEVE DRIVE (TO NR. 15900150)	633030.2	1	1000220	4014486462838
32	ROTARY SIEVE COUNTERSHAFT NR. 15900151-15900370	233839.2	3	1003758	4014486463002

CLAAS COMMANDOR 116

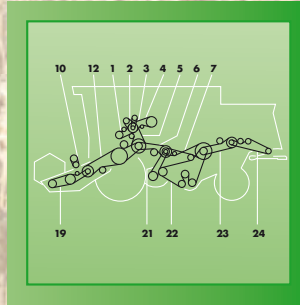
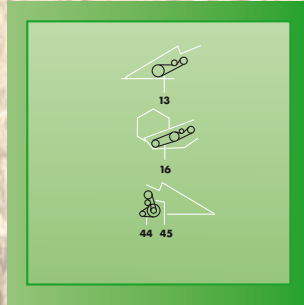
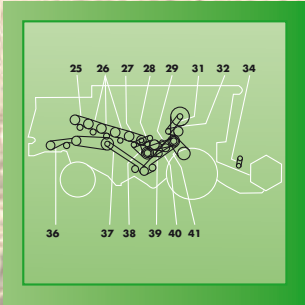

No.	Application	OEM - PN	Set	Optibelt AP-Nr.	EAN
34	REEL DRIVE FROM 6.0 M CUTTING TABLE	670224.1	1	1001158	4014486497380
36	STRAW CHOPPER (MAIZE)	061872.0	2	1002867	4014486471939
37	COUNTERSHAFT (2ND STAGE) - STRAW CHOPPER	061700.0	1	1003356	4014486486131
38	COUNTERSHAFT - STRAW STRIPPER DRUM	603247.1	1	1003626	4014486488111
39	COUNTERSHAFT (PRIMARY) - STRAW CHOPPER	061700.0	1	1003356	4014486486131
40	1. AND 2. SEPARATOR CYLINDER	644014.1	1	1002319	4014486480078
41	CYLINDER N=650-1500 RPM (TO NR. 15900310)	628630.0	1	1001208	4014486497670
41	THRESHING CYLINDER WITH TWO-STAGE DRIVE	644418.1	1	1001212	4014486497717
41	CYLINDER N=500-1400 RPM	644177.0	1	1001221	4014486497762
45		680334.1	1	1001819	4014486488364
46	ROTARY SIEVE (FROM NR. 15900371)	661345.0	1	1000160	4014486461824
47	ROTARY SIEVE COUNTERSHAFT (FROM NR. 15900371)	661245.0	1	1003377	4014486461435
48	DISTRIBUTOR - N=531 RPM (FROM NR. 70910057)	501925.0	1	1003449	4014486465501
48	DISTRIBUTOR - N=531 RPM (TO NR. 70910056)	802931.0	1	1003456	4014486465945
49	DISTRIBUTOR - N=676 RPM (TO NR. 70910056)	750288.0	4	1002794	4014486465853
49	DISTRIBUTOR - N=676 RPM (FROM NR. 70910057)	687046.0	1	1003448	4014486465495
50	ALTERNATOR DRIVE (TO NR. 15900370)	133528.0	1	1002560	4014486495102
50	ALTERNATOR DRIVE (FROM NR. 15900371)	133640.0	1	1003746	4014486495928

CLAAS COMMANDOR 116 CS



BISO - Schrattecker
BIZON
CASE INTL. HARVESTER
CLAAS
DEUTZ-FAHR
DRONNING-BORG
FENDT
FORTSCHRITT
JOHN DEERE
KRONE
LAVERDA
MASSEY FERGUSON
NEW HOLLAND
ROSTSELMASH

No.	Application	OEM - PN	Set	Optibelt AP-Nr.	EAN
1	GROUND DRIVE FROM NO. 15900371	661092.1	1	1001238	4014486491920
2	HYDRAULIC PUMP FROM NO. 15900371	633030.2	1	1000220	4014486462838
2	TO NO. 15900370	629002.1	1	1003395	4014486462715
3	AIR CONDITIONER	629908.1	1	1002332	4014486478631
4	GRAIN TANK UNLOADING FROM NO. 15900371	661093.0	1	1001581	4014486484885
4	TO NO. 15900370	629763.0	1	1003593	4014486484977
5	TO NO. 15900370	644018.1	1	1001243	4014486491982
5	INTERMEDIATE DRIVE THRESHING MECHANISM FROM NO. 15900371	644403.0	1	1001247	4014486492033
6	BLOWER INTERMEDIATE DRIVE	603337.0	1	1000662	4014486470260
7	SIEVE PAN INTERMEDIATE DRIVE FROM NO. 15900371	644141.1	1	1000476	4014486467475
7	TO NO. 15900370	603336.1	1	1000478	4014486467499
10	AT 5.1 M CUTTERBAR	670224.1	1	1001158	4014486497380
12	SHAFTS DISTANCE 1463 MM	603017.3	2	1000833	4014486472592
13	FOR CORN PICKER	692149.0	1	1001852	4014486488869
13	FOR CORN PICKER	692150.0	1	1001857	4014486488920
13	CORN PICKER FOLDING	629142.0	1	1001954	4014486490596
16	FROM 6.0 M CUTTERBAR	671013.1	1	1000676	4014486470482
19	AT 5.1 M CUTTERBAR	713506.2	1	1000315	4014486465310
21	FAN	603380.1	1	1001080	4014486498240
22	SIEVE BOX	609762.0	1	1001713	4014486486919
23	FOR CHAFF SPREADER	713506.2	1	1000315	4014486465310
23	FOR STRAW SPREADER	506671.2	1	1000506	4014486467840

CLAAS COMMANDOR 116 CS

No.	Application	OEM - PN	Set	Optibelt AP-Nr.	EAN
24	FOR STRAW SPREADER	640653.1	1	1000350	4014486466065
25	8. SEPARATOR DRUM	644014.1	1	1002319	4014486480078
26	3.5, 6.7. SEPARATOR DRUM	644015.1	1	1002913	4014486484601
27	4TH SEPARATOR DRUM	644016.1	1	1001800	4014486488104
28	INTERMEDIATE DRIVE VARIABLE SPEED DRIVE	064168.2	1	1003635	4014486488753
31	ROTOR DRIVE TO NO. 15900370	644267.0	1	1000243	4014486463613
32	TO NO. 15900150	633030.2	1	1000220	4014486462838
32	ROTOR INTERMEDIATE DRIVE NO 15900151 - 15900370	233839.2	3	1003758	4014486463002
34	FROM 6.0 M CUTTERBAR	670224.1	1	1001158	4014486497380
36	CHOPPER, GRAIN	061701.2	1	1000790	4014486472066
36	CHOPPER, CORN	061872.0	2	1002867	4014486471939
37	INTERMEDIATE DRIVE II CHOPPER	061700.1	1	1003356	4014486486131
38	INTERMEDIATE DRIVE SEPARATOR DRUM	603247.1	1	1003626	4014486488111
39	INTERMEDIATE DRIVE I CHOPPER	061700.1	1	1003356	4014486486131
40	1STE AND 2ND SEPARATOR DRUM	644014.1	1	1002319	4014486480078
41	TO NO. 15900310	628630.0	1	1001208	4014486497670
41	AT N = 650 - 1500 MIN-1 FROM NO. 15900581	661429.0	1	1001212	4014486497717
41	AT HIGH - LOW SPEED RANGE TRANSMISSION FROM NO. 15900581	661429.0	1	1001212	4014486497717
41	AT N 500 - 1500 MIN-1	661430.0	1	1001229	4014486497830
45	ROTOR DRIVE FROM NO. 15900371	680334.1	1	1001819	4014486488364
46	ROTOR INTERMEDIATE DRIVE FROM NO. 15900371	661345.0	1	1000160	4014486461824
47	ROTOR INTERMEDIATE DRIVE FROM NO. 15900371	661245.0	1	1003377	4014486461435

CLAAS COMMANDOR 116 CS, 228

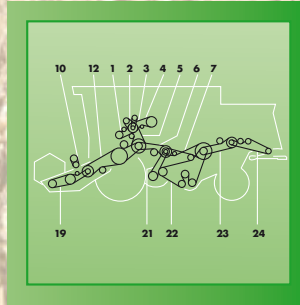
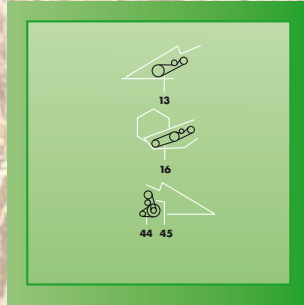
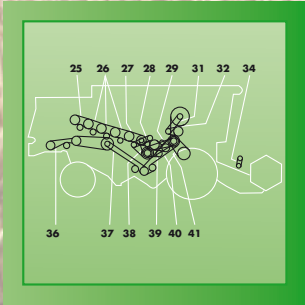

48	FOR CHAFF SPREADER FROM NO. 70910057 AT 531 MIN-1	501925.0	1	1003449	4014486465501
48	FOR CHAFF SPREADER TO NO. 70910056 AT 531 MIN-1	802931.0	1	1003456	4014486465945
49	FOR CHAFF SPREADER FROM NO. 70910057 AT 676 MIN-1	687046.1	1	1000323	4014486465471
49	FOR CHAFF SPREADER TO NO. 70910056 AT 676 MIN-1	750288.0	4	1002794	4014486465853
50	TO NO. 15900370	133528.0	1	1002560	4014486495102
50	FOR ALTERNATOR FROM NO. 15900371	133640.0	1	1003746	4014486495928
51	FOR WATERPUMP TO NO. 15900370	133630.1	2	1002961	4014486495058
52	RADIATOR CONCAVE SUCTION FROM NO. 15900371	644448.0	1	1000139	4014486461565
1	TRAVEL DRIVE (FROM NR. 15900371)	661092.1	1	1001238	4014486491920
2	HYDRAULIC PUMP DRIVE (FROM NR. 15900371)	633030.2	1	1000220	4014486462838
2	HYDRAULIC PUMP DRIVE (TO NR. 15900370)	629002.1	1	1003395	4014486462715
3	AIR CONDITIONING COMPRESSOR DRIVE	629908.1	1	1002332	4014486478631
4	TANK UNLOADING (FROM NR. 15900371)	661093.0	1	1001581	4014486484885
4	TANK UNLOADING (TO NR. 15900370)	629763.0	1	1003593	4014486484977
5	THRESHING CYLINDER (TO NR. 15900370)	644018.1	1	1001243	4014486491982
5	THRESHING MACHINE (FROM NR. 15900371)	644403.0	1	1001247	4014486492033
6	COUNTERSHAFT - FAN DRIVE	603337.0	1	1000662	4014486470260
7	SHAKER SHOE DRIVE (FROM NR. 15900371)	644141.1	1	1000476	4014486467475
10	REEL DRIVE BY 5.1 M CUTTING TABLE	670224.1	1	1001158	4014486497380
12	CONVEYOR SHAFT 1463 MM	603017.3	2	1000833	4014486472592
13	FOR MAIZE PICKER	692149.0	1	1001852	4014486488869

CLAAS COMMANDOR 228

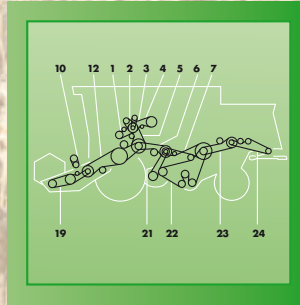
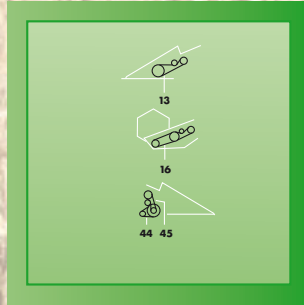
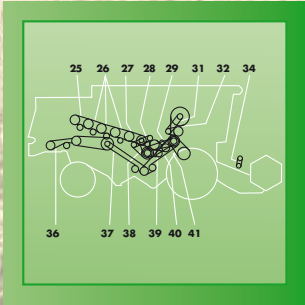

No.	Application	OEM - PN	Set	Optibelt AP-Nr.	EAN
13	FOR MAIZE PICKER HINGED	692150.0	1	1001857	4014486488920
13	CUTTING TABLE DRIVE (MAIZE)	629142.0	1	1001954	4014486490596
16	CUTTING MECHANICAL FROM 6.0 M CUTTING TABLE	671013.1	1	1000676	4014486470482
19	CUTTING MECHANICAL BY 5.1 M CUTTING TABLE	713506.2	1	1000315	4014486465310
22	SHAKER SHOE DRIVE	609762.0	1	1001713	4014486486919
23	DISTRIBUTOR GRAIN	713506.2	1	1000315	4014486465310
24	STRAW DISTRIBUTOR	640653.1	1	1000350	4014486466065
25	SEPARATOR CYLINDER 8.	644014.1	1	1002319	4014486480078
26	SEPARATOR CYLINDER 3. 5. 6. AND 7	644015.1	1	1002913	4014486484601
27	SEPARATOR CYLINDER 4.	644016.1	1	1001800	4014486488104
28	COUNTERSHAFT - VARIATOR DRIVE	064168.2	1	1003635	4014486488753
31	ROTARY SIEVE DRIVE (TO NR. 15900370)	644267.0	1	1000243	4014486463613
32	ROTARY SIEVE DRIVE (TO NR. 15900150)	633030.2	1	1000220	4014486462838
32	ROTARY SIEVE COUNTERSHAFT NR. 15900151-15900370	233839.2	3	1003758	4014486463002
34	REEL DRIVE FROM 6.0 M CUTTING TABLE	670224.1	1	1001158	4014486497380
36	STRAW CHOPPER (MAIZE)	061872.0	2	1002867	4014486471939
37	COUNTERSHAFT (2ND STAGE) - STRAW CHOPPER	061700.0	1	1003356	4014486486131
38	COUNTERSHAFT - STRAW STRIPPER DRUM	603247.1	1	1003626	4014486488111
39	COUNTERSHAFT (PRIMARY) - STRAW CHOPPER	061700.0	1	1003356	4014486486131
40	1. AND 2. SEPARATOR CYLINDER	644014.1	1	1002319	4014486480078
41	CYLINDER N=650-1500 RPM (TO NR. 15900310)	628630.0	1	1001208	4014486497670
41	THRESHING CYLINDER WITH TWO-STAGE DRIVE	644418.1	1	1001212	4014486497717

CLAAS COMMANDOR 228, 228 CS

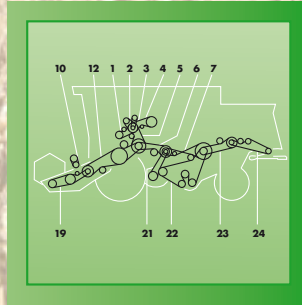
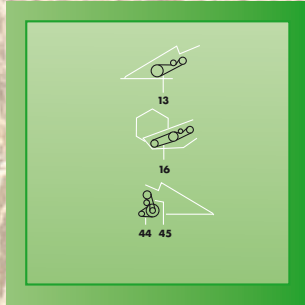
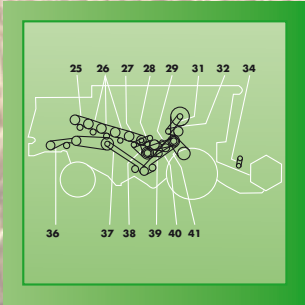

41	CYLINDER N=500-1400 RPM	644177.0	1	1001221	4014486497762
45		680334.1	1	1001819	4014486488364
46	ROTARY SIEVE (FROM NR. 15900371)	661345.0	1	1000160	4014486461824
47	ROTARY SIEVE COUNTERSHAFT (FROM NR. 15900371)	661245.0	1	1003377	4014486461435
48	DISTRIBUTOR - N=531 RPM (FROM NR. 70910057)	501925.0	1	1003449	4014486465501
48	DISTRIBUTOR - N=531 RPM (TO NR. 70910056)	802931.0	1	1003456	4014486465945
49	DISTRIBUTOR - N=676 RPM (TO NR. 70910056)	750288.0	4	1002794	4014486465853
49	DISTRIBUTOR - N=676 RPM (FROM NR. 70910057)	687046.0	1	1003448	4014486465495
50	ALTERNATOR DRIVE (TO NR. 15900370)	133528.0	1	1002560	4014486495102
50	ALTERNATOR DRIVE (FROM NR. 15900371)	133640.0	1	1003746	4014486495928
1	GROUND DRIVE FROM NO. 15900371	661092.1	1	1001238	4014486491920
2	HYDRAULIC PUMP FROM NO. 15900371	633030.2	1	1000220	4014486462838
2	TO NO. 15900370	629002.1	1	1003395	4014486462715
3	AIR CONDITIONER	629908.1	1	1002332	4014486478631
4	GRAIN TANK UNLOADING FROM NO. 15900371	661093.0	1	1001581	4014486484885
4	TO NO. 15900370	629763.0	1	1003593	4014486484977
5	TO NO. 15900370	644018.1	1	1001243	4014486491982
5	INTERMEDIATE DRIVE THRESHING MECHANISM FROM NO. 15900371	644403.0	1	1001247	4014486492033
6	BLOWER INTERMEDIATE DRIVE	603337.0	1	1000662	4014486470260
7	SIEVE PAN INTERMEDIATE DRIVE FROM NO. 15900371	644141.1	1	1000476	4014486467475
7	TO NO. 15900370	603336.1	1	1000478	4014486467499

CLAAS COMMANDOR 228 CS

No.	Application	OEM - PN	Set	Optibelt AP-Nr.	EAN
10	AT 5.1 M CUTTERBAR	670224.1	1	1001158	4014486497380
12	SHAFTS DISTANCE 1463 MM	603017.3	2	1000833	4014486472592
13	FOR CORN PICKER	692149.0	1	1001852	4014486488869
13	FOR CORN PICKER	692150.0	1	1001857	4014486488920
13	CORN PICKER FOLDING	629142.0	1	1001954	4014486490596
16	FROM 6.0 M CUTTERBAR	671013.1	1	1000676	4014486470482
19	AT 5.1 M CUTTERBAR	713506.2	1	1000315	4014486465310
21	FAN	603380.1	1	1001080	4014486498240
22	SIEVE BOX	609762.0	1	1001713	4014486486919
23	FOR CHAFF SPREADER	713506.2	1	1000315	4014486465310
23	FOR STRAW SPREADER	506671.2	1	1000506	4014486467840
24	FOR STRAW SPREADER	640653.1	1	1000350	4014486466065
25	8. SEPARATOR DRUM	644014.1	1	1002319	4014486480078
26	3.5, 6.7. SEPARATOR DRUM	644015.1	1	1002913	4014486484601
27	4TH SEPARATOR DRUM	644016.1	1	1001800	4014486488104
28	INTERMEDIATE DRIVE VARIABLE SPEED DRIVE	064168.2	1	1003635	4014486488753
31	ROTOR DRIVE TO NO. 15900370	644267.0	1	1000243	4014486463613
32	TO NO. 15900150	633030.2	1	1000220	4014486462838
32	ROTOR INTERMEDIATE DRIVE NO 15900151 - 15900370	233839.2	3	1003758	4014486463002
34	FROM 6.0 M CUTTERBAR	670224.1	1	1001158	4014486497380
36	CHOPPER, GRAIN	061701.2	1	1000790	4014486472066
36	CHOPPER, CORN	061872.0	2	1002867	4014486471939

CLAAS COMMANDOR 228 CS



37	INTERMEDIATE DRIVE II CHOPPER	061700.1	1	1003356	4014486486131
38	INTERMEDIATE DRIVE SEPARATOR DRUM	603247.1	1	1003626	4014486488111
39	INTERMEDIATE DRIVE I CHOPPER	061700.1	1	1003356	4014486486131
40	1STE AND 2ND SEPARATOR DRUM	644014.1	1	1002319	4014486480078
41	TO NO. 15900310	628630.0	1	1001208	4014486497670
41	AT N = 650 - 1500 MIN-1 FROM NO. 15900581	661429.0	1	1001212	4014486497717
41	AT HIGH - LOW SPEED RANGE TRANSMISSION FROM NO. 15900581	661429.0	1	1001212	4014486497717
41	AT N 500 - 1500 MIN-1	661430.0	1	1001229	4014486497830
45	ROTOR DRIVE FROM NO. 15900371	680334.1	1	1001819	4014486488364
46	ROTOR INTERMEDIATE DRIVE FROM NO. 15900371	661345.0	1	1000160	4014486461824
47	ROTOR INTERMEDIATE DRIVE FROM NO. 15900371	661245.0	1	1003377	4014486461435
48	FOR CHAFF SPREADER FROM NO. 70910057 AT 531 MIN-1	501925.0	1	1003449	4014486465501
48	FOR CHAFF SPREADER TO NO. 70910056 AT 531 MIN-1	802931.0	1	1003456	4014486465945
49	FOR CHAFF SPREADER FROM NO. 70910057 AT 676 MIN-1	687046.1	1	1000323	4014486465471
49	FOR CHAFF SPREADER TO NO. 70910056 AT 676 MIN-1	750288.0	4	1002794	4014486465853
50	TO NO. 15900370	133528.0	1	1002560	4014486495102
50	FOR ALTERNATOR FROM NO. 15900371	133640.0	1	1003746	4014486495928
51	FOR WATERPUMP TO NO. 15900370	133630.1	2	1002961	4014486495058
52	RADIATOR CONCAVE SUCTION FROM NO. 15900371	644448.0	1	1000139	4014486461565

CLAAS CONSUL

No.	Application	OEM - PN	Set	Optibelt AP-Nr.	EAN
1	CUTTING TABLE DRIVE	702509.0	1	1001090	4014486496727
2	CYLINDER DRIVE	702536.0	1	1001200	4014486497564
3	REEL DRIVE VARIABLE SPEED	778561.0	1	1001038	4014486496376
6	TRACTION VARIATOR DRIVE	702536.0	1	1001200	4014486497564
7	COUNTERSHAFT DRIVE	703314.0	1	1000296	4014486464887
8	UNLOADING GRAIN TANK	706087.0	1	1000365	4014486466263
9	STRAW SPREADER DRIVE	706829.0	1	1000524	4014486468045
10	HYDRAULIC PUMP DRIVE	713506.0	1	1000315	4014486465310
11	TRACTION DRIVE	720695.0	1	1000734	4014486471281
12	TURNING DRUM DRIVE	720696.0	1	1000467	4014486467383
12	TURNING DRUM DRIVE	720866.0	1	1003607	4014486485721
13	RADIATOR FAN DRIVE	721306.0	1	1002276	4014486478440
13	RADIATOR FAN DRIVE	721307.0	1	1002277	4014486478457
14	STRAW WALKER DRIVE	774099.0	1	1000511	4014486467895
15	FAN MILL VARIABLE SPEED	778561.0	1	1001038	4014486496376

CLAAS DOMINATOR 100, 105



BISO - Schrottecker
BIZON
CASE INTL. HARVESTER
CLAAS
DEUTZ-FAHR
DRONNING-BORG
FENDT
FORTSCHRITT
JOHN DEERE
KRONE
LAVERDA
MASSEY FERGUSON
NEW HOLLAND
ROSTSELMASH

No.	Application	OEM - PN	Set	Optibelt AP-Nr.	EAN
2	CUTTING TABLE DRIVE	672353.0	2	1002875	4014486472349
7	SHAKER SHOE FANNING MILL	672358.0	1	1000662	4014486470260
8	STRAW WALKER DRIVE	629036.0	1	1000515	4014486467949
10	FAN DRIVE VARIABLE SPEED	671209.0	1	1001039	4014486496383
12	AUGER (GRAIN)	629081.0	1	1000754	4014486471533
13	ELEVATOR DRIVE UNIT	629732.0	1	1000415	4014486466782
14	FEEDER ELEVATOR	501925.0	1	1003449	4014486465501
16	AIR INTAKE DRIVE	802931.0	1	1003456	4014486465945
18	CYLINDER VARIATOR DRIVE	629035.0	1	1001289	4014486520545
2	CUTTING TABLE DRIVE	672353.0	2	1002875	4014486472349
7	SHAKER SHOE FANNING MILL	672358.0	1	1000662	4014486470260
8	STRAW WALKER DRIVE	629036.0	1	1000515	4014486467949
10	FAN DRIVE VARIABLE SPEED	671209.0	1	1001039	4014486496383
12	AUGER (GRAIN)	629081.0	1	1000754	4014486471533
13	ELEVATOR DRIVE UNIT	629732.0	1	1000415	4014486466782
14	FEEDER ELEVATOR	501925.0	1	1003449	4014486465501
16	AIR INTAKE DRIVE	802931.0	1	1003456	4014486465945
18	CYLINDER VARIATOR DRIVE	629035.0	1	1001289	4014486520545

CLAAS DOMINATOR 106

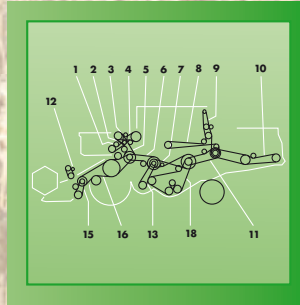
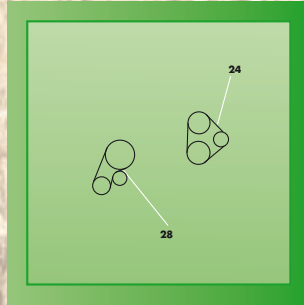
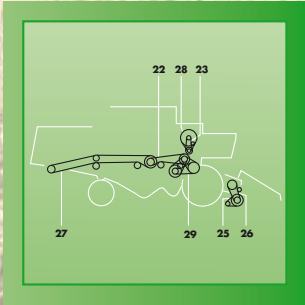

No.	Application	OEM - PN	Set	Optibelt AP-Nr.	EAN
1	MAIN (OM 401)	629279.0	1	1001936	4014486490336
2	OM 360	603378.0	1	1003388	4014486462524
2	OM 401	689175.0	1	1003391	4014486462654
4	GRAIN TANK (OM 401)	672351.0	1	1001570	4014486484731
6		603337.0	1	1000662	4014486470260
8	ELEVATOR DRIVE UNIT	629732.1	1	1000416	4014486466799
10		623427.1	1	1000409	4014486466720
18	SIEVE PAN (FROM NR. 9000439)	609762.0	1	1001713	4014486486919
18	SIEVE PAN (TO NR. 9000438)	603033.0	1	1003619	4014486486933
22	COUNTERSHAFT DRIVE	060306.2	1	1000723	4014486471151
23		603341.0	1	1003328	4014486463217
24	ENGINE (OM 401)	133528.0	1	1002560	4014486495102
24	ENGINE (OM 360)	685693.0	2	1003773	4014486495065
26		680334.1	1	1001819	4014486488364
27	STRAW CHOPPER DRIVE	061360.0	1	1000870	4014486473094
28	DRUM DRIVE	629035.0	1	1001289	4014486520545
28	DRUM DRIVE	629366.1	1	1001821	4014486488395
29	CYLINDER	603354.0	1	1001844	4014486488739

CLAAS DOMINATOR 108 HYDR

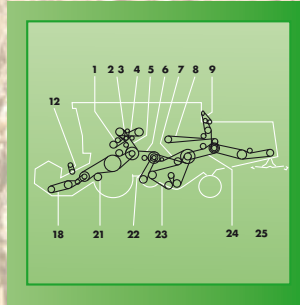
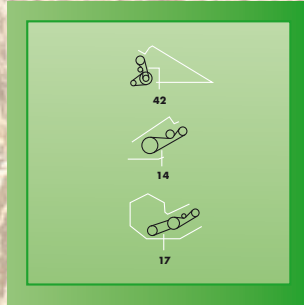
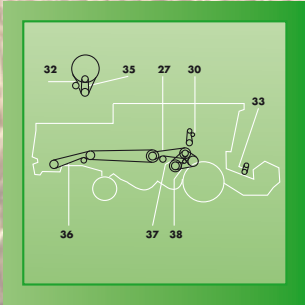

No.	Application	OEM - PN	Set	Optibelt AP-Nr.	EAN
1	FOR MERCEDES ENGINE OM 441 A	661092.1	1	1001238	4014486491920
1	FOR MERCEDES ENGINE OM 421	629279.0	1	1001936	4014486490336
1	FOR MERCEDES ENGINE OM 366 LA	644405.1	1	1001941	4014486490411
2		689175.0	1	1003391	4014486462654
3	FOR VAR. 7705	661114.0	1	1002336	4014486478686
4	FOR VAR. 7605	660409.0	1	1001575	4014486484809
4	FOR VAR. 7705	661093.0	1	1001581	4014486484885
4	TO NR. 09403057	629763.0	1	1003593	4014486484977
5	FROM NR. 09403058	644404.1	1	1003354	4014486490763
6		603337.0	1	1000662	4014486470260
8	TO NR. 09404032	629732.0	1	1000415	4014486466782
8	FROM NR. 09404033	644447.0	1	1000420	4014486466836
14	FOR MAIZE PICKER	692149.0	1	1001852	4014486488869
14	FOR MAIZE PICKER	692150.0	1	1001857	4014486488920
17	FOR 6.0 M - 9.0 M	671013.0	1	1000674	4014486470468
19	STRAW WALKER DRIVE	713506.0	1	1000315	4014486465310
21	SHAFT 1463 MM (TO NR. 09404032)	603017.0	2	1000833	4014486472592
23		609762.0	1	1001713	4014486486919
25		623427.0	1	1000410	4014486466737
30		783430.1	1	1000238	4014486463422
30		603341.0	1	1003328	4014486463217
32	TO NR. 09405334	821734.2	1	1000154	4014486461763

CLAAS DOMINATOR 108 HYDR

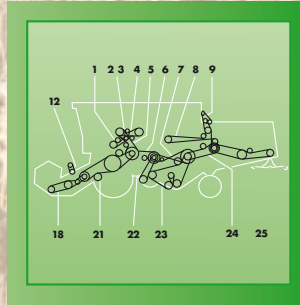
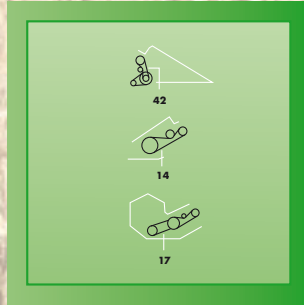
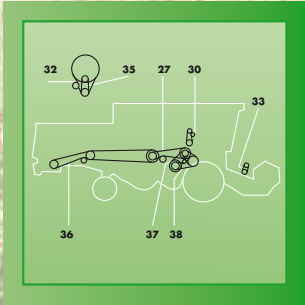

No.	Application	OEM - PN	Set	Optibelt AP-Nr.	EAN
32	FROM NR. 09405335	661345.0	1	1000160	4014486461824
32	FOR RABA - ENGINE	783876.0	1	1002091	4014486475845
35	FOR RABA - ENGINE	629764.0	1	1000097	4014486460964
35	FOR OM 366 LA	657793.0	1	1000107	4014486461114
35	FOR OM 366 LA	661244.0	1	1000125	4014486461374
35	FOR MERCEDES ENGINE OM 441 A	661245.0	1	1003377	4014486461435
36	CHOPPER DRIVE (MAIZE)	061214.0	1	1000868	4014486473070
36	CHOPPER DRIVE (GRAIN) (TO NR. 09403057)	061360.0	1	1000870	4014486473094
37	FROM NR. 09403058	609823.0	1	1001225	4014486497809
37	TO NR. 09403057	629035.0	1	1001289	4014486520545
38	VAR. 7818	661298.0	1	1001630	4014486485738
38	FOR N=650-1500 RPM	603354.0	1	1001844	4014486488739
38	FOR N=510-1220 RPM	629510.1	1	1003634	4014486488623
43	FOR AIR EXHAUST	644448.0	1	1000139	4014486461565

CLAAS DOMINATOR 108 MECH, 108 VX



No.	Application	OEM - PN	Set	Optibelt AP-Nr.	EAN
1		689175.0	1	1003391	4014486462654
5		603337.0	1	1000662	4014486470260
7	ELEVATOR DRIVE UNIT	629732.0	1	1000415	4014486466782
7	FROM NR. 09404033	644447.0	1	1000420	4014486466836
13	FOR MAIZE PICKER	692149.0	1	1001852	4014486488869
13	FOR MAIZE PICKER	692150.0	1	1001857	4014486488920
16	FOR 6.0 M - 9.0 M	671013.0	1	1000674	4014486470468
18	FOR 3.9 M - 5.1 M	713506.0	1	1000315	4014486465310
20	SHAFT BASE 1177 MM	629836.0	1	1000746	4014486471427
20	SHAFT 1306 MM	603290.0	2	1002869	4014486471663
22		609822.0	1	1001854	4014486488890
23		609823.0	1	1001225	4014486497809
25		609762.0	1	1001713	4014486486919
27		623427.0	1	1000410	4014486466737
32	FROM NR. 09400751	783430.1	1	1000238	4014486463422
32	TO NR. 09400750	603341.0	1	1003328	4014486463217
36	CHOPPER DRIVE (MAIZE)	061214.0	1	1000868	4014486473070
36	CHOPPER DRIVE (GRAIN) (TO NR. 09403057)	061360.0	1	1000870	4014486473094
37		628630.0	1	1001208	4014486497670
1		544049.0	1	1001939	4014486490367
2		767057.1	1	1003333	4014486462609

CLAAS DOMINATOR 108 VX

No.	Application	OEM - PN	Set	Optibelt AP-Nr.	EAN
3		629908.1	1	1002332	4014486478631
4		660409.0	1	1001575	4014486484809
5		644404.1	1	1003354	4014486490763
6		603337.0	1	1000662	4014486470260
7		644141.1	1	1000476	4014486467475
8		644447.0	1	1000420	4014486466836
9		623427.1	1	1000409	4014486466720
11		785341.0	1	1000295	4014486464870
11		066034.0	1	1000302	4014486465037
13		061214.0	1	1000868	4014486473070
13		061353.1	1	1000870	4014486473094
14		603380.1	1	1001080	4014486498240
15		609762.0	1	1001713	4014486486919
19		506671.2	1	1000506	4014486467840
20		661345.0	1	1000160	4014486461824
21	MERCEDES ENGINE OM 366L	661244.0	1	1000125	4014486461374
21	MERCEDES ENGINE OM 441	661245.0	1	1003377	4014486461435
22		644448.0	1	1000139	4014486461565
23		609823.0	1	1001225	4014486497809
24		661298.0	1	1001630	4014486485738
24		661220.1	1	1003340	4014486488807

CLAAS DOMINATOR 112

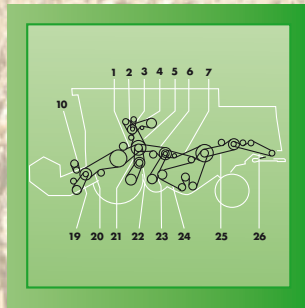
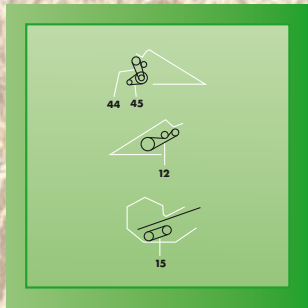
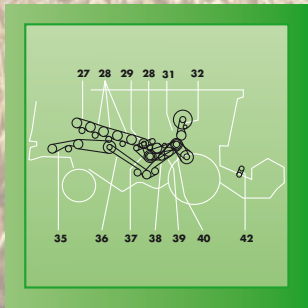

No.	Application	OEM - PN	Set	Optibelt AP-Nr.	EAN
1		673638.1	1	1001099	4014486496819
2		689175.0	1	1003391	4014486462654
3		629908.1	1	1002332	4014486478631
6		603337.0	1	1000662	4014486470260
12	FOR MAIZE PICKER	692149.0	1	1001852	4014486488869
12	FOR MAIZE PICKER	692150.0	1	1001857	4014486488920
15	FROM 6.0 M CUTTING TABLE	671013.1	1	1000676	4014486470482
15	FOR SOJA CUTTING TABLE	644209.0	1	1000699	4014486470826
19	TO 5.1 M CUTTING TABLE	629214.1	1	1002317	4014486480054
20		629836.0	1	1000746	4014486471427
21		609822.0	1	1001854	4014486488890
22		609823.0	1	1001225	4014486497809
24		609762.0	1	1001713	4014486486919
26		640653.1	1	1000350	4014486466065
27		644014.1	1	1002319	4014486480078
29		644016.1	1	1001800	4014486488104
31		064168.2	1	1003635	4014486488753
35	FOR MAIZE	061872.0	2	1002867	4014486471939
36	FOR STRAW CHOPPER	061700.0	1	1003356	4014486486131
37		603247.1	1	1003626	4014486488111
38	FOR STRAW CHOPPER	061700.0	1	1003356	4014486486131
39		644014.1	1	1002319	4014486480078

CLAAS DOMINATOR 112

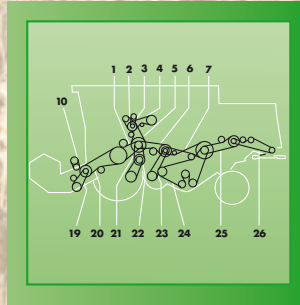
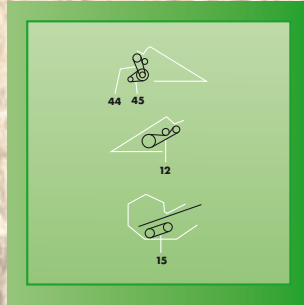
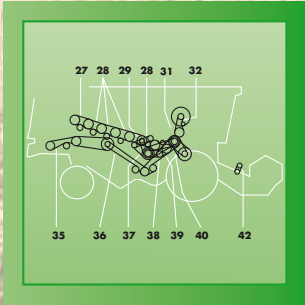

No.	Application	OEM - PN	Set	Optibelt AP-Nr.	EAN
40	CYLINDER N=500-1400 RPM	644177.0	1	1001221	4014486497762
40	CYLINDER N=650-1500 RPM	603015.1	1	1001503	4014486460186
44		680334.1	1	1001819	4014486488364

CLAAS DOMINATOR 114

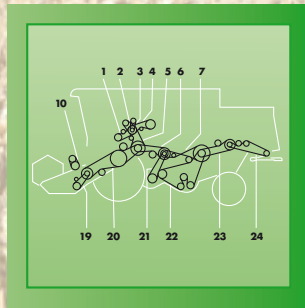
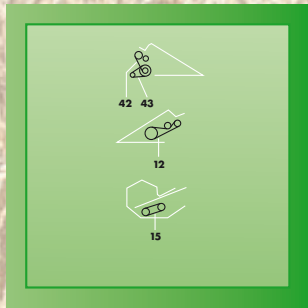
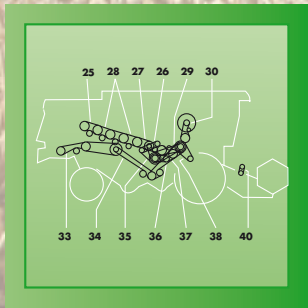

No.	Application	OEM - PN	Set	Optibelt AP-Nr.	EAN
1		629279.0	1	1001936	4014486490336
2		629002.1	1	1003395	4014486462715
3	TO NR. 14200046	621903.1	1	1002041	4014486475166
3	FROM NR. 14200047	629908.1	1	1002332	4014486478631
4		629763.0	1	1003593	4014486484977
6		603337.0	1	1000662	4014486470260
12	FOR MAIZE PICKER	692149.0	1	1001852	4014486488869
12	FOR MAIZE PICKER	692150.0	1	1001857	4014486488920
15	FROM 6.0 M CUTTING TABLE	671013.1	1	1000676	4014486470482
15	FOR SOJA CUTTING TABLE	644209.0	1	1000699	4014486470826
19	TO 5.7 M CUTTING TABLE	629214.1	1	1002317	4014486480054
20		603017.3	2	1000833	4014486472592
22		609762.0	1	1001713	4014486486919
24	FOR STRAW DISTRIBUTOR	640653.1	1	1000350	4014486466065
26		644015.1	1	1002913	4014486484601
27		644016.1	1	1001800	4014486488104
29		064168.2	1	1003635	4014486488753
30	FROM NR. 14200177	233843.1	1	1000237	4014486463408
30	TO NR. 14200176	603341.0	1	1003328	4014486463217
33	FOR MAIZE	061872.0	2	1002867	4014486471939
34	FOR STRAW CHOPPER	061700.0	1	1003356	4014486486131
35		603247.1	1	1003626	4014486488111

CLAAS DOMINATOR 114

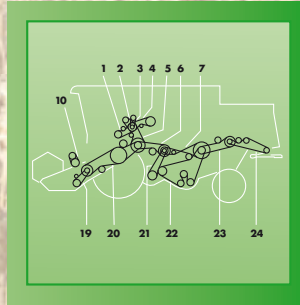
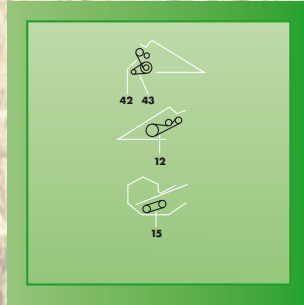
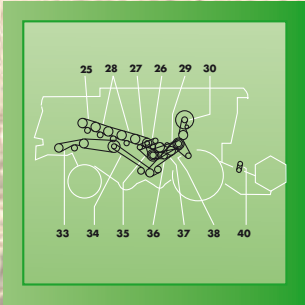

No.	Application	OEM - PN	Set	Optibelt AP-Nr.	EAN
36	FOR STRAW CHOPPER	061700.0	1	1003356	4014486486131
38	CYLINDER N=500-1400 RPM	644177.0	1	1001221	4014486497762
38	CYLINDER N=650-1500 RPM	603015.1	1	1001503	4014486460186
42		680334.1	1	1001819	4014486488364

CLAAS DOMINATOR 115

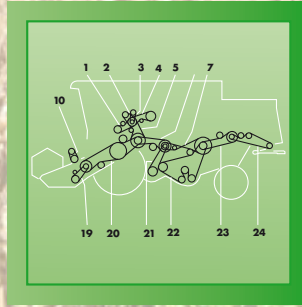
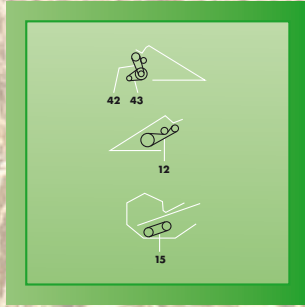
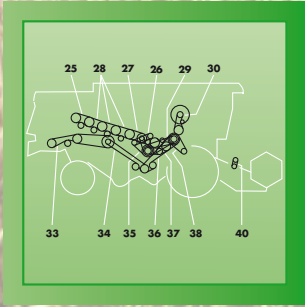

No.	Application	OEM - PN	Set	Optibelt AP-Nr.	EAN
1		629763.0	1	1003593	4014486484977
2		629002.1	1	1003395	4014486462715
3		629908.1	1	1002332	4014486478631
6		603337.0	1	1000662	4014486470260
12	FOR MAIZE PICKER	692149.0	1	1001852	4014486488869
12	FOR MAIZE PICKER	692150.0	1	1001857	4014486488920
15	FROM 6.0 M CUTTING TABLE	671013.1	1	1000676	4014486470482
15	FOR SOJA CUTTING TABLE	644209.0	1	1000699	4014486470826
19	TO 5.1 M CUTTING TABLE	629214.1	1	1002317	4014486480054
20		603017.3	2	1000833	4014486472592
22		609762.0	1	1001713	4014486486919
24	FOR STRAW DISTRIBUTOR	640653.1	1	1000350	4014486466065
25		644014.1	1	1002319	4014486480078
26		644015.1	1	1002913	4014486484601
27		644016.1	1	1001800	4014486488104
29		064168.2	1	1003635	4014486488753
30		233843.1	1	1000237	4014486463408
33	FOR MAIZE	061872.0	2	1002867	4014486471939
34	FOR STRAW CHOPPER	061700.0	1	1003356	4014486486131
35		603247.1	1	1003626	4014486488111
36	FOR STRAW CHOPPER	061700.0	1	1003356	4014486486131
37		644014.1	1	1002319	4014486480078

CLAAS DOMINATOR 115

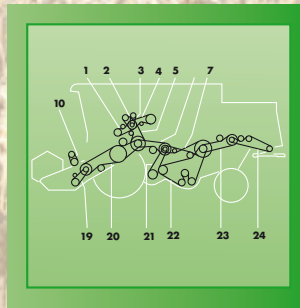
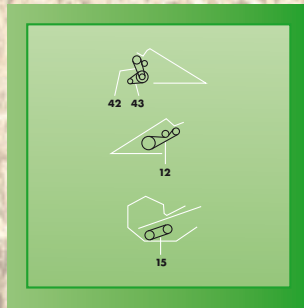
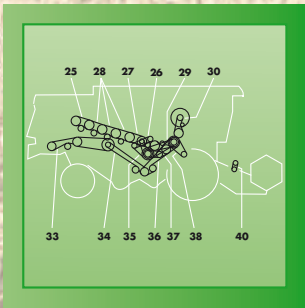

No.	Application	OEM - PN	Set	Optibelt AP-Nr.	EAN
38	CYLINDER N=500-1400 RPM	644177.0	1	1001221	4014486497762
38	CYLINDER N=650-1500 RPM	603015.1	1	1001503	4014486460186
42		680334.1	1	1001819	4014486488364

CLAAS DOMINATOR 116

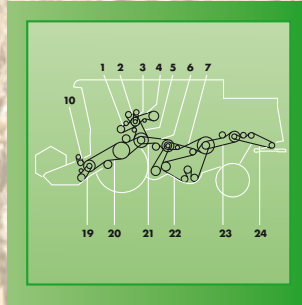
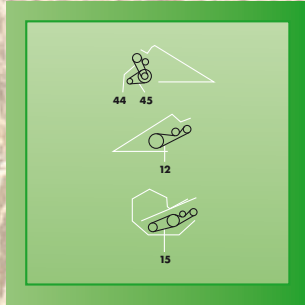
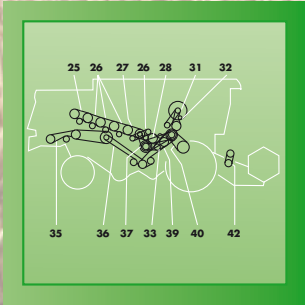

No.	Application	OEM - PN	Set	Optibelt AP-Nr.	EAN
2	HYDRAULIC PUMP DRIVE (TO NR. 14400299)	689175.0	1	1003391	4014486462654
2	HYDRAULIC PUMP DRIVE (FROM NR. 14400300)	629002.1	1	1003395	4014486462715
3	TO NR. 14400199	621903.1	1	1002041	4014486475166
3	FROM NR. 14400200	629908.1	1	1002332	4014486478631
4	DRIVE GRAIN TANK	629763.0	1	1003593	4014486484977
6		603337.0	1	1000662	4014486470260
12	FOR MAIZE PICKER	692149.0	1	1001852	4014486488869
12	FOR MAIZE PICKER	692150.0	1	1001857	4014486488920
15	FROM 6.0 M CUTTING TABLE	671013.1	1	1000676	4014486470482
15	FOR SOJA CUTTING TABLE	644209.0	1	1000699	4014486470826
19	KNIFE TO 5.7 M CUTTING TABLE	629214.1	1	1002317	4014486480054
20	TABLE (FROM NR. 14400125)	603017.3	2	1000833	4014486472592
22	SIEVE PAN DRIVE	609762.0	1	1001713	4014486486919
24		640653.1	1	1000350	4014486466065
25		644014.1	1	1002319	4014486480078
26	ROLLER	644015.1	1	1002913	4014486484601
27	ROLLER	644016.1	1	1001800	4014486488104
28	INTERMEDIATE SHAFT	064168.2	1	1003635	4014486488753
31	SCREEN (TO NR. 14400299)	233843.1	1	1000237	4014486463408
31	SCREEN (FROM NR. 14400300)	644267.0	1	1000243	4014486463613
32	FROM NR. 14400300	633030.2	1	1000220	4014486462838
35	FOR MAIZE	061872.0	2	1002867	4014486471939

CLAAS DOMINATOR 116, 118

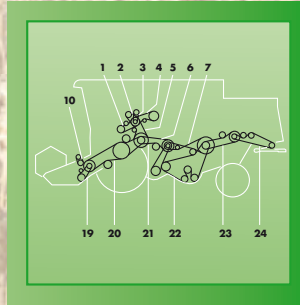
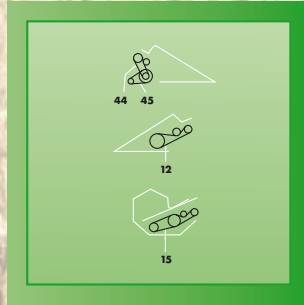
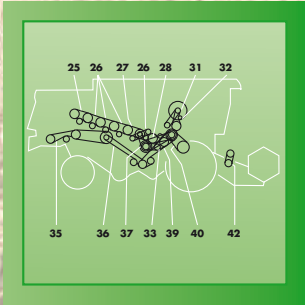

No.	Application	OEM - PN	Set	Optibelt AP-Nr.	EAN
36	FOR STRAW CHOPPER	061700.0	1	1003356	4014486486131
37	STRAW WALKER DRIVE	603247.1	1	1003626	4014486488111
38	FOR STRAW CHOPPER	061700.0	1	1003356	4014486486131
39		644014.1	1	1002319	4014486480078
40	CYLINDER N=500-1400 RPM	644177.0	1	1001221	4014486497762
40	CYLINDER N=650-1500 RPM	603015.1	1	1001503	4014486460186
44		680334.1	1	1001819	4014486488364
1	AT MERCEDES OM 441 A	661092.1	1	1001238	4014486491920
1	AT MERCEDES OM 421	629279.0	1	1001936	4014486490336
2	AT MERCEDES OM 441 A	633030.2	1	1000220	4014486462838
2	HYDRAULIC PUMP AT MERCEDES OM 366 LA	767057.1	1	1003333	4014486462609
2	HYDRAULIC PUMP 163 KW 4 GROOVE	767057.1	1	1003333	4014486462609
2		689175.0	1	1003391	4014486462654
3		629908.1	1	1002332	4014486478631
3	AT MERCEDES OM 441 A	661114.0	1	1002336	4014486478686
4	AT MERCEDES OM 366 LA WITH HYDRAULIC GROUND DRIVE	660409.0	1	1001575	4014486484809
4	AT MERCEDES OM 441 A	661093.0	1	1001581	4014486484885
4	AT MERCEDES OM 366 LA WITH MECHANICAL GROUND DRIVE	629769.1	1	1002699	4014486484922
4	AT PERKINS V8 540	629769.1	1	1002699	4014486484922
4	AT MERCEDES OM 421	629763.0	1	1003593	4014486484977
4	AT RABA - MOTOR	629763.0	1	1003593	4014486484977

CLAAS DOMINATOR 118



BISO - Schrattecker
BIZON
CASE INTL. HARVESTER
CLAAS
DEUTZ-FAHR
DRONNING-BORG
FENDT
FORTSCHRITT
JOHN DEERE
KRONE
LAVERDA
MASSEY FERGUSON
ROSTSELMASH
NEW HOLLAND

5	AT 5 - RILL DRIVE FROM 09403058	644403.0	1	1001247	4014486492033
5	AT 4 - RILL DRIVE FROM NO. 09403058	644404.1	1	1003354	4014486490763
5	TO NO. 094030057	629000.1	1	1003661	4014486490657
6		603337.0	1	1000662	4014486470260
7		603336.1	1	1000478	4014486467499
8	TO NO. 09404032	629732.2	1	1000417	4014486520507
8	FROM NO. 09404033	644447.0	1	1000420	4014486466836
9	NOT AT SERIES MAXI	640653.1	1	1000350	4014486466065
12	AT 3.9 M - 5.1 M	670224.1	1	1001158	4014486497380
14	FOR CORN PICKER	692149.0	1	1001852	4014486488869
14	FOR CORN PICKER	692150.0	1	1001857	4014486488920
17	AT 6.0 M - 9M	671013.1	1	1000676	4014486470482
19	AT 3.9 M - 5.1 M	713506.2	1	1000315	4014486465310
21	TO NO. 09404032	603017.3	2	1000833	4014486472592
22		603380.1	1	1001080	4014486498240
23		609762.0	1	1001713	4014486486919
24		506671.2	1	1000506	4014486467840
25		623427.1	1	1000409	4014486466720
30	AT MERCEDES - MOTOR FROM 09400751 - 09403057	783430.1	1	1000238	4014486463422
30	ROTARY SCREEN AT MERCEDES - MOTOR TO NO. 09400750	603341.0	1	1003328	4014486463217
32	TO NO. 09405334	821734.2	1	1000154	4014486461763
32	FROM NO. 09405335	661345.0	1	1000160	4014486461824

CLAAS DOMINATOR 118



No.	Application	OEM - PN	Set	Optibelt AP-Nr.	EAN
32	AT RABA - MOTOR	783876.0	1	1002091	4014486475845
33	AT 6.0 M - 9M	670224.1	1	1001158	4014486497380
35	AT RABA - MOTOR	629764.0	1	1000097	4014486460964
35	AT OM 366 LA 132 KW	657793.0	1	1000107	4014486461114
35	AT OM 366 LA 163 KW	661244.0	1	1000125	4014486461374
35	AT MERCEDES OM 441 A	661245.0	1	1003377	4014486461435
36	FOR CORN - CHOPPER	061214.0	1	1000868	4014486473070
36	FOR GRAIN CHOPPER FROM NO. 09403058	061353.1	1	1000870	4014486473094
36	FOR GRAIN CHOPPER TO NO. 09403057	061360.0	1	1000870	4014486473094
37	FROM NO. 09403058	609823.0	1	1001225	4014486497809
37	TO NO. 09403057	629035.0	1	1001289	4014486520545
38	VAR. 7818 2 GROOVE	661298.0	1	1001630	4014486485738
38	AT N 650 - 1500 MIN-1 TO 09403057	603354.0	1	1001844	4014486488739
38	VAR. 7693 / VAR. 7716 3 GROOVE	661220.1	1	1003340	4014486488807
38	AT N 510 - 1220 MIN-1 TO 09403057	629510.1	1	1003634	4014486488623
42	FOR HPH - G CHOPPER	680334.1	1	1001819	4014486488364
43	FOR SUCTION BLOWER	644448.0	1	1000139	4014486461565

CLAAS DOMINATOR 118 HYDR

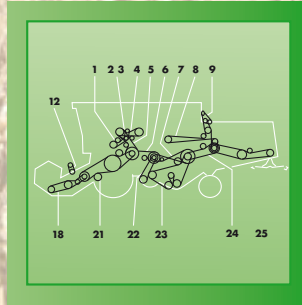
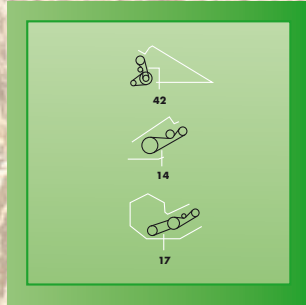
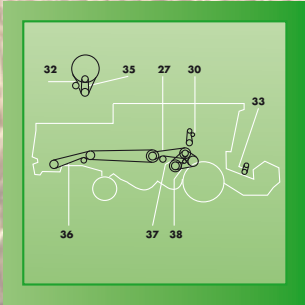

No.	Application	OEM - PN	Set	Optibelt AP-Nr.	EAN
1	FOR MERCEDES ENGINE OM 441 A	661092.1	1	1001238	4014486491920
1	FOR MERCEDES ENGINE OM 421	629279.0	1	1001936	4014486490336
1	FOR MERCEDES ENGINE OM 366 LA	644405.1	1	1001941	4014486490411
2		689175.0	1	1003391	4014486462654
3	FOR VAR. 7705	661114.0	1	1002336	4014486478686
4	FOR VAR. 7605	660409.0	1	1001575	4014486484809
4	FOR VAR. 7705	661093.0	1	1001581	4014486484885
4	TO NR. 09403057	629763.0	1	1003593	4014486484977
5	FROM NR. 09403058	644404.1	1	1003354	4014486490763
6		603337.0	1	1000662	4014486470260
8	TO NR. 09404032	629732.0	1	1000415	4014486466782
8	FROM NR. 09404033	644447.0	1	1000420	4014486466836
14	FOR MAIZE PICKER	692149.0	1	1001852	4014486488869
14	FOR MAIZE PICKER	692150.0	1	1001857	4014486488920
17	FOR 6.0 M - 9.0 M	671013.0	1	1000674	4014486470468
19	STRAW WALKER DRIVE	713506.0	1	1000315	4014486465310
21	SHAFT 1463 MM (TO NR. 09404032)	603017.0	2	1000833	4014486472592
23		609762.0	1	1001713	4014486486919
25		623427.0	1	1000410	4014486466737
30		783430.1	1	1000238	4014486463422
30		603341.0	1	1003328	4014486463217
32	TO NR. 09405334	821734.2	1	1000154	4014486461763

CLAAS DOMINATOR 118 HYDR

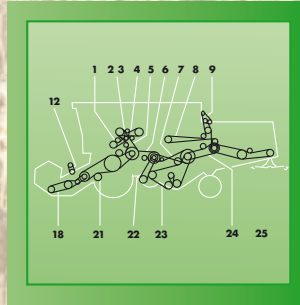
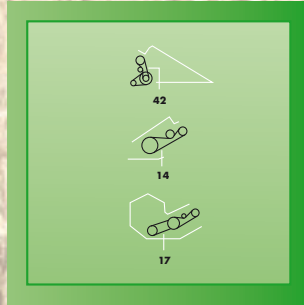
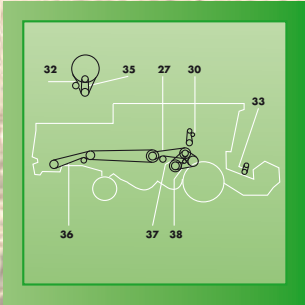

No.	Application	OEM - PN	Set	Optibelt AP-Nr.	EAN
32	FROM NR. 09405335	661345.0	1	1000160	4014486461824
32	FOR RABA - ENGINE	783876.0	1	1002091	4014486475845
35	FOR RABA - ENGINE	629764.0	1	1000097	4014486460964
35	FOR OM 366 LA	657793.0	1	1000107	4014486461114
35	FOR OM 366 LA	661244.0	1	1000125	4014486461374
35	FOR MERCEDES ENGINE OM 441 A	661245.0	1	1003377	4014486461435
36	CHOPPER DRIVE (MAIZE)	061214.0	1	1000868	4014486473070
36	CHOPPER DRIVE (GRAIN) (TO NR. 09403057)	061360.0	1	1000870	4014486473094
37	FROM NR. 09403058	609823.0	1	1001225	4014486497809
37	TO NR. 09403057	629035.0	1	1001289	4014486520545
38	VAR. 7818	661298.0	1	1001630	4014486485738
38	FOR N=650-1500 RPM	603354.0	1	1001844	4014486488739
38	FOR N=510-1220 RPM	629510.1	1	1003634	4014486488623
43	FOR AIR EXHAUST	644448.0	1	1000139	4014486461565

CLAAS DOMINATOR 118 MECH



No.	Application	OEM - PN	Set	Optibelt AP-Nr.	EAN
1		689175.0	1	1003391	4014486462654
5		603337.0	1	1000662	4014486470260
7	ELEVATOR DRIVE UNIT	629732.0	1	1000415	4014486466782
7	FROM NR. 09404033	644447.0	1	1000420	4014486466836
13	FOR MAIZE PICKER	692149.0	1	1001852	4014486488869
13	FOR MAIZE PICKER	692150.0	1	1001857	4014486488920
16	FOR 6.0 M - 9.0 M	671013.0	1	1000674	4014486470468
18	FOR 3.9 M - 5.1 M	713506.0	1	1000315	4014486465310
20	SHAFT BASE 1177 MM	629836.0	1	1000746	4014486471427
20	SHAFT 1306 MM	603290.0	2	1002869	4014486471663
22		609822.0	1	1001854	4014486488890
23		609823.0	1	1001225	4014486497809
25		609762.0	1	1001713	4014486486919
27		623427.0	1	1000410	4014486466737
32	FROM NR. 09400751	783430.1	1	1000238	4014486463422
32	TO NR. 09400750	603341.0	1	1003328	4014486463217
36	CHOPPER DRIVE (MAIZE)	061214.0	1	1000868	4014486473070
36	CHOPPER DRIVE (GRAIN) (TO NR. 09403057)	061360.0	1	1000870	4014486473094
37		628630.0	1	1001208	4014486497670

CLAAS DOMINATOR 128 VX

No.	Application	OEM - PN	Set	Optibelt AP-Nr.	EAN
1		544049.1	2	1001561	4014486484618
2	MERCEDES OM 366 LA	767057.1	1	1003333	4014486462609
2	MERCEDES OM 906 LA	656028.0	1	1003335	4014486462869
3	MERCEDES OM 906 LA	621903.1	1	1002041	4014486475166
3	MERCEDES OM 366 LA	629908.1	1	1002332	4014486478631
4		660409.0	1	1001575	4014486484809
5	MERCEDES OM 906 LA	544083.0	1	1001968	4014486490794
5	MERCEDES OM 366 LA	644404.1	1	1003354	4014486490763
6		603337.0	1	1000662	4014486470260
7		644141.1	1	1000476	4014486467475
8		644447.0	1	1000420	4014486466836
9		623427.1	1	1000409	4014486466720
11	N = 660	785341.0	1	1000295	4014486464870
11	N = 519	066034.0	1	1000302	4014486465037
13	FOR CORN	061214.0	1	1000868	4014486473070
13	TO NO. 09408296	061353.1	1	1000870	4014486473094
13	FROM NO. 09408297	644539.0	1	1000871	4014486473100
14		603380.1	1	1001080	4014486498240
15		609762.0	1	1001713	4014486486919
17	FROM NO. 09408297	644538.0	1	1001655	4014486486094
19		506671.2	1	1000506	4014486467840
20	MERCEDES OM 366 LA	661345.0	1	1000160	4014486461824

CLAAS DOMINATOR 128 VX, 130



20	MERCEDES OM 906 LA	545689.0	1	1003332	4014486461886
21	MERCEDES OM 366 LA	661244.0	1	1000125	4014486461374
22	TO NO. 09408296	644448.0	1	1000139	4014486461565
22	FROM NO. 09408297	644537.0	1	1000140	4014486461572
23	TWO STAGE DRIVE	609823.0	1	1001225	4014486497809
24	DRUM VARIABLE SPEED DRIVE N = 250 - 1250	661298.0	1	1001630	4014486485738
24	DRUM VARIABLE SPEED DRIVE N = 650 - 1500	661220.1	1	1003340	4014486488807
1	THRESHING MECHANISM DRIVE	628888.0	1	1001684	4014486486551
2	SIEVE PAN DRIVE	724141.0	1	1000709	4014486470970
3	DISCHARGE DRIVE GRAIN TANK	672351.0	1	1001570	4014486484731
5	AIR CONDITIONING COMPRESSOR DRIVE	349065.0	1	1002050	4014486475265
6	INTENSIVE SEPARATION SYSTEM DRIVE	802931.0	1	1003456	4014486465945
7	CUTTERBAR DRIVE	603290.0	2	1002869	4014486471663
8	CHOPPER DRIVE	061902.0	1	1000851	4014486472813
9	CUTTERBAR DRIVE	673638.1	1	1001099	4014486496819
10	FAN DRIVE VARIABLE SPEED	603380.1	1	1001080	4014486498240
11	SIEVE PAN DRIVE	724247.1	1	1000849	4014486472783
12	CHOPPER DRIVE	061872.0	2	1002867	4014486471939
14	STRAW WALKER DRIVE	785176.0	1	1000389	4014486466522
16	DRUM DRIVE VARIABLE SPEED (N=650-1500 RPM)	661430.0	1	1001229	4014486497830
16	DRUM DRIVE VARIABLE SPEED (N=500-1400 RPM)	661430.0	1	1001229	4014486497830

CLAAS DOMINATOR 140



No.	Application	OEM - PN	Set	Optibelt AP-Nr.	EAN
1	THRESHING MECHANISM DRIVE	628888.0	1	1001684	4014486486551
2	SIEVE PAN DRIVE	724141.0	1	1000709	4014486470970
3	DISCHARGE DRIVE GRAIN TANK	672351.0	1	1001570	4014486484731
5	AIR CONDITIONING COMPRESSOR DRIVE	349065.0	1	1002050	4014486475265
6	INTENSIVE SEPARATION SYSTEM DRIVE	802931.0	1	1003456	4014486465945
7	CUTTERBAR DRIVE	603290.0	2	1002869	4014486471663
8	CHOPPER DRIVE	061902.0	1	1000851	4014486472813
9	CUTTERBAR DRIVE	673638.1	1	1001099	4014486496819
10	FAN DRIVE VARIABLE SPEED	603380.1	1	1001080	4014486498240
11	SIEVE PAN DRIVE	724247.1	1	1000849	4014486472783
12	CHOPPER DRIVE	061872.0	2	1002867	4014486471939
14	STRAW WALKER DRIVE	785176.0	1	1000389	4014486466522
16	DRUM DRIVE VARIABLE SPEED (N=650-1500 RPM)	661430.0	1	1001229	4014486497830
16	DRUM DRIVE VARIABLE SPEED (N=500-1400 RPM)	661430.0	1	1001229	4014486497830

CLAAS DOMINATOR 150



No.	Application	OEM - PN	Set	Optibelt AP-Nr.	EAN
1	THRESHING MECHANISM DRIVE	628888.0	1	1001684	4014486486551
2	SIEVE PAN DRIVE	724141.0	1	1000709	4014486470970
3	DISCHARGE DRIVE GRAIN TANK	672351.0	1	1001570	4014486484731
5	AIR CONDITIONING COMPRESSOR DRIVE	349065.0	1	1002050	4014486475265
6	INTENSIVE SEPARATION SYSTEM DRIVE	802931.0	1	1003456	4014486465945
7	CUTTERBAR DRIVE	603290.0	2	1002869	4014486471663
8	CHOPPER DRIVE	061902.0	1	1000851	4014486472813
9	CUTTERBAR DRIVE	673638.1	1	1001099	4014486496819
10	FAN DRIVE VARIABLE SPEED	603380.1	1	1001080	4014486498240
11	SIEVE PAN DRIVE	724247.1	1	1000849	4014486472783
12	CHOPPER DRIVE	061872.0	2	1002867	4014486471939
14	STRAW WALKER DRIVE	785176.0	1	1000389	4014486466522
16	DRUM DRIVE VARIABLE SPEED (N=650-1500 RPM)	661430.0	1	1001229	4014486497830
16	DRUM DRIVE VARIABLE SPEED (N=500-1400 RPM)	661430.0	1	1001229	4014486497830

CLAAS DOMINATOR 203 MEGA

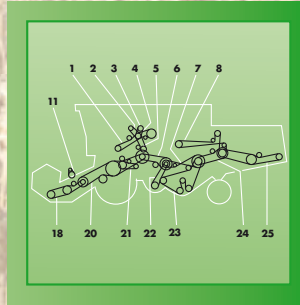
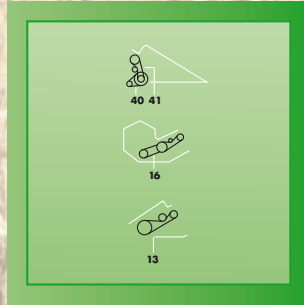
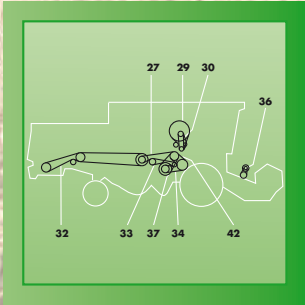

No.	Application	OEM - PN	Set	Optibelt AP-Nr.	EAN
	FOR TWO-STAGE DRIVE	609823.0	1	1001225	4014486497809
1	TRAVEL DRIVE	661362.1	1	1001951	4014486490565
2	HYDRAULIC PUMP DRIVE	767057.1	1	1003333	4014486462609
3	AIR CONDITIONING COMPRESSOR DRIVE	629908.1	1	1002332	4014486478631
5	THRESHING MACHINE	661458.0	1	1001957	4014486490640
6	COUNTERSHAFT DRIVE	603337.0	1	1000662	4014486470260
7	FOR DOMINATOR 203 MEGA	603336.1	1	1000478	4014486467499
11	REEL DRIVE BY 3.9 M - 5.1 M CUTTING TABLE	670224.1	1	1001158	4014486497380
13	FOR MAIZE PICKER	692149.0	1	1001852	4014486488869
13	FOR MAIZE PICKER	692150.0	1	1001857	4014486488920
13	FOR MULTIMASTER	629142.0	1	1001954	4014486490596
16	FOR 6.0 - 7.5 M CUTTING TABLE	671013.1	1	1000676	4014486470482
18	KNIFE DRIVE 3.9 - 5.1 M CUTTING TABLE	713506.2	1	1000315	4014486465310
22	BLOWER - DOMINATOR 203 MEGA	671209.0	1	1001039	4014486496383
23	SHAKER SHOE - 203 MEGA	603017.3	2	1000833	4014486472592
24	STRAW WALKER DRIVE	506671.2	1	1000506	4014486467840
25	STRAW DISTRIBUTOR	623427.1	1	1000409	4014486466720
27	STRAW CHOPPER DRIVE	060306.2	1	1000723	4014486471151
29	COOLER	661345.0	1	1000160	4014486461824
30	COUNTERSHAFT DRIVE	657793.0	1	1000107	4014486461114
32	STRAW CHOPPER (MAIZE)	061214.0	1	1000868	4014486473070
32	STRAW CHOPPER (GRAIN)	061360.0	1	1000870	4014486473094

CLAAS DOMINATOR 203 MEGA, 204 MEGA

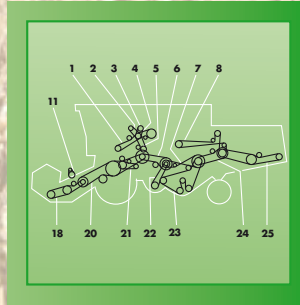
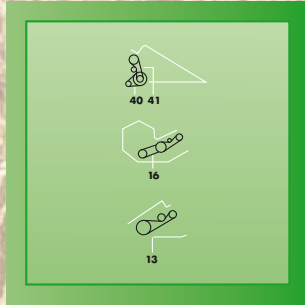
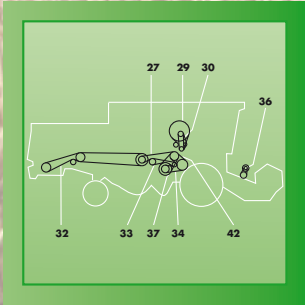

35	REEL DRIVE BY 6.0 M - 7.5 M CUTTING TABLE	670224.1	1	1001158	4014486497380
37	AIR EXHAUST	644448.0	1	1000139	4014486461565
41	CHOPPER DRIVE	680334.1	1	1001819	4014486488364
	FOR TWO-STAGE DRIVE	609823.0	1	1001225	4014486497809
1	TRAVEL DRIVE	661362.1	1	1001951	4014486490565
2	HYDRAULIC PUMP DRIVE	767057.1	1	1003333	4014486462609
3	AIR CONDITIONING COMPRESSOR DRIVE	629908.1	1	1002332	4014486478631
5	THRESHING MACHINE	661458.0	1	1001957	4014486490640
6	COUNTERSHAFT DRIVE	603337.0	1	1000662	4014486470260
7	FOR DOMINATOR 204 MEGA	644141.1	1	1000476	4014486467475
11	REEL DRIVE BY 3.9 M - 5.1 M CUTTING TABLE	670224.1	1	1001158	4014486497380
13	FOR MAIZE PICKER	692149.0	1	1001852	4014486488869
13	FOR MAIZE PICKER	692150.0	1	1001857	4014486488920
13	FOR MULTIMASTER	629142.0	1	1001954	4014486490596
16	FOR 6.0 - 7.5 M CUTTING TABLE	671013.1	1	1000676	4014486470482
18	KNIFE DRIVE 3.9 - 5.1 M CUTTING TABLE	713506.2	1	1000315	4014486465310
22	BLOWER - DOMINATOR 204 MEGA	603380.1	1	1001080	4014486498240
23	SHAKER SHOE - DOMINATOR 204 MEGA	609762.0	1	1001713	4014486486919
24	STRAW WALKER DRIVE	506671.2	1	1000506	4014486467840
25	STRAW DISTRIBUTOR	623427.1	1	1000409	4014486466720
27	STRAW CHOPPER DRIVE	060306.2	1	1000723	4014486471151

CLAAS DOMINATOR 204 MEGA, 208 MEGA

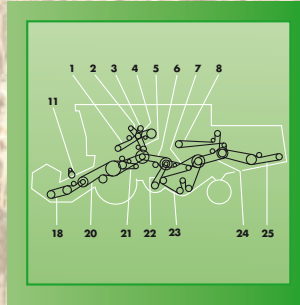
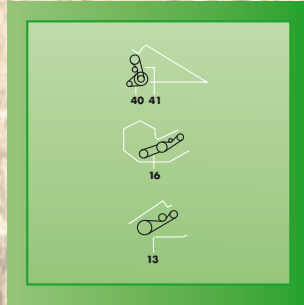
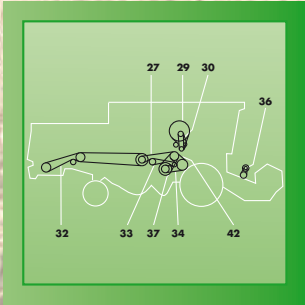

No.	Application	OEM - PN	Set	Optibelt AP-Nr.	EAN
29	COOLER	661345.0	1	1000160	4014486461824
30	COUNTERSHAFT DRIVE	657793.0	1	1000107	4014486461114
32	STRAW CHOPPER (MAIZE)	061214.0	1	1000868	4014486473070
32	STRAW CHOPPER (GRAIN)	061360.0	1	1000870	4014486473094
33	DOMINATOR 204 MEGA N=650-1500 RPM	609823.0	1	1001225	4014486497809
35	REEL DRIVE BY 6.0 M - 7.5 M CUTTING TABLE	670224.1	1	1001158	4014486497380
37	AIR EXHAUST	644448.0	1	1000139	4014486461565
41	CHOPPER DRIVE	680334.1	1	1001819	4014486488364
1	TRAVEL DRIVE - OM 366 LA	661451.0	1	1001958	4014486490664
2	HYDRAULIC PUMP DRIVE (OM 441 A)	633030.2	1	1000220	4014486462838
2	HYDRAULIC PUMP DRIVE (OM 366)	767057.1	1	1003333	4014486462609
3	AIR CONDITIONING COMPRESSOR DRIVE - OM 366 LA	629908.1	1	1002332	4014486478631
3	AIR CONDITIONING COMPRESSOR DRIVE - OM 441 A	661114.0	1	1002336	4014486478686
4	TANK UNLOADING - OM 366 LA	660409.0	1	1001575	4014486484809
4	TANK UNLOADING - OM 441 A	661093.0	1	1001581	4014486484885
5	THRESHING MACHINE - OM 441 A	644403.0	1	1001247	4014486492033
5	THRESHING MACHINE - OM 366 LA	644404.1	1	1003354	4014486490763
6	COUNTERSHAFT DRIVE	603337.0	1	1000662	4014486470260
7		644141.1	1	1000476	4014486467475
8		644447.0	1	1000420	4014486466836
11	REEL DRIVE BY 4.5 M - 5.1 M	670224.1	1	1001158	4014486497380

CLAAS DOMINATOR 208 MEGA



13	FOR MULTIMASTER	692149.0	1	1001852	4014486488869
13	FOR MULTIMASTER	692150.0	1	1001857	4014486488920
13	FOR MULTIMASTER	629142.0	1	1001954	4014486490596
16	REEL DRIVE BY 6.0 M - 9.0 M	671013.1	1	1000676	4014486470482
18	REEL DRIVE BY 4.5 M - 5.1 M	713506.2	1	1000315	4014486465310
22	BLOWER DRIVE	603380.1	1	1001080	4014486498240
23	SHAKER SHOE DRIVE	609762.0	1	1001713	4014486486919
24	STRAW WALKER DRIVE	506671.2	1	1000506	4014486467840
25	STRAW DISTRIBUTOR	623427.1	1	1000409	4014486466720
27	STRAW CHOPPER DRIVE	060306.2	1	1000723	4014486471151
30	COOLER	661345.0	1	1000160	4014486461824
31	COUNTERSHAFT - OM 366 LA	661244.0	1	1000125	4014486461374
31	COUNTERSHAFT - OM 441 A	661245.0	1	1003377	4014486461435
33	STRAW CHOPPER (MAIZE)	061214.0	1	1000868	4014486473070
34	TROMMELVORGELEGE	609823.0	1	1001225	4014486497809
35	REEL DRIVE BY N=510-1400 RPM	661298.0	1	1001630	4014486485738
36	REEL DRIVE BY 6.0 M - 9.0 M	670224.1	1	1001158	4014486497380
41	CHOPPER DRIVE	680334.1	1	1001819	4014486488364
42	FOR AIR EXHAUST	644448.0	1	1000139	4014486461565

CLAAS DOMINATOR 218 MEGA

No.	Application	OEM - PN	Set	Optibelt AP-Nr.	EAN
1	TRAVEL DRIVE - OM 366 LA	661451.0	1	1001958	4014486490664
2	HYDRAULIC PUMP DRIVE (OM 441 A)	633030.2	1	1000220	4014486462838
2	HYDRAULIC PUMP DRIVE (OM 366)	767057.1	1	1003333	4014486462609
3	AIR CONDITIONING COMPRESSOR DRIVE - OM 366 LA	629908.1	1	1002332	4014486478631
3	AIR CONDITIONING COMPRESSOR DRIVE - OM 441 A	661114.0	1	1002336	4014486478686
4	TANK UNLOADING - OM 366 LA	660409.0	1	1001575	4014486484809
4	TANK UNLOADING - OM 441 A	661093.0	1	1001581	4014486484885
5	THRESHING MACHINE - OM 441 A	644403.0	1	1001247	4014486492033
5	THRESHING MACHINE - OM 366 LA	644404.1	1	1003354	4014486490763
6	COUNTERSHAFT DRIVE	603337.0	1	1000662	4014486470260
7		644141.1	1	1000476	4014486467475
8		644447.0	1	1000420	4014486466836
11	REEL DRIVE BY 4.5 M - 5.1 M	670224.1	1	1001158	4014486497380
13	FOR MULTIMASTER	692149.0	1	1001852	4014486488869
13	FOR MULTIMASTER	692150.0	1	1001857	4014486488920
13	FOR MULTIMASTER	629142.0	1	1001954	4014486490596
16	REEL DRIVE BY 6.0 M - 9.0 M	671013.1	1	1000676	4014486470482
18	REEL DRIVE BY 4.5 M - 5.1 M	713506.2	1	1000315	4014486465310
22	BLOWER DRIVE	603380.1	1	1001080	4014486498240
23	SHAKER SHOE DRIVE	609762.0	1	1001713	4014486486919
24	STRAW WALKER DRIVE	506671.2	1	1000506	4014486467840
25	STRAW DISTRIBUTOR	623427.1	1	1000409	4014486466720

CLAAS DOMINATOR 218 MEGA, 38



27	STRAW CHOPPER DRIVE	060306.2	1	1000723	4014486471151
30	COOLER	661345.0	1	1000160	4014486461824
31	COUNTERSHAFT - OM 366 LA	661244.0	1	1000125	4014486461374
31	COUNTERSHAFT - OM 441 A	661245.0	1	1003377	4014486461435
33	STRAW CHOPPER (MAIZE)	061214.0	1	1000868	4014486473070
34	TROMMELVORGELEGE	609823.0	1	1001225	4014486497809
35	REEL DRIVE BY N=510-1400 RPM	661298.0	1	1001630	4014486485738
36	REEL DRIVE BY 6.0 M - 9.0 M	670224.1	1	1001158	4014486497380
41	CHOPPER DRIVE	680334.1	1	1001819	4014486488364
42	FOR AIR EXHAUST	644448.0	1	1000139	4014486461565
3	TO NO. 15200469	785341.0	1	1000295	4014486464870
6	FROM CUTTERBAR 247185	670224.1	1	1001158	4014486497380
8	FANNING MILL	724141.0	1	1000709	4014486470970
9	FOR THRESHING MECHANISM	724101.0	1	1001682	4014486486537
10		724179.0	1	1003423	4014486463965
11	HYDRAULIC PUMP	767057.1	1	1003333	4014486462609
12	FOR GROUND DRIVE	724180.0	1	1003615	4014486486490
13	STRAW WALKER	785176.0	1	1000389	4014486466522
17	TO NO. 15200689	724168.0	1	1000624	4014486520262
17	FROM NO. 15200690	724339.0	1	1000630	4014486469813
18	TO NO. 15201319	629756.0	1	1001209	4014486497687

CLAAS DOMINATOR 38, 48



No.	Application	OEM - PN	Set	Optibelt AP-Nr.	EAN
18	FROM NO. 15201320	671083.0	1	1003588	4014486460292
19		724248.1	1	1000850	4014486472806
20		603380.1	1	1001080	4014486498240
21		061878.0	1	1000824	4014486472509
25	STRAW CHOPPER	061872.0	2	1002867	4014486471939
26		603247.1	1	1003626	4014486488111
3		778561.0	1	1001038	4014486496376
9		724141.0	1	1000709	4014486470970
10		724101.0	1	1001682	4014486486537
13		724180.0	1	1003615	4014486486490
14		785176.0	1	1000389	4014486466522
16		724168.0	1	1000624	4014486520262
17		629756.0	1	1001209	4014486497687
18		724248.0	1	1000848	4014486472776
24		061872.0	2	1002867	4014486471939

CLAAS DOMINATOR 48 SP



No.	Application	OEM - PN	Set	Optibelt AP-Nr.	EAN
3	TO CUTTERBAR 247184	778561.0	1	1001038	4014486496376
8	FROM CUTTERBAR 247185	670224.1	1	1001158	4014486497380
9	FANNING MILL	724141.0	1	1000709	4014486470970
10	FOR THRESHING MECHANISM	724100.0	1	1001907	4014486489699
11		673614.1	1	1001566	4014486484694
12	HYDRAULIC PUMP	767057.1	1	1003333	4014486462609
13	FROM CUTTERBAR 247185	783268.1	1	1002055	4014486475326
14	FROM NO. 15400642	724180.0	1	1003615	4014486486490
15	TO NO. 15400641	785176.0	1	1000389	4014486466522
16		802931.0	1	1003456	4014486465945
18		724168.0	1	1000624	4014486520262
18		724339.0	1	1000630	4014486469813
19		629756.0	1	1001209	4014486497687
20		724247.1	1	1000849	4014486472783
21		603380.1	1	1001080	4014486498240
22		061902.0	1	1000851	4014486472813
26	STRAW CHOPPER	061872.0	2	1002867	4014486471939
27	AT N 650 - 1500 MIN-1 FROM NO. 15400932	661429.0	1	1001212	4014486497717
27	AT N 500 - 1400 MIN-1	661430.0	1	1001229	4014486497830
27	AT N 650 - 1500 MIN-1 TO NO 15400931	603015.1	1	1001503	4014486460186
28	PERKINS 6.3544	147228.1	1	1002283	4014486479669
28	PERKINS 1006.6	147233.1	2	1002945	4014486495492

CLAAS DOMINATOR 56

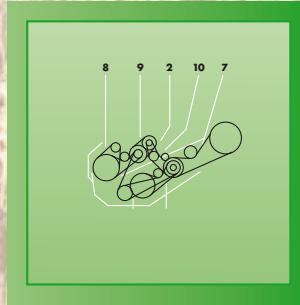
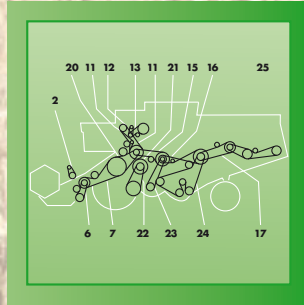
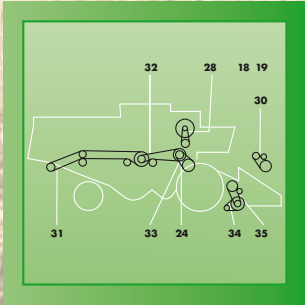

No.	Application	OEM - PN	Set	Optibelt AP-Nr.	EAN
7		629081.0	1	1000754	4014486471533
7		603122.0	1	1001116	4014486497007
8		603284.0	1	1000507	4014486467857
9		056961.0	1	1000117	4014486461268
10		056961.0	1	1000117	4014486461268
11	HYDRAULIC PUMP DRIVE	767057.1	1	1003333	4014486462609
15		603337.0	1	1000662	4014486470260
15		672358.0	1	1000662	4014486470260
18		603283.0	1	1000669	4014486470376
19		603048.0	1	1000503	4014486467789
20		673638.1	1	1001099	4014486496819
21		629436.0	1	1001630	4014486485738
22		629737.0	1	1001511	4014486460285
23		671209.0	1	1001039	4014486496383
24		603017.3	2	1000833	4014486472592
28		783430.1	1	1000238	4014486463422
31		061361.0	1	1000861	4014486472967
32	WHEEL SHAFT (FRONT)	060306.2	1	1000723	4014486471151
33		603015.1	1	1001503	4014486460186
35		680334.1	1	1001819	4014486488364

CLAAS DOMINATOR 58

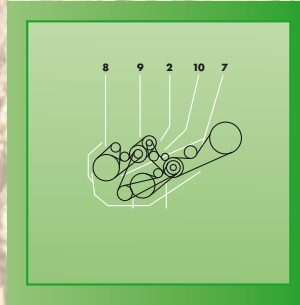
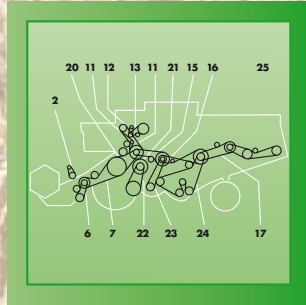
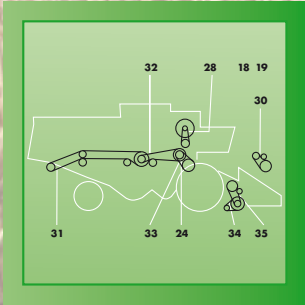

No.	Application	OEM - PN	Set	Optibelt AP-Nr.	EAN
1		778561.0	1	1001038	4014486496376
3		802931.0	1	1003456	4014486465945
4		785176.0	1	1000389	4014486466522
6		724181.0	1	1001679	4014486486483
7		724100.0	1	1001907	4014486489699
9		724141.0	1	1000709	4014486470970
10		061872.0	2	1002867	4014486471939
12		061902.0	1	1000851	4014486472813
15		629756.0	1	1001209	4014486497687
16		644177.0	1	1001221	4014486497762

CLAAS DOMINATOR 58 SP

No.	Application	OEM - PN	Set	Optibelt AP-Nr.	EAN
3	TO CUTTERBAR 247184	778561.0	1	1001038	4014486496376
8	FROM CUTTERBAR 247185	670224.1	1	1001158	4014486497380
9	FANNING MILL	724141.0	1	1000709	4014486470970
10	FOR THRESHING MECHANISM	724100.0	1	1001907	4014486489699
11		673614.1	1	1001566	4014486484694
12	HYDRAULIC PUMP	767057.1	1	1003333	4014486462609
13	FROM CUTTERBAR 247185	783268.1	1	1002055	4014486475326
14	FROM NO. 15400642	724180.0	1	1003615	4014486486490
15	TO NO. 15400641	785176.0	1	1000389	4014486466522
16		802931.0	1	1003456	4014486465945
18		724168.0	1	1000624	4014486520262
18		724339.0	1	1000630	4014486469813
19		629756.0	1	1001209	4014486497687
20		724247.1	1	1000849	4014486472783
21		603380.1	1	1001080	4014486498240
22		061902.0	1	1000851	4014486472813
26	STRAW CHOPPER	061872.0	2	1002867	4014486471939
27	AT N 650 - 1500 MIN-1 FROM NO. 15400932	661429.0	1	1001212	4014486497717
27	AT N 500 - 1400 MIN-1	661430.0	1	1001229	4014486497830
27	AT N 650 - 1500 MIN-1 TO NO 15400931	603015.1	1	1001503	4014486460186
28	PERKINS 6.3544	147228.1	1	1002283	4014486479669
28	PERKINS 1006.6	147233.1	2	1002945	4014486495492

CLAAS DOMINATOR 66

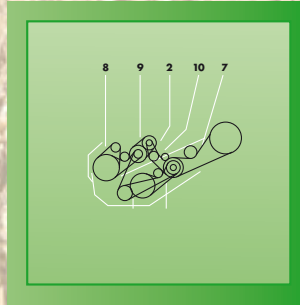
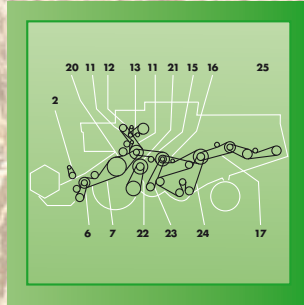
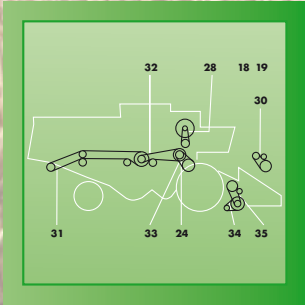

No.	Application	OEM - PN	Set	Optibelt AP-Nr.	EAN
7		629081.0	1	1000754	4014486471533
7		603122.0	1	1001116	4014486497007
8		603284.0	1	1000507	4014486467857
9		056961.0	1	1000117	4014486461268
10		056961.0	1	1000117	4014486461268
11	HYDRAULIC PUMP DRIVE	767057.1	1	1003333	4014486462609
15		603337.0	1	1000662	4014486470260
15		672358.0	1	1000662	4014486470260
18		603283.0	1	1000669	4014486470376
19		603048.0	1	1000503	4014486467789
20		673638.1	1	1001099	4014486496819
21		629436.0	1	1001630	4014486485738
22		629737.0	1	1001511	4014486460285
23		671209.0	1	1001039	4014486496383
24		603017.3	2	1000833	4014486472592
28		783430.1	1	1000238	4014486463422
31		061361.0	1	1000861	4014486472967
32	WHEEL SHAFT (FRONT)	060306.2	1	1000723	4014486471151
33		603015.1	1	1001503	4014486460186
35		680334.1	1	1001819	4014486488364

CLAAS DOMINATOR 68

No.	Application	OEM - PN	Set	Optibelt AP-Nr.	EAN
1	CUTTING MECHANICAL BY 3.0 M	603284.0	1	1000507	4014486467857
2	CUTTING MECHANICAL BY 3.0 M	056961.0	1	1000117	4014486461268
3		670224.1	1	1001158	4014486497380
4	CUTTING MECHANICAL BY 3.0 M	056961.0	1	1000117	4014486461268
5	FOR 3.6 M - 5.1 M TO CUTTING MECHANICAL 255807	713506.2	1	1000315	4014486465310
5	CUTTING MECHANICAL BY 3.6 M TO 5.1 M TO 25580	713506.2	1	1000315	4014486465310
5	CUTTING MECHANICAL BY 3.0 M TO CUT. 255806	603283.0	1	1000669	4014486470376
5	TO CUTTING MECHANICAL BY 3.0 TO CUT. 255807	778717.1	2	1002796	4014486465433
6	CUTTING MECHANICAL BY 3.0 M	603048.0	1	1000503	4014486467789
7	2X BY MAIZE PICKET (TO NR. 15606082)	629836.0	1	1000746	4014486471427
7	2X BY MAIZE PICKET (TO NR. 15606083)	603290.0	2	1002869	4014486471663
11		724100.0	1	1001907	4014486489699
12		724141.0	1	1000709	4014486470970
14		767057.1	1	1003333	4014486462609
15		724181.0	1	1001679	4014486486483
16		785176.0	1	1000389	4014486466522
17		802931.0	1	1003456	4014486465945
18	FOR STRAW DISTRIBUTOR	509435.0	1	1000403	4014486466669
20	CUTTING MECHANICAL TO 3.6 M	629214.1	1	1002317	4014486480054
21		673638.1	1	1001099	4014486496819
22		629756.0	1	1001209	4014486497687
23		603380.1	1	1001080	4014486498240

CLAAS DOMINATOR 68, 68 R



24		724247.1	1	1000849	4014486472783
27	FOR MAIZE	062043.0	1	1000843	4014486472721
27	FOR GRAIN	061902.0	1	1000851	4014486472813
28		061872.0	2	1002867	4014486471939
30	FOR N=650-1500 RPM (TO NR. 15603257)	628630.0	1	1001208	4014486497670
30	FOR N=500-1400 RPM	644177.0	1	1001221	4014486497762
30	FOR N=650-1550 RPM (TO NR. 15603256)	603015.1	1	1001503	4014486460186
32		680334.1	1	1001819	4014486488364
33	AIR CONDITIONING COMPRESSOR DRIVE	783268.1	1	1002055	4014486475326
3	REEK VARIATOR	670224.1	1	1001158	4014486497380
5	KNIFE DRIVE	713506.2	1	1000315	4014486465310
7	FEEDER DRIVE TO NO. 15500593 (2X FORN CORN)	629836.0	1	1000746	4014486471427
7	FEEDER HOUSING LONG	061872.0	2	1002867	4014486471939
7	FROM NO. 15500594 (2X FOR CORN)	603290.0	2	1002869	4014486471663
8		724100.0	1	1001907	4014486489699
9	FANNING MILL	724141.0	1	1000709	4014486470970
11	HYDRAULIC PUMP	767057.1	1	1003333	4014486462609
12	AIR CONDITIONER	783268.1	1	1002055	4014486475326
13		785176.0	1	1000389	4014486466522
14	FEED RAKE DRIVE	802931.0	1	1003456	4014486465945
15	STRAW SPREADER	509435.0	1	1000403	4014486466669

CLAAS DOMINATOR 68 R, 68 SR

No.	Application	OEM - PN	Set	Optibelt AP-Nr.	EAN
17	CUTTERBAR DRIVE	673638.1	1	1001099	4014486496819
18	DRIVE - VARIATOR	629756.0	1	1001209	4014486497687
19	BLOWER - VARIATOR	603380.1	1	1001080	4014486498240
20	SIEVE PAN DRIVE	724247.1	1	1000849	4014486472783
21	GROUND DRIVE	724181.0	1	1001679	4014486486483
22	AT CORN	062043.0	1	1000843	4014486472721
22	AT GRAIN	061902.0	1	1000851	4014486472813
23	STRAW CHOPPER	061872.0	2	1002867	4014486471939
27	AT N 650 - 1500 MIN-1	628630.0	1	1001208	4014486497670
27	AT N 500 - 1400 MIN-1	644177.0	1	1001221	4014486497762
27	AT N 650 - 1550 MIN-1	603015.1	1	1001503	4014486460186
29	FOR HPH - CHOPPER	680334.1	1	1001819	4014486488364
30	PERKINS 6.3544	147228.1	1	1002283	4014486479669
30	MERCEDES OM 352	133523.0	1	1002551	4014486494846
30	PERKINS 1006.6	147233.1	2	1002945	4014486495492
3	REEK VARIATOR	670224.1	1	1001158	4014486497380
5	KNIFE DRIVE	713506.2	1	1000315	4014486465310
7	FEEDER DRIVE TO NO. 15500593 (2X FORN CORN)	629836.0	1	1000746	4014486471427
7	FEEDER HOUSING LONG	061872.0	2	1002867	4014486471939
7	FROM NO. 15500594 (2X FOR CORN)	603290.0	2	1002869	4014486471663
8		724100.0	1	1001907	4014486489699

CLAAS DOMINATOR 68 SR



9	FANNING MILL	724141.0	1	1000709	4014486470970
11	HYDRAULIC PUMP	767057.1	1	1003333	4014486462609
12	AIR CONDITIONER	783268.1	1	1002055	4014486475326
13		785176.0	1	1000389	4014486466522
14	FEED RAKE DRIVE	802931.0	1	1003456	4014486465945
15	STRAW SPREADER	509435.0	1	1000403	4014486466669
17	CUTTERBAR DRIVE	673638.1	1	1001099	4014486496819
18	DRIVE - VARIATOR	629756.0	1	1001209	4014486497687
19	BLOWER - VARIATOR	603380.1	1	1001080	4014486498240
20	SIEVE PAN DRIVE	724247.1	1	1000849	4014486472783
21	GROUND DRIVE	724181.0	1	1001679	4014486486483
22	AT CORN	062043.0	1	1000843	4014486472721
22	AT GRAIN	061902.0	1	1000851	4014486472813
23	STRAW CHOPPER	061872.0	2	1002867	4014486471939
27	AT N 650 - 1500 MIN-1	628630.0	1	1001208	4014486497670
27	AT N 500 - 1400 MIN-1	644177.0	1	1001221	4014486497762
27	AT N 650 - 1550 MIN-1	603015.1	1	1001503	4014486460186
29	FOR HPH - CHOPPER	680334.1	1	1001819	4014486488364
30	PERKINS 6.3544	147228.1	1	1002283	4014486479669
30	MERCEDES OM 352	133523.0	1	1002551	4014486494846
30	PERKINS 1006.6	147233.1	2	1002945	4014486495492

CLAAS DOMINATOR 76

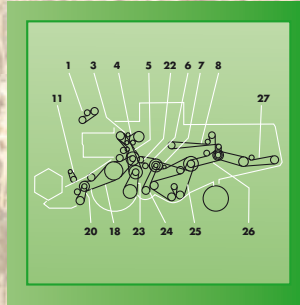
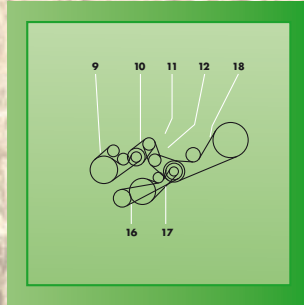
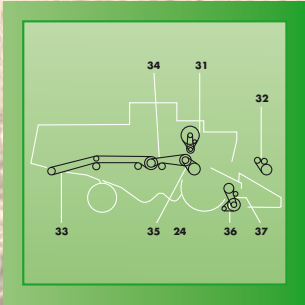

No.	Application	OEM - PN	Set	Optibelt AP-Nr.	EAN
1		673625.0	1	1001793	4014486488005
2	HYDRAULIC PUMP DRIVE	767057.1	1	1003333	4014486462609
6		603337.0	1	1000662	4014486470260
6	FAN DRIVE	672358.0	1	1000662	4014486470260
8	ELEVATOR DRIVE UNIT	629732.1	1	1000416	4014486466799
9		603284.0	1	1000507	4014486467857
10		056961.0	1	1000117	4014486461268
12		056961.0	1	1000117	4014486461268
16		603283.0	1	1000669	4014486470376
17		603048.0	1	1000503	4014486467789
18		603122.0	1	1001116	4014486497007
21		673638.1	1	1001099	4014486496819
22		629436.0	1	1001630	4014486485738
23		629737.0	1	1001511	4014486460285
24		671209.0	1	1001039	4014486496383
25		603017.3	2	1000833	4014486472592
27		623427.1	1	1000409	4014486466720
31		783430.1	1	1000238	4014486463422
33		061360.0	1	1000870	4014486473094
34		060306.2	1	1000723	4014486471151
35		603015.1	1	1001503	4014486460186
37		680334.1	1	1001819	4014486488364

CLAAS DOMINATOR 78



BISO - Schrottenecker
BIZON
CASE INTL. HARVESTER
CLAAS
DEUTZ-FAHR
DRONNING-BORG
FENDT
FORTSCHRITT
JOHN DEERE
KRONE
LAVERDA
MASSEY FERGUSON
ROSTSELMASH
NEW HOLLAND

No.	Application	OEM - PN	Set	Optibelt AP-Nr.	EAN
1	AT HYDRAULIC GROUND DRIVE	673625.0	1	1001793	4014486488005
2	HYDRAULIC PUMP	767057.1	1	1003333	4014486462609
3	AT AIR CONDITIONING	629908.1	1	1002332	4014486478631
4		673614.1	1	1001566	4014486484694
5		671012.1	1	1003631	4014486488500
6		603337.0	1	1000662	4014486470260
7		603336.1	1	1000478	4014486467499
8		629732.2	1	1000417	4014486520507
11	FOR CUTTERBAR	670224.1	1	1001158	4014486497380
13	FOR CORN PICKER	692149.0	1	1001852	4014486488869
13	FOR CORN PICKER	692150.0	1	1001857	4014486488920
16	FROM 3.6 M CUTTERBAR	713506.2	1	1000315	4014486465310
16	AT 3.0 M CUTTERBAR	778717.1	2	1002796	4014486465433
18	FEEDER DRIVE TO NO. 09101946 FOR CORN	629836.0	1	1000746	4014486471427
18	FEEDER DRIVE TO NO. 09101946 FOR CORN	629836.0	1	1000746	4014486471427
18	FROM NO. 09101947 FOR CORN	603290.0	2	1002869	4014486471663
18	FROM NO. 09101947 FOR CORN	603290.0	2	1002869	4014486471663
19		673638.1	1	1001099	4014486496819
20	AT MECHANICAL GROUND DRIVE	603427.0	1	1001627	4014486485660
21	AT MECHANICAL GROUND DRIVE	603317.0	1	1001515	4014486460346
22		671209.0	1	1001039	4014486496383
23	RETURNS AUGER	603017.3	2	1000833	4014486472592

CLAAS DOMINATOR 78, 80

No.	Application	OEM - PN	Set	Optibelt AP-Nr.	EAN
24		506671.2	1	1000506	4014486467840
25	FOR STRAW SPREADER	623427.1	1	1000409	4014486466720
29	ROTARY SCREEN	603341.0	1	1003328	4014486463217
31	FOR CORN CHOPPER	061214.0	1	1000868	4014486473070
31	FOR GRAIN - CHOPPER	061360.0	1	1000870	4014486473094
32	AT N 650 - 1500 MIN-1	628630.0	1	1001208	4014486497670
32	AT N 500 - 1400 MIN-1	644177.0	1	1001221	4014486497762
34	FOR HPG - G CHOPPER	680334.1	1	1001819	4014486488364
2	CUTTING TABLE DRIVE CLUTCH	560562.0	1	1001101	4014486496833
4	HYDRAULIC PUMP TRACTION DRIVE	673625.0	1	1001793	4014486488005
5	HYDRAULIC PUMP DRIVE	656028.0	1	1003335	4014486462869
7	SHAKER SHOE FANNING MILL	672358.0	1	1000662	4014486470260
8	STRAW WALKER DRIVE	673601.0	1	1000512	4014486467901
8	STRAW WALKER DRIVE	629036.0	1	1000515	4014486467949
10	CUTTING TABLE DRIVE	673639.0	1	1000963	4014486474213
11	TRACTION DRIVE	720866.0	1	1003607	4014486485721
12	TRACTION VARIATOR DRIVE	671083.0	1	1003588	4014486460292
13	FAN MILL VARIABLE SPEED	671209.0	1	1001039	4014486496383
15	AUGER (GRAIN)	673690.0	1	1000558	4014486468557
16	FEEDER AUGER	501925.0	1	1003449	4014486465501
18	AIR INTAKE DRIVE	802931.0	1	1003456	4014486465945

CLAAS DOMINATOR 80, 85



20	CYLINDER VARIATOR DRIVE	671015.0	1	1001287	4014486497854
20	CYLINDER VARIATOR DRIVE	629035.0	1	1001289	4014486520545
2	CUTTING TABLE DRIVE CLUTCH	560562.0	1	1001101	4014486496833
4	HYDRAULIC PUMP TRACTION DRIVE	673625.0	1	1001793	4014486488005
5	HYDRAULIC PUMP DRIVE	656028.0	1	1003335	4014486462869
7	SHAKER SHOE FANNING MILL	672358.0	1	1000662	4014486470260
8	STRAW WALKER DRIVE	673601.0	1	1000512	4014486467901
8	STRAW WALKER DRIVE	629036.0	1	1000515	4014486467949
10	CUTTING TABLE DRIVE	673639.0	1	1000963	4014486474213
11	TRACTION DRIVE	720866.0	1	1003607	4014486485721
12	TRACTION VARIATOR DRIVE	671083.0	1	1003588	4014486460292
13	FAN MILL VARIABLE SPEED	671209.0	1	1001039	4014486496383
15	AUGER (GRAIN)	673690.0	1	1000558	4014486468557
16	FEEDER AUGER	501925.0	1	1003449	4014486465501
18	AIR INTAKE DRIVE	802931.0	1	1003456	4014486465945
20	CYLINDER VARIATOR DRIVE	671015.0	1	1001287	4014486497854
20	CYLINDER VARIATOR DRIVE	629035.0	1	1001289	4014486520545

CLAAS DOMINATOR 86, 88

No.	Application	OEM - PN	Set	Optibelt AP-Nr.	EAN
5		603337.0	1	1000662	4014486470260
7	ELEVATOR DRIVE UNIT	629732.0	1	1000415	4014486466782
14		603122.0	1	1001116	4014486497007
16		603427.0	1	1001627	4014486485660
17		603317.0	1	1001515	4014486460346
18		671209.0	1	1001039	4014486496383
19		603017.0	2	1000833	4014486472592
24		603341.0	1	1003328	4014486463217
26		061361.0	1	1000861	4014486472967
1		673625.0	1	1001793	4014486488005
2	HYDRAULIC PUMP	767057.1	1	1003333	4014486462609
3		629908.1	1	1002332	4014486478631
4		673614.1	1	1001566	4014486484694
5		671012.1	1	1003631	4014486488500
6		603337.0	1	1000662	4014486470260
7		603336.1	1	1000478	4014486467499
8		629732.2	1	1000417	4014486520507
12	AT 3.6 M - 5.1 M	670224.1	1	1001158	4014486497380
14	FOR CORN PICKER	692149.0	1	1001852	4014486488869
14	FOR CORN PICKER	692150.0	1	1001857	4014486488920
17	AT 6.0 M - 6.6 M	671013.1	1	1000676	4014486470482

CLAAS DOMINATOR 88



19	AT 3.6 M - 5.1 M	713506.2	1	1000315	4014486465310
21	FEEDER DRIVE SHAFTS DISTANCE 1177 MM	629836.0	1	1000746	4014486471427
21	SHAFTS DISTANCE 1306 MM	603290.0	2	1002869	4014486471663
22		673638.1	1	1001099	4014486496819
23		609822.0	1	1001854	4014486488890
24		609823.0	1	1001225	4014486497809
25		671209.0	1	1001039	4014486496383
26		603017.3	2	1000833	4014486472592
27		506671.2	1	1000506	4014486467840
32	ROTARY SCREEN	603341.0	1	1003328	4014486463217
34	AT 6.0 M - 6.6 M	670224.1	1	1001158	4014486497380
36	FOR CORN - CHOPPER	061213.0	1	1000860	4014486472943
36	FOR GRAIN - CHOPPER	061361.0	1	1000861	4014486472967
37	AT N 650 - 1500 MIN-1	628630.0	1	1001208	4014486497670
37	AT N 500 - 1400 MIN-1	644177.0	1	1001221	4014486497762
37	AT VAR. 7715	609823.0	1	1001225	4014486497809
41	FOR HPH-G CHOPPER	680334.1	1	1001819	4014486488364
42	AT VAR. 7715	661220.1	1	1003340	4014486488807

CLAAS DOMINATOR 88 VX

No.	Application	OEM - PN	Set	Optibelt AP-Nr.	EAN
1		544048.0	1	1001933	4014486490299
2		767057.1	1	1003333	4014486462609
3		629908.1	1	1002332	4014486478631
4		629769.1	1	1002699	4014486484922
5		671012.1	1	1003631	4014486488500
6		603337.0	1	1000662	4014486470260
7		603336.1	1	1000478	4014486467499
8		644447.0	1	1000420	4014486466836
11	FOR CORN	061213.0	1	1000860	4014486472943
11		061361.0	1	1000861	4014486472967
12		671209.0	1	1001039	4014486496383
13		603017.3	2	1000833	4014486472592
17		506671.2	1	1000506	4014486467840
18		661345.0	1	1000160	4014486461824
19		657793.0	1	1000107	4014486461114
20		628630.0	1	1001208	4014486497670
21		644448.0	1	1000139	4014486461565
22		609823.0	1	1001225	4014486497809
23		661220.1	1	1003340	4014486488807

CLAAS DOMINATOR 96

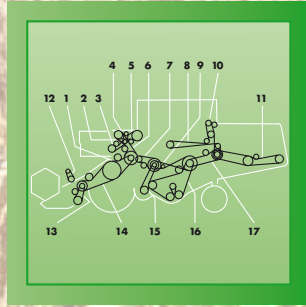
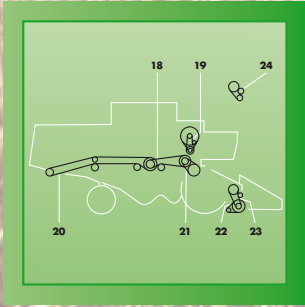

No.	Application	OEM - PN	Set	Optibelt AP-Nr.	EAN
2		767057.1	1	1003333	4014486462609
3		673625.0	1	1001793	4014486488005
7		603337.0	1	1000662	4014486470260
8		629732.1	1	1000416	4014486466799
10		802931.0	1	1003456	4014486465945
11		623427.1	1	1000409	4014486466720
14		603122.0	1	1001116	4014486497007
15		671209.0	1	1001039	4014486496383
16		603017.3	2	1000833	4014486472592
19		603341.0	1	1003328	4014486463217
20		061360.0	1	1000870	4014486473094
21		603015.1	1	1001503	4014486460186
23		680334.1	1	1001819	4014486488364

CLAAS DOMINATOR 98

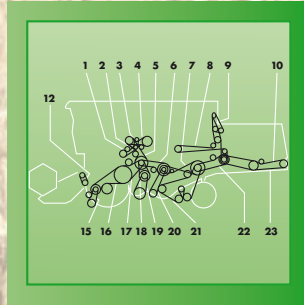
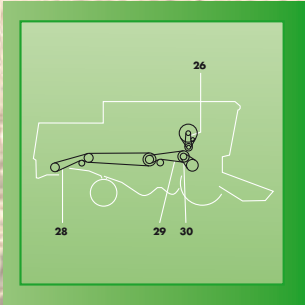

No.	Application	OEM - PN	Set	Optibelt AP-Nr.	EAN
1	MERCEDES ENGINE OM 360	673625.0	1	1001793	4014486488005
2	MERCEDES ENGINE OM 352A + PERKINS ENGINE T63544	603378.0	1	1003388	4014486462524
6		603337.0	1	1000662	4014486470260
8		629732.0	1	1000415	4014486466782
9		802931.0	1	1003456	4014486465945
15		713506.0	1	1000315	4014486465310
16	SHAFT BASE 1177 MM	629836.0	1	1000746	4014486471427
16	SHAFT BASE 1463 MM	061872.0	2	1002867	4014486471939
18	MECHANICAL DRIVE	609822.0	1	1001854	4014486488890
19	MECHANICAL DRIVE	609823.0	1	1001225	4014486497809
20		671209.0	1	1001039	4014486496383
21		603017.0	2	1000833	4014486472592
23		623427.0	1	1000410	4014486466737
26		603341.0	1	1003328	4014486463217
28	FOR MAIZE STRAW CHOPPER	061214.0	1	1000868	4014486473070
28	FOR STRAW CHOPPER	061360.0	1	1000870	4014486473094
30	CYLINDER N=650-1500 RPM	628630.0	1	1001208	4014486497670
30	CYLINDER N=500-1400 RPM	644177.0	1	1001221	4014486497762

CLAAS DOMINATOR 98 VX



BISO - Schrottenecker
BIZON
CASE INTL. HARVESTER
CLAAS
DEUTZ-FAHR
DRONNING-BORG
FENDT
FORTSCHRITT
JOHN DEERE
KRONE
LAVERDA
MASSEY FERGUSON
NEW HOLLAND
ROSTSELMASH

No.	Application	OEM - PN	Set	Optibelt AP-Nr.	EAN
1		544048.0	1	1001933	4014486490299
2		767057.1	1	1003333	4014486462609
3		629908.1	1	1002332	4014486478631
4		629769.1	1	1002699	4014486484922
5		661458.0	1	1001957	4014486490640
6		603337.0	1	1000662	4014486470260
7		603336.1	1	1000478	4014486467499
9		802931.0	1	1003456	4014486465945
10		623427.1	1	1000409	4014486466720
12		785341.0	1	1000295	4014486464870
12		066034.0	1	1000302	4014486465037
14		061214.0	1	1000868	4014486473070
15		671209.0	1	1001039	4014486496383
16		603017.3	2	1000833	4014486472592
20		506671.2	1	1000506	4014486467840
21		661345.0	1	1000160	4014486461824
22		657793.0	1	1000107	4014486461114
24		644448.0	1	1000139	4014486461565
25		609823.0	1	1001225	4014486497809
26		661220.1	1	1003340	4014486488807

CLAAS EUROPA

No.	Application	OEM - PN	Set	Optibelt AP-Nr.	EAN
1	BALER	506880.0	1	1000901	4014486473476
2	KNIFE DRIVE	756051.0	1	1003508	4014486469240
2	COUNTERSHAFT - STRAW CHOPPER	801221.0	1	1004103	4014486473315
3	TANK UNLOADER DRIVE	756059.0	1	1000889	4014486520286
3	TANK UNLOADER DRIVE	756051.0	1	1003508	4014486469240
4	RADIATOR FAN DRIVE	758719.0	1	1003405	4014486463309
6	SPREADER GRAIN IN TANK	775698.0	1	1000272	4014486464429
7	PICK UP DRIVE	800309.0	1	1003435	4014486464719
8	STRAW CHOPPER DRIVE	506940.0	1	1000934	4014486473858
11	TRACTION DRIVE	750316.0	1	1000454	4014486467239
11	TRACTION DRIVE	750284.0	1	1000891	4014486473339
13	TRACTION DRIVE	751112.0	1	1001161	4014486497427
14	SHAKER SHOE FANBALER	772658.0	1	1000935	4014486473865
14	SHAKER SHOE FANBALER	772659.0	1	1000937	4014486473889
15	STRAW WALKER ELEVATOR	773313.0	1	1000480	4014486467512
15	STRAW WALKER ELEVATOR	774100.0	1	1003481	4014486467963
16	COUNTERSHAFT - STRAW CHOPPER	801221.0	1	1004103	4014486473315
22	CHAFF SPREADER DRIVE (LOWER)	123306A1	1	1002307	4014486479959

CLAAS JAGUAR 60, 675



No.	Application	OEM - PN	Set	Optibelt AP-Nr.	EAN
2	ANGLE GEAR BOX N=540 RPM	943227.0	2	1003760	4014486462951
4	ANGLE GEAR BOX N=1000 RPM	211148.1	1	1002114	4014486476156
1	FEEDER DRIVE	629836.0	1	1000746	4014486471427
2		070310.1	1	1000380	4014486466430
4		070953.1	1	1002020	4014486491555
5		609823.0	1	1001225	4014486497809
6		644016.1	1	1001800	4014486488104
7	FOR HYDRAULIC PUMP	750193.2	1	1003399	4014486462937
8	FOR AIR CONDITIONING	659025.0	1	1000094	4014486460926
9	FOR CORN - CRACKER	072110.0	1	1001182	4014486490206
14	FOR ALTERNATOR AT OM 421	133528.0	1	1002560	4014486495102
15	COOLING AT OM 421	133630.1	2	1002961	4014486495058
15	COOLING AND ALTERNATOR AT OM 360	685693.0	2	1003773	4014486495065

CLAAS JAGUAR 675 HYDRO, 680



No.	Application	OEM - PN	Set	Optibelt AP-Nr.	EAN
1	FEEDER DRIVE	629836.0	1	1000746	4014486471427
2		070310.1	1	1000380	4014486466430
4		070953.1	1	1002020	4014486491555
5	FOR HYDRAULIC PUMP	750193.2	1	1003399	4014486462937
6	FOR AIR CONDITIONING	659025.0	1	1000094	4014486460926
7		176543.1	1	1001793	4014486488005
9	FOR CORN CRACKER	072110.0	1	1001182	4014486490206
13	FOR ALTERNATOR	133528.0	1	1002560	4014486495102
14	FOR COOLING	133630.1	2	1002961	4014486495058
1	FEEDER DRIVE	629836.0	1	1000746	4014486471427
2		070310.1	1	1000380	4014486466430
4		070953.1	1	1002020	4014486491555
5		609823.0	1	1001225	4014486497809
6		644016.1	1	1001800	4014486488104
7	FOR HYDRAULIC PUMP	750193.2	1	1003399	4014486462937
8	FOR AIR CONDITIONING	659025.0	1	1000094	4014486460926
9	FOR CORN CRACKER	072110.0	1	1001182	4014486490206
14	FOR ALTERNATOR AT OM 421	133528.0	1	1002560	4014486495102
15	COOLING AT OM 421	133630.1	2	1002961	4014486495058
15	COOLING AND ALTERNATOR AT OM 360	685693.0	2	1003773	4014486495065

CLAAS JAGUAR 680 HYDRO, 682



No.	Application	OEM - PN	Set	Optibelt AP-Nr.	EAN
1		629836.0	1	1000746	4014486471427
2		070310.1	1	1000380	4014486466430
4		070953.1	1	1002020	4014486491555
5	FOR HYDRAULIC PUMP	750193.2	1	1003399	4014486462937
6	FOR AIR CONDITIONING	659025.0	1	1000094	4014486460926
7		176543.1	1	1001793	4014486488005
9	FOR CORN CRACKER	072110.0	1	1001182	4014486490206
13	FOR ALTERNATOR	133528.0	1	1002560	4014486495102
14	FOR COOLING	133630.1	2	1002961	4014486495058
1	FOR ACCELERATOR	629732.2	1	1000417	4014486520507
2	FOR SLIP DRIVE	070310.1	1	1000380	4014486466430
3	FOR HYDRAULIC PUMP TO NO. 18600321	750294.0	1	1000251	4014486463897
7	FOR CORN CRACKER	629763.0	1	1003593	4014486484977
8	FOR CHOPPER DRUM	073202.1	1	1002012	4014486491425
9	AT MECHANICAL GROUND DRIVE	629756.0	1	1001209	4014486497687
9	AT HYDRAULIC GROUND DRIVE	073203.0	1	1001810	4014486488227
10	MOTOR - INTERMEDIATE DRIVE FROM NO. 18600322	073199.0	1	1002004	4014486491319
11	ALTERNATOR MERCEDES FROM NO. 18600322	133641.0	1	1002596	4014486496017
11	ALTERNATOR PERKINS TO NO. 18600321	602387.1	2	1002956	4014486495720
12	FOR CORN CRACKER	073204.0	1	1001183	4014486490213
13	AT 4G - CHAIN DRIVE	644015.1	1	1002913	4014486484601

CLAAS JAGUAR 682 SL, 682 S

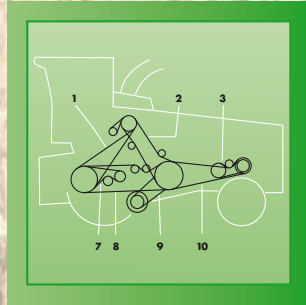
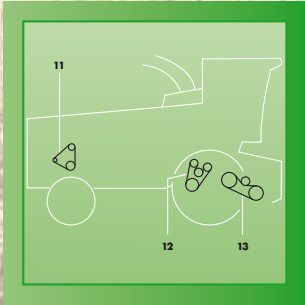

No.	Application	OEM - PN	Set	Optibelt AP-Nr.	EAN
1	DRUM DRIVE VARIABLE SPEED	629732.2	1	1000417	4014486520507
2	STRAW WALKER DRIVE	070310.1	1	1000380	4014486466430
3	HYDRAULIC PUMP DRIVE	750294.0	1	1000251	4014486463897
7	CORN CRACKER DRIVE	629763.0	1	1003593	4014486484977
9	MECHANICAL DRIVE	629756.0	1	1001209	4014486497687
9	HYDROSTATIC SPEED DRIVE	073203.0	1	1001810	4014486488227
10	ENGINE	073201.0	1	1002004	4014486491319
12	CORN CRACKER DRIVE	073204.0	1	1001183	4014486490213
13	FEEDER DRIVE	644015.1	1	1002913	4014486484601
1	DRUM DRIVE VARIABLE SPEED	629732.2	1	1000417	4014486520507
2	STRAW WALKER DRIVE	070310.1	1	1000380	4014486466430
3	HYDRAULIC PUMP DRIVE	750294.0	1	1000251	4014486463897
7	CORN CRACKER DRIVE	629763.0	1	1003593	4014486484977
9	MECHANICAL DRIVE	629756.0	1	1001209	4014486497687
9	HYDROSTATIC SPEED DRIVE	073203.0	1	1001810	4014486488227
10	ENGINE	073201.0	1	1002004	4014486491319
12	CORN CRACKER DRIVE	073204.0	1	1001183	4014486490213
13	FEEDER DRIVE	644015.1	1	1002913	4014486484601

CLAAS JAGUAR 685, 685 SL

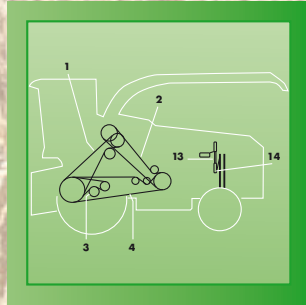
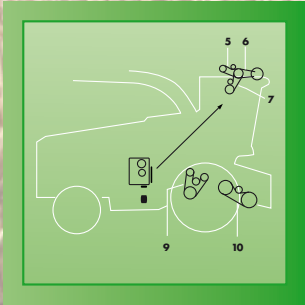

No.	Application	OEM - PN	Set	Optibelt AP-Nr.	EAN
1	DRUM DRIVE	629836.0	1	1000746	4014486471427
2	FEEDER DRIVE	070310.1	1	1000380	4014486466430
4	HEAD DRUM DRIVE	070952.2	1	1001264	4014486492293
5	HYDRAULIC PUMP DRIVE	750193.2	1	1003399	4014486462937
6	AIR CONDITIONING COMPRESSOR DRIVE	659025.0	1	1000094	4014486460926
7	HYDRAULIC SPEED DRIVE	673625.0	1	1001793	4014486488005
9	CORN - CRACKER DRIVE RIGHT	072110.0	1	1001182	4014486490206
13	ALTERNATOR DRIVE	133528.0	1	1002560	4014486495102
1	DRUM DRIVE	629836.0	1	1000746	4014486471427
2	FEEDER DRIVE	070310.1	1	1000380	4014486466430
3	ALTERNATOR DRIVE	133528.0	1	1002560	4014486495102
5	CORN CRACKER DRIVE	629763.0	1	1003593	4014486484977
6	FOR JAGUAR 690/685 SL	070952.2	1	1001264	4014486492293
7	HYDRAULIC PUMP DRIVE	750193.2	1	1003399	4014486462937
8	AIR CONDITIONING COMPRESSOR DRIVE	659025.0	1	1000094	4014486460926
10	CORN CRACKER DRIVE	073204.0	1	1001183	4014486490213

CLAAS JAGUAR 690, 690 SL

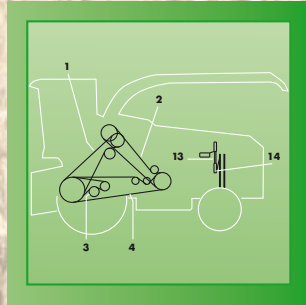
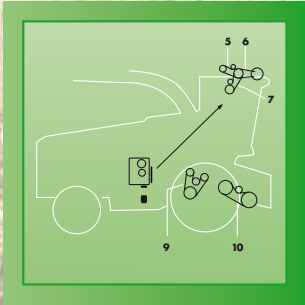

No.	Application	OEM - PN	Set	Optibelt AP-Nr.	EAN
1	DRUM DRIVE	629836.0	1	1000746	4014486471427
2	FEEDER DRIVE	070310.1	1	1000380	4014486466430
4	HEAD DRUM DRIVE	070952.2	1	1001264	4014486492293
5	HYDRAULIC PUMP DRIVE	750193.2	1	1003399	4014486462937
6	AIR CONDITIONING COMPRESSOR DRIVE	659025.0	1	1000094	4014486460926
7	HYDRAULIC SPEED DRIVE	673625.0	1	1001793	4014486488005
9	CORN - CRACKER DRIVE RIGHT	072110.0	1	1001182	4014486490206
13	ALTERNATOR DRIVE	133528.0	1	1002560	4014486495102
1	FOR ACCELERATOR	629836.0	1	1000746	4014486471427
2	FOR SLIP DRIVE	070310.1	1	1000380	4014486466430
3	FOR ALTERNATOR	133528.0	1	1002560	4014486495102
4	FOR MOTOR COOLING	133630.1	2	1002961	4014486495058
5	FOR CORN CRACKER	629763.0	1	1003593	4014486484977
6	AT JAGUAR 690 SL TO NO. 18800011	070952.2	1	1001264	4014486492293
6	AT JAGUAR 690 SL FROM NO. 18800012	074803.2	1	1001266	4014486492316
7	FOR HYDRAULIC PUMP	750193.2	1	1003399	4014486462937
8	FOR AIR CONDITIONING	659025.0	1	1000094	4014486460926
9	FOR GROUND DRIVE	176543.1	1	1001793	4014486488005
10	FOR CORN CRACKER	073204.0	1	1001183	4014486490213

CLAAS JAGUAR 695 SL, 70 SF, 71, 75

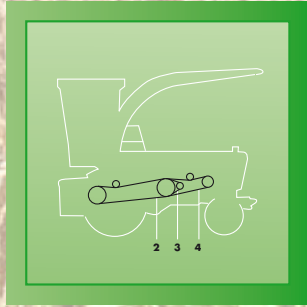
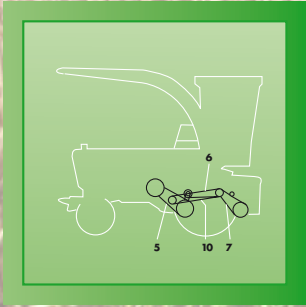

No.	Application	OEM - PN	Set	Optibelt AP-Nr.	EAN
1	DRUM DRIVE	629836.0	1	1000746	4014486471427
2	FEEDER DRIVE	070310.1	1	1000380	4014486466430
3	ALTERNATOR DRIVE	133528.0	1	1002560	4014486495102
5	CORN CRACKER DRIVE	629763.0	1	1003593	4014486484977
7	HYDRAULIC PUMP DRIVE	750193.2	1	1003399	4014486462937
8	AIR CONDITIONING COMPRESSOR DRIVE	659025.0	1	1000094	4014486460926
10	CORN CRACKER DRIVE	073204.0	1	1001183	4014486490213
2	DRUM DRIVE VARIABLE SPEED	063309.0	1	1002003	4014486491296
4	ENGINE	063285.0	1	1001245	4014486492002
5	DRUM DRIVE VARIABLE SPEED	629737.0	1	1001511	4014486460285
6	FEEDER DRIVE	618123.0	1	1003434	4014486464634
7	FEEDER DRIVE	063940.0	1	1000580	4014486468977
10	FEEDER DRIVE	062294.0	1	1001351	4014486474640
1	FEEDER SHAFT (UPPER)	981678.0	1	1001547	4014486484465
1	FEEDER SHAFT (UPPER)	981678.0	1	1001547	4014486484465

CLAAS JAGUAR 800, 820



No.	Application	OEM - PN	Set	Optibelt AP-Nr.	EAN
1	FOR ACCELERATOR	629732.2	1	1000417	4014486520507
2	FOR SLIP DRIVE	070310.1	1	1000380	4014486466430
4	FOR CORN CRACKER	629763.0	1	1003593	4014486484977
5	FOR CHOPPER DRUM	073202.1	1	1002012	4014486491425
6	AT MECHANICAL GROUND DRIVE	629756.0	1	1001209	4014486497687
6	AT HYDRAULIC GROUND DRIVE	073203.0	1	1001810	4014486488227
7	MOTOR - INTERMEDIATE DRIVE	073199.0	1	1002004	4014486491319
8	FOR AIR CONDITIONING	667560.1	1	1002597	4014486496024
9	FOR ALTERNATOR	133641.0	1	1002596	4014486496017
10	FOR CORN CRACKER	073204.0	1	1001183	4014486490213
11	FOR FEEDER HOUSING	673614.1	1	1001566	4014486484694
1	MAIN DRIVE	077797.0	1	1001270	4014486492378
2	ALTERNATOR DRIVE	512087.0	1	1002588	4014486495812
3	COMPRESSOR DRIVE	052393.1	1	1000122	4014486461336
4	FAN DRIVE	077400.0	1	1000282	4014486464597
5	CLEANING FAN DRIVE	077276.0	1	1000177	4014486462067
6	CORN CRACKER DRIVE	076403.1	1	1001186	4014486490244

CLAAS JAGUAR 830, 840, 85, 850



No.	Application	OEM - PN	Set	Optibelt AP-Nr.	EAN
1	MAIN DRIVE	067745.0	1	1001271	4014486492385
3	CORN CRACKER DRIVE	076403.1	1	1001186	4014486490244
3	CORN CRACKER DRIVE	067789.0	1	1001292	4014486492446
4	CHOPPER DRIVE	984885.0	1	1001810	4014486488227
4	CHOPPER DRIVE	987883.0	1	1001943	4014486490435
1	MAIN DRIVE	077796.0	1	1001314	4014486492774
2	ALTERNATOR DRIVE	512087.0	1	1002588	4014486495812
3	COMPRESSOR DRIVE	052393.1	1	1000122	4014486461336
4	FAN DRIVE	077400.0	1	1000282	4014486464597
5	CLEANING FAN DRIVE	077276.0	1	1000177	4014486462067
6	CORN CRACKER DRIVE	076403.1	1	1001186	4014486490244
6		633030.2	1	1000220	4014486462838
1	MAIN DRIVE	067746.0	1	1001315	4014486492781
3	CORN CRACKER DRIVE	076403.1	1	1001186	4014486490244
3	CORN CRACKER DRIVE	067789.0	1	1001292	4014486492446
4	CHOPPER DRIVE	984885.0	1	1001810	4014486488227
4	CHOPPER DRIVE	987883.0	1	1001943	4014486490435

CLAAS JAGUAR 870, 890, 900, LEXION 405

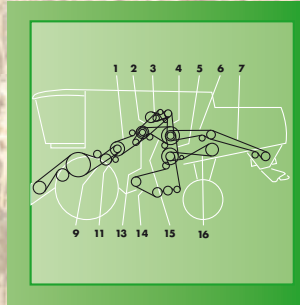
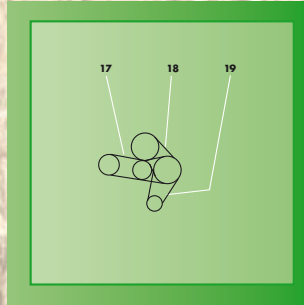
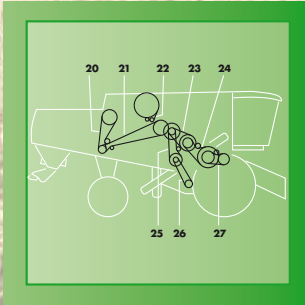

No.	Application	OEM - PN	Set	Optibelt AP-Nr.	EAN
1	MAIN DRIVE	067746.0	1	1001315	4014486492781
3	CORN CRACKER DRIVE	076403.1	1	1001186	4014486490244
3	CORN CRACKER DRIVE	067789.0	1	1001292	4014486492446
4	CHOPPER DRIVE	984885.0	1	1001810	4014486488227
4	CHOPPER DRIVE	987883.0	1	1001943	4014486490435
1	MAIN DRIVE	067747.1	1	1001325	4014486492880
3	CORN CRACKER DRIVE	076403.1	1	1001186	4014486490244
3	CORN CRACKER DRIVE	067789.0	1	1001292	4014486492446
4	CHOPPER DRIVE	984885.0	1	1001810	4014486488227
4	CHOPPER DRIVE	987883.0	1	1001943	4014486490435
1	MAIN DRIVE	067747.1	1	1001325	4014486492880
3	CORN CRACKER DRIVE	076403.1	1	1001186	4014486490244
3	CORN CRACKER DRIVE	067789.0	1	1001292	4014486492446
4	CHOPPER DRIVE	984885.0	1	1001810	4014486488227
4	CHOPPER DRIVE	987883.0	1	1001943	4014486490435
	KNIFE DRIVE	742025.0	1	1000650	4014486470123
	THRESHING DRUM VARIATOR DRIVE	667248.0	1	1001317	4014486497908
1	CUTTERBAR DRIVE	667947.0	1	1001633	4014486485783
2	THRESHING MACHINE	667680.0	1	1003353	4014486490978

CLAAS LEXION 405, 410

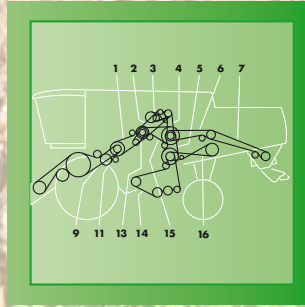
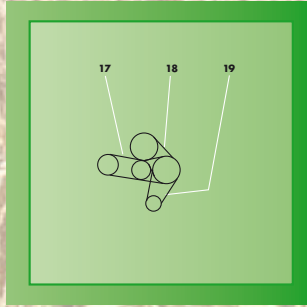
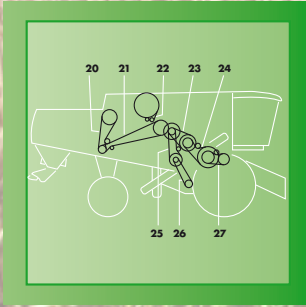

3	DISCHARGE DRIVE GRAIN TANK	667681.0	1	1001583	4014486484908
4	STRAW CHOPPER DRIVE - 1ST STAGE	667981.2	1	1001588	4014486484991
5	SIEVE PAN DRIVE - 2ND STAGE	667252.0	1	1003602	4014486485349
7	STRAW CHOPPER DRIVE - 2ND STAGE	644771.0	1	1000752	4014486471519
11	IMPELLER DRUM DRIVE	667249.0	1	1003591	4014486484762
13	HYDRAULIC PUMP DRIVE	758719.0	1	1003405	4014486463309
14	SIEVE PAN DRIVE 2RD STAGE	667651.0	1	1001706	4014486486834
15	SIEVE PAN DRIVE - 1ST STAGE	644209.0	1	1000699	4014486470826
16	STRAW WALKER DRIVE	667477.0	1	1000387	4014486466508
17	COMPRESSOR DRIVE	667560.1	1	1002597	4014486496024
18	ROTARY SCREEN FAN AND DRIVE	667242.0	1	1000225	4014486463033
19	ALTERNATOR DRIVE STARTER	667673.0	1	1002549	4014486494815
20	AGITATOR DRIVE (REAR)	667973.0	1	1000340	4014486465877
21	AGITATOR DRIVE (FRONT)	667974.0	1	1000411	4014486466744
22	ROTARY SCREEN DRIVE	667561.1	1	1000168	4014486461930
23	THRESHING DRUM VARIATOR DRIVE	661427.0	1	1001228	4014486497847
24	THRESHING CYLINDER	667934.0	1	1001645	4014486485974
25	FAN DRIVE - 1ST STAGE	667957.0	1	1000320	4014486465396
26	FAN INTERMEDIATE DRIVE	667457.0	1	1001079	4014486498233
	KNIFE DRIVE	742025.0	1	1000650	4014486470123
	THRESHING DRUM VARIATOR DRIVE	667248.0	1	1001317	4014486497908

CLAAS LEXION 410

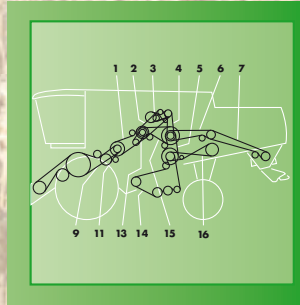
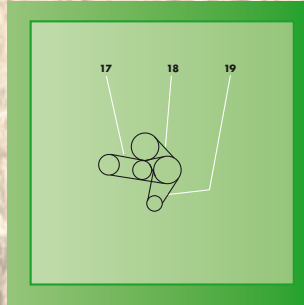
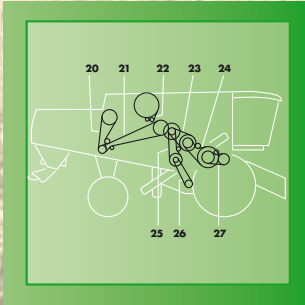

No.	Application	OEM - PN	Set	Optibelt AP-Nr.	EAN
1	CUTTERBAR DRIVE	667947.0	1	1001633	4014486485783
2	THRESHING MACHINE	667680.0	1	1003353	4014486490978
3	DISCHARGE DRIVE GRAIN TANK	667681.0	1	1001583	4014486484908
4	STRAW CHOPPER DRIVE - 1ST STAGE	667981.2	1	1001588	4014486484991
5	SIEVE PAN DRIVE - 2ND STAGE	667252.0	1	1003602	4014486485349
7	STRAW CHOPPER DRIVE - 2ND STAGE	644771.0	1	1000752	4014486471519
11	IMPELLER DRUM DRIVE	667249.0	1	1003591	4014486484762
13	HYDRAULIC PUMP DRIVE	758719.0	1	1003405	4014486463309
14	SIEVE PAN DRIVE 2RD STAGE	667651.0	1	1001706	4014486486834
15	SIEVE PAN DRIVE - 1ST STAGE	644209.0	1	1000699	4014486470826
16	STRAW WALKER DRIVE	667477.0	1	1000387	4014486466508
17	COMPRESSOR DRIVE	667560.1	1	1002597	4014486496024
18	ROTARY SCREEN FAN AND DRIVE	667242.0	1	1000225	4014486463033
19	ALTERNATOR DRIVE STARTER	667673.0	1	1002549	4014486494815
20	AGITATOR DRIVE (REAR)	667973.0	1	1000340	4014486465877
21	AGITATOR DRIVE (FRONT)	667974.0	1	1000411	4014486466744
22	ROTARY SCREEN DRIVE	667561.1	1	1000168	4014486461930
23	THRESHING DRUM VARIATOR DRIVE	661427.0	1	1001228	4014486497847
24	THRESHING CYLINDER	667934.0	1	1001645	4014486485974
25	FAN DRIVE - 1ST STAGE	667957.0	1	1000320	4014486465396
26	FAN INTERMEDIATE DRIVE	667457.0	1	1001079	4014486498233

CLAAS LEXION 410 II



BISO - Schrattecker
BIZON
CASE INTL. HARVESTER
CLAAS
DEUTZ-FAHR
DRONNING-BORG
FENDT
FORTSCHRITT
JOHN DEERE
KRONE
LAVERDA
MASSEY FERGUSON
NEW HOLLAND
ROSTSELMASH

No.	Application	OEM - PN	Set	Optibelt AP-Nr.	EAN
2	CUTTERBAR DRIVE, 1STE STAGE	667255.0	1	1003357	4014486488951
3	THRESHING MECHANISM DRIVE	352371.1	1	1001982	4014486491012
4	GRAIN TANK UNLOADING	667250.0	1	1001586	4014486484960
5	CHOPPER DRIVE 1STE STAGE	667958.3	1	1001593	4014486485080
6	SIEVE PAN, 2ND STAGE	667252.0	1	1003602	4014486485349
7	CHOPPER DRIVE 2ND STAGE	667683.1	1	1000738	4014486471335
8	CHOPPER DRIVE 3RD STAGE ADJUSTABLE CHOPPER	667683.1	1	1000738	4014486471335
8	CHOPPER DRIVE 3RD STAGE RIGID CHOPPER	061701.2	1	1000790	4014486472066
11	SYNCHRONOUS DRIVE	667249.0	1	1003591	4014486484762
12	CUTTERBAR VARIATOR	667530.1	1	1001163	4014486497441
13	CHAFF SPREADER	758719.0	1	1003405	4014486463309
14	CLEANING, 3RD STAGE	667651.0	1	1001706	4014486486834
15	CLEANING, 1ST STAGE	644209.0	1	1000699	4014486470826
16	INTENSIVE SEPARATION SYSTEM, SHORT	667973.0	1	1000340	4014486465877
17	INTENSIVE SEPARATION SYSTEM, LONG	667974.0	1	1000411	4014486466744
18	CHOPPER DRIVE 4TH STAGE	667684.0	1	1000595	4014486469264
19	FINGER ROLLER	509035.1	1	1000430	4014486466973
22	LEXION 410	661427.0	1	1001228	4014486497847
23	LEXION 410	644902.0	1	1001639	4014486485905
25	LEXION 410	667957.0	1	1000320	4014486465396
26	LEXION 410	644843.0	1	1002286	4014486479690
27	FAN VARIATOR	667457.0	1	1001079	4014486498233

CLAAS LEXION 410 II, 415

No.	Application	OEM - PN	Set	Optibelt AP-Nr.	EAN
28	PRE - DRUM DRIVE	667251.1	1	1003601	4014486485219
29	HYDRAULIC REEL DRIVE	829094.0	1	1000245	4014486463712
30	STRAW WALKER DRIVE	667477.0	1	1000387	4014486466508
32	DRUM VARIATOR 2ND STAGE	667248.0	1	1001317	4014486497908
33	RADIATOR SCREEN 2ND STAGE	545689.0	1	1003332	4014486461886
35	FAN DRIVE	796450.0	1	1003969	4014486480610
	KNIFE DRIVE	742025.0	1	1000650	4014486470123
	ROTARY SCREEN DRIVE	667456.0	1	1002554	4014486494914
1	CLUTCH FOR CUTTERBAR DRIVE	667255.0	1	1003357	4014486488951
2	THRESHING MECHANICAL DRIVE	667680.0	1	1003353	4014486490978
3	DISCHARGE DRIVE GRAIN TANK	667681.0	1	1001583	4014486484908
4	STRAW CHOPPER DRIVE - 1ST STAGE	667981.2	1	1001588	4014486484991
5	SIEVE PAN DRIVE - 2ND STAGE	667252.0	1	1003602	4014486485349
8	STRAW CHOPPER DRIVE - 4TH STAGE	667684.0	1	1000595	4014486469264
10	CUTTERBAR DRIVE WITHOUT VARIATOR DRIVE	667551.0	2	1000867	4014486473056
11	IMPELLER DRUM DRIVE	667249.0	1	1003591	4014486484762
13	HYDRAULIC PUMP DRIVE	758719.0	1	1003405	4014486463309
14	SIEVE PAN DRIVE 2RD STAGE	667651.0	1	1001706	4014486486834
15	SIEVE PAN DRIVE - 1ST STAGE	644209.0	1	1000699	4014486470826
16	STRAW WALKER DRIVE	667477.0	1	1000387	4014486466508
17	COMPRESSOR DRIVE	667560.1	1	1002597	4014486496024

CLAAS LEXION 415, 420 MONTANA



18	ROTARY SCREEN FAN AND DRIVE	667242.0	1	1000225	4014486463033
19	ALTERNATOR DRIVE STARTER	667673.0	1	1002549	4014486494815
20	AGITATOR DRIVE (REAR)	667973.0	1	1000340	4014486465877
21	AGITATOR DRIVE (FRONT)	667974.0	1	1000411	4014486466744
22	ROTARY SCREEN DRIVE	667561.1	1	1000168	4014486461930
23	THRESHING DRUM VARIATOR DRIVE	667248.0	1	1001317	4014486497908
24	THRESHING DRUM VARIATOR DRIVE	667458.0	1	1003642	4014486489101
25	FAN DRIVE - 1ST STAGE	742026.0	1	1000328	4014486465587
26	FAN DRIVE - 1ST STAGE	667457.0	1	1001079	4014486498233
2	CUTTERBAR DRIVE, 1STE STAGE	667255.0	1	1003357	4014486488951
3	THRESHING MECHANISM DRIVE	352371.1	1	1001982	4014486491012
4	GRAIN TANK UNLOADING	667250.0	1	1001586	4014486484960
5	CHOPPER DRIVE, 1STE STAGE	667958.3	1	1001593	4014486485080
6	SIEVE PAN, 2ND STAGE	667252.0	1	1003602	4014486485349
7	CHOPPER DRIVE 2ND STAGE	667683.1	1	1000738	4014486471335
8	CHOPPER DRIVE 3RD STAGE ADJUSTABLE CHOPPER	667683.1	1	1000738	4014486471335
11	SYNCHRONOUS DRIVE	667249.0	1	1003591	4014486484762
13	CHAFF SPREADER	758719.0	1	1003405	4014486463309
14	CLEANING, 3RD STAGE	667651.0	1	1001706	4014486486834
15	CLEANING, 1STE STAGE	644209.0	1	1000699	4014486470826
16	INTENSIVE SEPARATION SYSTEM, SHORT	667973.0	1	1000340	4014486465877

CLAAS LEXION 420 MONTANA, 430

No.	Application	OEM - PN	Set	Optibelt AP-Nr.	EAN
17	INTENSIVE SEPARATION SYSTEM, LONG	667974.0	1	1000411	4014486466744
18	CHOPPER DRIVE 4TH STAGE	667684.0	1	1000595	4014486469264
19	FINGER ROLLER	509035.1	1	1000430	4014486466973
22	DRUM VARIATOR	667248.0	1	1001317	4014486497908
23	DRUM DRIVE	176442.1	1	1003641	4014486489033
25	FAN DRIVE	742026.0	1	1000328	4014486465587
26	SUCTION FAN	644781.0	1	1000123	4014486461350
27	FAN VARIATOR	667457.0	1	1001079	4014486498233
28	PRE - DRUM DRIVE	667251.1	1	1003601	4014486485219
29	HYDRAULIC REEL DRIVE	829094.0	1	1000245	4014486463712
30	STRAW WALKER DRIVE	667477.0	1	1000387	4014486466508
32	DRUM VARIATOR 2ND STAGE	667248.0	1	1001317	4014486497908
33	RADIATOR SCREEN 2ND STAGE	545689.0	1	1003332	4014486461886
35	FAN DRIVE	796450.0	1	1003969	4014486480610
	KNIFE DRIVE	742025.0	1	1000650	4014486470123
	ROTARY SCREEN DRIVE	667456.0	1	1002554	4014486494914
1	CLUTCH FOR CUTTERBAR DRIVE	667255.0	1	1003357	4014486488951
2	THRESHING MECHANICAL DRIVE	667680.0	1	1003353	4014486490978
3	DISCHARGE DRIVE GRAIN TANK	667681.0	1	1001583	4014486484908
4	STRAW CHOPPER DRIVE - 1ST STAGE	667981.2	1	1001588	4014486484991
5	SIEVE PAN DRIVE - 2ND STAGE	667252.0	1	1003602	4014486485349

CLAAS LEXION 430



8	STRAW CHOPPER DRIVE - 4TH STAGE	667684.0	1	1000595	4014486469264
10	CUTTERBAR DRIVE WITHOUT VARIATOR DRIVE	667551.0	2	1000867	4014486473056
11	IMPELLER DRUM DRIVE	667249.0	1	1003591	4014486484762
13	HYDRAULIC PUMP DRIVE	758719.0	1	1003405	4014486463309
14	SIEVE PAN DRIVE 2RD STAGE	667651.0	1	1001706	4014486486834
15	SIEVE PAN DRIVE - 1ST STAGE	644209.0	1	1000699	4014486470826
16	STRAW WALKER DRIVE	667477.0	1	1000387	4014486466508
17	COMPRESSOR DRIVE	667560.1	1	1002597	4014486496024
18	ROTARY SCREEN FAN AND DRIVE	667242.0	1	1000225	4014486463033
19	ALTERNATOR DRIVE STARTER	667673.0	1	1002549	4014486494815
20	AGITATOR DRIVE (REAR)	667973.0	1	1000340	4014486465877
21	AGITATOR DRIVE (FRONT)	667974.0	1	1000411	4014486466744
22	ROTARY SCREEN DRIVE	667561.1	1	1000168	4014486461930
23	THRESHING DRUM VARIATOR DRIVE	667248.0	1	1001317	4014486497908
24	THRESHING DRUM VARIATOR DRIVE	667458.0	1	1003642	4014486489101
25	FAN DRIVE - 1ST STAGE	742026.0	1	1000328	4014486465587
26	FAN DRIVE - 1ST STAGE	667457.0	1	1001079	4014486498233

CLAAS LEXION 430 II

No.	Application	OEM - PN	Set	Optibelt AP-Nr.	EAN
2	CUTTERBAR DRIVE, 1STE STAGE	667255.0	1	1003357	4014486488951
3	THRESHING MECHANISM DRIVE	352371.1	1	1001982	4014486491012
4	GRAIN TANK UNLOADING	667250.0	1	1001586	4014486484960
5	CHOPPER DRIVE 1STE STAGE	667958.3	1	1001593	4014486485080
6	SIEVE PAN, 2ND STAGE	667252.0	1	1003602	4014486485349
7	CHOPPER DRIVE 2ND STAGE	667683.1	1	1000738	4014486471335
8	CHOPPER DRIVE 3RD STAGE ADJUSTABLE CHOPPER	667683.1	1	1000738	4014486471335
8	CHOPPER DRIVE 3RD STAGE RIGID CHOPPER	061701.2	1	1000790	4014486472066
11	SYNCHRONOUS DRIVE	667249.0	1	1003591	4014486484762
12	CUTTERBAR VARIATOR	667530.1	1	1001163	4014486497441
13	CHAFF SPREADER	758719.0	1	1003405	4014486463309
14	CLEANING, 3RD STAGE	667651.0	1	1001706	4014486486834
15	CLEANING, 1ST STAGE	644209.0	1	1000699	4014486470826
16	INTENSIVE SEPARATION SYSTEM, SHORT	667973.0	1	1000340	4014486465877
17	INTENSIVE SEPARATION SYSTEM, LONG	667974.0	1	1000411	4014486466744
18	CHOPPER DRIVE 4TH STAGE	667684.0	1	1000595	4014486469264
19	FINGER ROLLER	509035.1	1	1000430	4014486466973
22	DRUM VARIATOR	667248.0	1	1001317	4014486497908
23	DRUM DRIVE	176442.1	1	1003641	4014486489033
25	FAN DRIVE	742026.0	1	1000328	4014486465587
26	SUCTION BLOWER LEXION 430, 420	644781.0	1	1000123	4014486461350
27	FAN VARIATOR	667457.0	1	1001079	4014486498233

CLAAS LEXION 430 II, 430 MONTANA



28	PRE - DRUM DRIVE	667251.1	1	1003601	4014486485219
29	HYDRAULIC REEL DRIVE	829094.0	1	1000245	4014486463712
30	STRAW WALKER DRIVE	667477.0	1	1000387	4014486466508
32	DRUM VARIATOR 2ND STAGE	667248.0	1	1001317	4014486497908
33	RADIATOR SCREEN 2ND STAGE	545689.0	1	1003332	4014486461886
35	FAN DRIVE	796450.0	1	1003969	4014486480610
2	CUTTERBAR DRIVE, 1STE STAGE	667255.0	1	1003357	4014486488951
3	THRESHING MECHANISM DRIVE	352371.1	1	1001982	4014486491012
4	GRAIN TANK UNLOADING	667250.0	1	1001586	4014486484960
5	CHOPPER DRIVE, 1STE STAGE	667958.3	1	1001593	4014486485080
6	SIEVE PAN, 2ND STAGE	667252.0	1	1003602	4014486485349
7	CHOPPER DRIVE 2ND STAGE	667683.1	1	1000738	4014486471335
8	CHOPPER DRIVE 3RD STAGE ADJUSTABLE CHOPPER	667683.1	1	1000738	4014486471335
11	SYNCHRONOUS DRIVE	667249.0	1	1003591	4014486484762
13	CHAFF SPREADER	758719.0	1	1003405	4014486463309
14	CLEANING, 3RD STAGE	667651.0	1	1001706	4014486486834
15	CLEANING, 1STE STAGE	644209.0	1	1000699	4014486470826
16	INTENSIVE SEPARATION SYSTEM, SHORT	667973.0	1	1000340	4014486465877
17	INTENSIVE SEPARATION SYSTEM, LONG	667974.0	1	1000411	4014486466744
18	CHOPPER DRIVE 4TH STAGE	667684.0	1	1000595	4014486469264
19	FINGER ROLLER	509035.1	1	1000430	4014486466973

CLAAS LEXION 430 MONTANA, 440

No.	Application	OEM - PN	Set	Optibelt AP-Nr.	EAN
22	DRUM VARIATOR	667248.0	1	1001317	4014486497908
23	DRUM DRIVE	176442.1	1	1003641	4014486489033
25	FAN DRIVE	742026.0	1	1000328	4014486465587
26	SUCTION FAN	644781.0	1	1000123	4014486461350
27	FAN VARIATOR	667457.0	1	1001079	4014486498233
28	PRE - DRUM DRIVE	667251.1	1	1003601	4014486485219
29	HYDRAULIC REEL DRIVE	829094.0	1	1000245	4014486463712
30	STRAW WALKER DRIVE	667477.0	1	1000387	4014486466508
32	DRUM VARIATOR 2ND STAGE	667248.0	1	1001317	4014486497908
33	RADIATOR SCREEN 2ND STAGE	545689.0	1	1003332	4014486461886
35	FAN DRIVE	796450.0	1	1003969	4014486480610
	KNIFE DRIVE	742025.0	1	1000650	4014486470123
1	CLUTCH FOR CUTTERBAR DRIVE	667255.0	1	1003357	4014486488951
2	THRESHING MECHANISM DRIVE	667453.0	1	1003350	4014486492095
3	DISCHARGE DRIVE GRAIN TANK	667250.0	1	1001586	4014486484960
4	STRAW CHOPPER DRIVE - 1ST STAGE	667958.2	1	1003598	4014486485073
5	SIEVE PAN DRIVE - 2ND STAGE	667252.0	1	1003602	4014486485349
6	STRAW CHOPPER DRIVE - 2ND STAGE	061700.1	1	1003356	4014486486131
7	STRAW CHOPPER DRIVE - 2ND STAGE	061700.1	1	1003356	4014486486131
8	STRAW CHOPPER DRIVE - 4TH STAGE	661093.0	1	1001581	4014486484885
10	CUTTERBAR DRIVE WITH VARIABLE SPEED DRIVE	667551.0	2	1000867	4014486473056

CLAAS LEXION 440, 440 II



11	IMPELLER DRUM DRIVE	667249.0	1	1003591	4014486484762
13	HYDRAULIC PUMP DRIVE	758719.0	1	1003405	4014486463309
14	SIEVE PAN DRIVE 2RD STAGE	667651.0	1	1001706	4014486486834
15	SIEVE PAN DRIVE - 1ST STAGE	644209.0	1	1000699	4014486470826
16	STRAW WALKER DRIVE	667477.0	1	1000387	4014486466508
17	COMPRESSOR DRIVE	667560.1	1	1002597	4014486496024
18	ROTARY SCREEN FAN AND DRIVE	667242.0	1	1000225	4014486463033
19	ROTARY SCREEN DRIVE	667456.0	1	1002554	4014486494914
20	AGITATOR DRIVE (REAR)	667973.0	1	1000340	4014486465877
21	AGITATOR DRIVE (FRONT)	667974.0	1	1000411	4014486466744
22	ROTARY SCREEN DRIVE	667561.1	1	1000168	4014486461930
23	THRESHING DRUM VARIATOR DRIVE	667248.0	1	1001317	4014486497908
24	THRESHING DRUM VARIATOR DRIVE	667458.0	1	1003642	4014486489101
25	FAN DRIVE - 1ST STAGE	742026.0	1	1000328	4014486465587
26	FAN INTERMEDIATE DRIVE	667457.0	1	1001079	4014486498233
2	CUTTERBAR DRIVE, 1STE STAGE	667255.0	1	1003357	4014486488951
3	THRESHING MECHANISM DRIVE	667453.0	1	1003350	4014486492095
4	GRAIN TANK UNLOADING	667250.0	1	1001586	4014486484960
5	CHOPPER DRIVE 1STE STAGE	667958.3	1	1001593	4014486485080
6	SIEVE PAN, 2ND STAGE	667252.0	1	1003602	4014486485349
7	CHOPPER DRIVE 2ND STAGE	061700.1	1	1003356	4014486486131

CLAAS LEXION 440 II

No.	Application	OEM - PN	Set	Optibelt AP-Nr.	EAN
8	CHOPPER DRIVE 3RD STAGE RIGID CHOPPER FROM NO. 54402246	749828.0	1	1001681	4014486486513
8	TO NO. 54401895	749828.0	1	1001681	4014486486513
8	NO. 54401896 - 54402245	628888.0	1	1001684	4014486486551
8	CHOPPER DRIVE 3RD STAGE ADJUSTABLE CHOPPER	061700.1	1	1003356	4014486486131
11	SYNCHRONOUS DRIVE	667249.0	1	1003591	4014486484762
12	CUTTERBAR VARIATOR	667530.1	1	1001163	4014486497441
13	CHAFF SPREADER	758719.0	1	1003405	4014486463309
14	CLEANING, 3RD STAGE	667651.0	1	1001706	4014486486834
15	CLEANING, 1ST STAGE	644209.0	1	1000699	4014486470826
16	INTENSIVE SEPARATION SYSTEM, SHORT	667973.0	1	1000340	4014486465877
17	INTENSIVE SEPARATION SYSTEM, LONG	667974.0	1	1000411	4014486466744
18	CHOPPER DRIVE 4TH STAGE	661093.0	1	1001581	4014486484885
19	FINGER ROLLER	509035.1	1	1000430	4014486466973
22	DRUM VARIATOR	667248.0	1	1001317	4014486497908
23	DRUM DRIVE	176442.1	1	1003641	4014486489033
25	FAN DRIVE	742026.0	1	1000328	4014486465587
26	SUCTION FAN	644781.0	1	1000123	4014486461350
27	FAN VARIATOR	667457.0	1	1001079	4014486498233
28	PRE - DRUM DRIVE	667251.1	1	1003601	4014486485219
29	HYDRAULIC REEL DRIVE	829094.0	1	1000245	4014486463712
30	STRAW WALKER DRIVE	667477.0	1	1000387	4014486466508
32	DRUM VARIATOR 2ND STAGE	667248.0	1	1001317	4014486497908

CLAAS LEXION 440 II, 450 II MTS

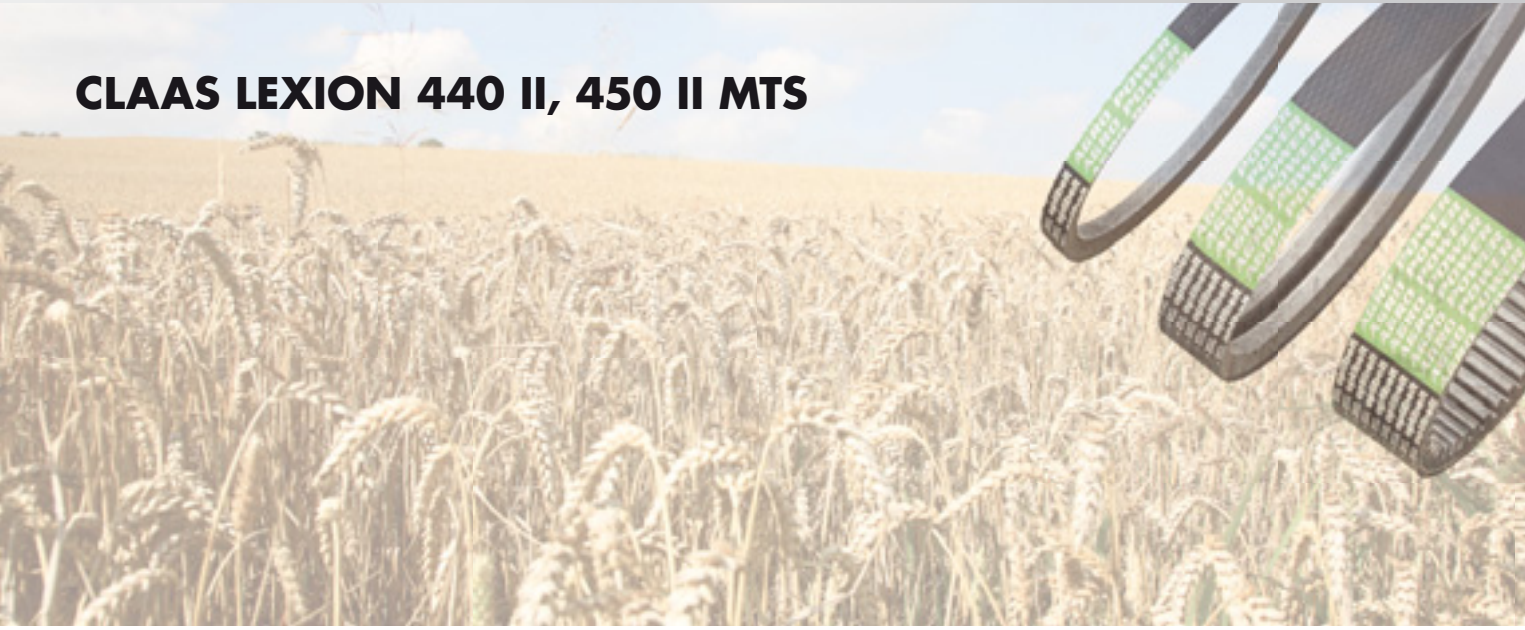

33	RADIATOR SCREEN 2ND STAGE	545689.0	1	1003332	4014486461886
34	ENGINE C9	796474.0	1	1003217	4014486482454
35	FAN DRIVE	796450.0	1	1003969	4014486480610
36	SUCTION BLOWER E - CHANNEL	765985.0	1	1002287	4014486479706
2	CUTTERBAR DRIVE, 1STE STAGE	667255.0	1	1003357	4014486488951
3	THRESHING MECHANISM DRIVE	352403.0	1	1001253	4014486492101
4	GRAIN TANK UNLOADING	667250.0	1	1001586	4014486484960
5	CHOPPER DRIVE 1STE STAGE	667958.3	1	1001593	4014486485080
6	SIEVE PAN 2ND STAGE	667252.0	1	1003602	4014486485349
7	CHOPPER DRIVE 2ND STAGE	061700.1	1	1003356	4014486486131
8	CHOPPER DRIVE 3RD STAGE RIGID CHOPPER FROM NO. 54700050	749828.0	1	1001681	4014486486513
8	TO NO. 54700040	749828.0	1	1001681	4014486486513
8	NO. 54700041 - 54700049	628888.0	1	1001684	4014486486551
8	CHOPPER DRIVE 3RD STAGE ADJUSTABLE CHOPPER	061700.1	1	1003356	4014486486131
11	SYNCHRONOUS DRIVE	667249.0	1	1003591	4014486484762
12	CUTTERBAR VARIATOR	667530.1	1	1001163	4014486497441
13	CHAFF SPREADER	758719.0	1	1003405	4014486463309
14	CLEANING, 3RD STAGE	667651.0	1	1001706	4014486486834
15	CLEANING, 1STE STAGE	644209.0	1	1000699	4014486470826
18	CHOPPER DRIVE 4TH STAGE	661093.0	1	1001581	4014486484885
19	FINGER ROLLER	509035.1	1	1000430	4014486466973

CLAAS LEXION 450 II MTS, 450 TERRA

No.	Application	OEM - PN	Set	Optibelt AP-Nr.	EAN
22	DRUM VARIATOR	667248.0	1	1001317	4014486497908
23	DRUM DRIVE	176442.1	1	1003641	4014486489033
25	FAN DRIVE	742026.0	1	1000328	4014486465587
26	SUCTION FAN	644781.0	1	1000123	4014486461350
27	FAN VARIATOR	667457.0	1	1001079	4014486498233
28	PRE - DRUM DRIVE	667251.1	1	1003601	4014486485219
29	HYDRAULIC REEL DRIVE	829094.0	1	1000245	4014486463712
30	STRAW WALKER DRIVE	667477.0	1	1000387	4014486466508
32	DRUM VARIATOR 2ND STAGE	667248.0	1	1001317	4014486497908
33	RADIATOR SCREEN 2ND STAGE	545689.0	1	1003332	4014486461886
34	ENGINE C9	796474.0	1	1003217	4014486482454
35	FAN DRIVE	796450.0	1	1003969	4014486480610
36	SUCTION BLOWER E - CHANNEL	765985.0	1	1002287	4014486479706
1	1STE STAGE CUTTERBAR	667255.0	1	1003357	4014486488951
2	THRESHING MECHANISM	667453.0	1	1003350	4014486492095
3	GRAIN TANK UNLOADING	667250.0	1	1001586	4014486484960
4	1STE STAGE CHOPPER	667958.3	1	1001593	4014486485080
5	2ND STAGE CLEANING	667252.0	1	1003602	4014486485349
6	2ND STAGE CHOPPER	061700.1	1	1003356	4014486486131
7	3RD STAGE CHOPPER	061700.1	1	1003356	4014486486131
8	4TH STAGE CHOPPER	661093.0	1	1001581	4014486484885

CLAAS LEXION 450 TERRA



11	IMPELLER DRUM	667249.0	1	1003591	4014486484762
13	HYDRAULIC PUMP	758719.0	1	1003405	4014486463309
14	3RD STAGE CLEANING	667651.0	1	1001706	4014486486834
15	1STE STAGE CLEANING	644209.0	1	1000699	4014486470826
16	STRAW WALKER	667477.0	1	1000387	4014486466508
17	COMPRESSOR	667560.1	1	1002597	4014486496024
18	MOTOR FAN	667242.0	1	1000225	4014486463033
19	1STE STAGE RADIATOR SCREEN	667456.0	1	1002554	4014486494914
20	REAR FEED RAKE	667973.0	1	1000340	4014486465877
21	FRONT FEED RAKE	667974.0	1	1000411	4014486466744
22	2ND STAGE RADIATOR SCREEN	667561.1	1	1000168	4014486461930
23	DRUM VARIABLE SPEED DRIVE	667248.0	1	1001317	4014486497908
24	THRESHING DRUM AT DISC D 593 MM OPTIONAL	667255.0	1	1003357	4014486488951
24	THRESHING DRUM FROM NO. 45800017	176442.1	1	1003641	4014486489033
24	THRESHING DRUM TO NO. 45700016	667458.0	1	1003642	4014486489101
25	1STE STAGE BLOWER	742026.0	1	1000328	4014486465587
26	FAN VARIABLE SPEED DRIVE	667457.0	1	1001079	4014486498233
27	ACCELERATOR	667251.1	1	1003601	4014486485219
28	SUCTION FAN	644781.0	1	1000123	4014486461350

CLAAS LEXION 460

No.	Application	OEM - PN	Set	Optibelt AP-Nr.	EAN
	KNIFE DRIVE	742025.0	1	1000650	4014486470123
1	CLUTCH FOR CUTTERBAR DRIVE	667255.0	1	1003357	4014486488951
2	THRESHING MECHANISM DRIVE	667453.0	1	1003350	4014486492095
3	DISCHARGE DRIVE GRAIN TANK	667250.0	1	1001586	4014486484960
4	STRAW CHOPPER DRIVE - 1ST STAGE	667958.2	1	1003598	4014486485073
5	SIEVE PAN DRIVE - 2ND STAGE	667252.0	1	1003602	4014486485349
6	STRAW CHOPPER DRIVE - 2ND STAGE	061700.1	1	1003356	4014486486131
7	STRAW CHOPPER DRIVE - 2ND STAGE	061700.1	1	1003356	4014486486131
8	STRAW CHOPPER DRIVE - 4TH STAGE	661093.0	1	1001581	4014486484885
10	CUTTERBAR DRIVE WITH VARIABLE SPEED DRIVE	667551.0	2	1000867	4014486473056
11	IMPELLER DRUM DRIVE	667249.0	1	1003591	4014486484762
13	HYDRAULIC PUMP DRIVE	758719.0	1	1003405	4014486463309
14	SIEVE PAN DRIVE 2RD STAGE	667651.0	1	1001706	4014486486834
15	SIEVE PAN DRIVE - 1ST STAGE	644209.0	1	1000699	4014486470826
16	STRAW WALKER DRIVE	667477.0	1	1000387	4014486466508
17	COMPRESSOR DRIVE	667560.1	1	1002597	4014486496024
18	ROTARY SCREEN FAN AND DRIVE	667242.0	1	1000225	4014486463033
19	ROTARY SCREEN DRIVE	667456.0	1	1002554	4014486494914
20	AGITATOR DRIVE (REAR)	667973.0	1	1000340	4014486465877
21	AGITATOR DRIVE (FRONT)	667974.0	1	1000411	4014486466744
22	ROTARY SCREEN DRIVE	667561.1	1	1000168	4014486461930
23	THRESHING DRUM VARIATOR DRIVE	667248.0	1	1001317	4014486497908

CLAAS LEXION 460, 460 II



24	THRESHING DRUM VARIATOR DRIVE	667458.0	1	1003642	4014486489101
25	FAN DRIVE - 1ST STAGE	742026.0	1	1000328	4014486465587
26	FAN INTERMEDIATE DRIVE	667457.0	1	1001079	4014486498233
2	CUTTERBAR DRIVE, 1STE STAGE	667255.0	1	1003357	4014486488951
3	THRESHING MECHANISM DRIVE	352403.0	1	1001253	4014486492101
4	GRAIN TANK UNLOADING	667250.0	1	1001586	4014486484960
5	CHOPPER DRIVE 1STE STAGE	667958.3	1	1001593	4014486485080
6	SIEVE PAN, 2ND STAGE	667252.0	1	1003602	4014486485349
7	CHOPPER DRIVE 2ND STAGE	061700.1	1	1003356	4014486486131
8	CHOPPER DRIVE 3RD STAGE RIGID CHOPPER FROM NO. 54402246	749828.0	1	1001681	4014486486513
8	TO NO. 54401895	749828.0	1	1001681	4014486486513
8	NO. 54401896 - 54402245	628888.0	1	1001684	4014486486551
8	CHOPPER DRIVE 3RD STAGE ADJUSTABLE CHOPPER	061700.1	1	1003356	4014486486131
11	SYNCHRONOUS DRIVE	667249.0	1	1003591	4014486484762
12	CUTTERBAR VARIATOR	667530.1	1	1001163	4014486497441
13	CHAFF SPREADER	758719.0	1	1003405	4014486463309
14	CLEANING, 3RD STAGE	667651.0	1	1001706	4014486486834
15	CLEANING, 1ST STAGE	644209.0	1	1000699	4014486470826
16	INTENSIVE SEPERATION SYSTEM, SHORT	667973.0	1	1000340	4014486465877
17	INTENSIVE SEPERATION SYSTEM, LONG	667974.0	1	1000411	4014486466744
18	CHOPPER DRIVE 4TH STAGE	661093.0	1	1001581	4014486484885

CLAAS LEXION 460 II

No.	Application	OEM - PN	Set	Optibelt AP-Nr.	EAN
19	FINGER ROLLER	509035.1	1	1000430	4014486466973
22	DRUM VARIATOR	667248.0	1	1001317	4014486497908
23	DRUM DRIVE	176442.1	1	1003641	4014486489033
25	FAN DRIVE	742026.0	1	1000328	4014486465587
26	SUCTION FAN	644781.0	1	1000123	4014486461350
27	FAN VARIATOR	667457.0	1	1001079	4014486498233
28	PRE - DRUM DRIVE	667251.1	1	1003601	4014486485219
29	HYDRAULIC REEL DRIVE	829094.0	1	1000245	4014486463712
30	STRAW WALKER DRIVE	667477.0	1	1000387	4014486466508
32	DRUM VARIATOR 2ND STAGE	667248.0	1	1001317	4014486497908
33	RADIATOR SCREEN 2ND STAGE	545689.0	1	1003332	4014486461886
34	ENGINE C9	796474.0	1	1003217	4014486482454
35	FAN DRIVE	796450.0	1	1003969	4014486480610
36	SUCTION BLOWER E - CHANNEL	765985.0	1	1002287	4014486479706

CLAAS LEXION 460 II MTS



BISO - Schrattecker
BIZON
CASE INTL. HARVESTER
CLAAS
DEUTZ-FAHR
DRONNING-BORG
FENDT
FORTSCHRITT
JOHN DEERE
KRONE
LAVERDA
MASSEY FERGUSON
ROTSSELMASH NEW HOLLAND

No.	Application	OEM - PN	Set	Optibelt AP-Nr.	EAN
2	CUTTERBAR DRIVE, 1STE STAGE	667255.0	1	1003357	4014486488951
3	THRESHING MECHANISM DRIVE	352403.0	1	1001253	4014486492101
4	GRAIN TANK UNLOADING	667250.0	1	1001586	4014486484960
5	CHOPPER DRIVE 1STE STAGE	667958.3	1	1001593	4014486485080
6	SIEVE PAN 2ND STAGE	667252.0	1	1003602	4014486485349
7	CHOPPER DRIVE 2ND STAGE	061700.1	1	1003356	4014486486131
8	CHOPPER DRIVE 3RD STAGE RIGID CHOPPER FROM NO. 54700050	749828.0	1	1001681	4014486486513
8	TO NO. 54700040	749828.0	1	1001681	4014486486513
8	NO. 54700041 - 54700049	628888.0	1	1001684	4014486486551
8	CHOPPER DRIVE 3RD STAGE ADJUSTABLE CHOPPER	061700.1	1	1003356	4014486486131
11	SYNCHRONOUS DRIVE	667249.0	1	1003591	4014486484762
12	CUTTERBAR VARIATOR	667530.1	1	1001163	4014486497441
13	CHAFF SPREADER	758719.0	1	1003405	4014486463309
14	CLEANING, 3RD STAGE	667651.0	1	1001706	4014486486834
15	CLEANING, 1STE STAGE	644209.0	1	1000699	4014486470826
18	CHOPPER DRIVE 4TH STAGE	661093.0	1	1001581	4014486484885
19	FINGER ROLLER	509035.1	1	1000430	4014486466973
22	DRUM VARIATOR	667248.0	1	1001317	4014486497908
23	DRUM DRIVE	176442.1	1	1003641	4014486489033
25	FAN DRIVE	742026.0	1	1000328	4014486465587
26	SUCTION FAN	644781.0	1	1000123	4014486461350
27	FAN VARIATOR	667457.0	1	1001079	4014486498233

CLAAS LEXION 460 II MTS, 460 TERRA

No.	Application	OEM - PN	Set	Optibelt AP-Nr.	EAN
28	PRE - DRUM DRIVE	667251.1	1	1003601	4014486485219
29	HYDRAULIC REEL DRIVE	829094.0	1	1000245	4014486463712
30	STRAW WALKER DRIVE	667477.0	1	1000387	4014486466508
32	DRUM VARIATOR 2ND STAGE	667248.0	1	1001317	4014486497908
33	RADIATOR SCREEN 2ND STAGE	545689.0	1	1003332	4014486461886
34	ENGINE C9	796474.0	1	1003217	4014486482454
35	FAN DRIVE	796450.0	1	1003969	4014486480610
36	SUCTION BLOWER E - CHANNEL	765985.0	1	1002287	4014486479706
1	1STE STAGE CUTTERBAR	667255.0	1	1003357	4014486488951
2	THRESHING MECHANISM	667453.0	1	1003350	4014486492095
3	GRAIN TANK UNLOADING	667250.0	1	1001586	4014486484960
4	1STE STAGE CHOPPER	667958.3	1	1001593	4014486485080
5	2ND STAGE CLEANING	667252.0	1	1003602	4014486485349
6	2ND STAGE CHOPPER	061700.1	1	1003356	4014486486131
7	3RD STAGE CHOPPER	061700.1	1	1003356	4014486486131
8	4TH STAGE CHOPPER	661093.0	1	1001581	4014486484885
11	IMPELLER DRUM	667249.0	1	1003591	4014486484762
13	HYDRAULIC PUMP	758719.0	1	1003405	4014486463309
14	3RD STAGE CLEANING	667651.0	1	1001706	4014486486834
15	1STE STAGE CLEANING	644209.0	1	1000699	4014486470826
16	STRAW WALKER	667477.0	1	1000387	4014486466508

CLAAS LEXION 460 TERRA



17	COMPRESSOR	667560.1	1	1002597	4014486496024
18	MOTOR FAN	667242.0	1	1000225	4014486463033
19	1STE STAGE RADIATOR SCREEN	667456.0	1	1002554	4014486494914
20	REAR FEED RAKE	667973.0	1	1000340	4014486465877
21	FRONT FEED RAKE	667974.0	1	1000411	4014486466744
22	2ND STAGE RADIATOR SCREEN	667561.1	1	1000168	4014486461930
23	DRUM VARIABLE SPEED DRIVE	667248.0	1	1001317	4014486497908
24	THRESHING DRUM AT DISC D 593 MM OPTIONAL	667255.0	1	1003357	4014486488951
24	THRESHING DRUM FROM NO. 45800017	176442.1	1	1003641	4014486489033
24	THRESHING DRUM TO NO. 45700016	667458.0	1	1003642	4014486489101
25	1STE STAGE BLOWER	742026.0	1	1000328	4014486465587
26	FAN VARIABLE SPEED DRIVE	667457.0	1	1001079	4014486498233
27	ACCELERATOR	667251.1	1	1003601	4014486485219
28	SUCTION FAN	644781.0	1	1000123	4014486461350

CLAAS LEXION 470

No.	Application	OEM - PN	Set	Optibelt AP-Nr.	EAN
2	CUTTERBAR DRIVE - 1ST STAGE	667255.0	1	1003357	4014486488951
3	THRESHING MECHANISM DRIVE	352403.0	1	1001253	4014486492101
4	DISCHARGE DRIVE GRAIN TANK	667250.0	1	1001586	4014486484960
5	CHOPPER DRIVE - 1ST STAGE	667958.3	1	1001593	4014486485080
6	SIEVE PAN DRIVE - 2ND STAGE	667252.0	1	1003602	4014486485349
7	CHOPPER DRIVE - 2ND STAGE	061700.1	1	1003356	4014486486131
8	CHOPPER DRIVE - 3RD STAGE	350463.0	1	1001665	4014486486278
11	SYNCHRONOUS DRIVE	667249.0	1	1003591	4014486484762
12	CUTTERBAR DRIVE WITH VARIABLE SPEED DRIVE	667530.1	1	1001163	4014486497441
13	CHAFF SPREADER DRIVE	758719.0	1	1003405	4014486463309
14	CLEANING - 3RD STAGE	667651.0	1	1001706	4014486486834
15	CLEANING - 1ST STAGE	644209.0	1	1000699	4014486470826
16	HYBRID DRIVE - 2ND STAGE	629510.1	1	1003634	4014486488623
17	HYBRID DRIVE - 1ST STAGE	749886.1	1	1001928	4014486489972
22	DRUM DRIVE VARIABLE SPEED	667248.0	1	1001317	4014486497908
23	DRUM DRIVE	176442.1	1	1003641	4014486489033
25	FAN DRIVE	742026.0	1	1000328	4014486465587
26	SUCTION FAN	644781.0	1	1000123	4014486461350
27	FAN DRIVE VARIABLE SPEED	667457.0	1	1001079	4014486498233
28	PRE-DRUM DRIVE	667251.1	1	1003601	4014486485219
29	HYDRAULIC REEL PUMP DRIVE	829094.0	1	1000245	4014486463712
31	HYBRID VARIABLE SPEED DRIVE	667248.0	1	1001317	4014486497908

CLAAS LEXION 470, 470 MONTANA



32	RADIATOR SCREEN - 2ND STAGE	545689.0	1	1003332	4014486461886
33	ENGINE C9	796474.0	1	1003217	4014486482454
34	FAN DRIVE	796450.0	1	1003969	4014486480610
2	CUTTERBAR DRIVE, 1STE STAGE	667255.0	1	1003357	4014486488951
3	THRESHING MECHANISM DRIVE	352403.0	1	1001253	4014486492101
4	GRAIN TANK UNLOADING	667250.0	1	1001586	4014486484960
5	CHOPPER DRIVE 1STE STAGE	667958.3	1	1001593	4014486485080
6	SIEVE PAN, 2ND STAGE	667252.0	1	1003602	4014486485349
7	CHOPPER DRIVE 2ND STAGE	061700.1	1	1003356	4014486486131
8	CHOPPER DRIVE 3RD STAGE	350463.0	1	1001665	4014486486278
11	SYNCHRONOUS DRIVE	667249.0	1	1003591	4014486484762
13	CHAFF SPREADER	758719.0	1	1003405	4014486463309
14	CLEANING, 3RD STAGE	667651.0	1	1001706	4014486486834
15	CLEANING, 1STE STAGE	644209.0	1	1000699	4014486470826
16	HYBRID DRIVE, 2ND STAGE	629510.1	1	1003634	4014486488623
17	HYBRID DRIVE, 1STE STAGE	749886.1	1	1001928	4014486489972
22	DRUM VARIATOR	667248.0	1	1001317	4014486497908
23	DRUM DRIVE	176442.1	1	1003641	4014486489033
25	FAN DRIVE	742026.0	1	1000328	4014486465587
26	SUCTION FAN	644781.0	1	1000123	4014486461350
27	FAN VARIATOR	667457.0	1	1001079	4014486498233

CLAAS LEXION 470 MONTANA



No.	Application	OEM - PN	Set	Optibelt AP-Nr.	EAN
28	PRE - DRUM DRIVE	667251.1	1	1003601	4014486485219
29	HYDRAULIC REEL DRIVE	829094.0	1	1000245	4014486463712
31	HYBRID VARIABLE SPEED DRIVE	667248.0	1	1001317	4014486497908
32	RADIATOR SCREEN 2ND STAGE	545689.0	1	1003332	4014486461886
33	ENGINE C9	796474.0	1	1003217	4014486482454
34	FAN DRIVE	796450.0	1	1003969	4014486480610

CLAAS LEXION 480

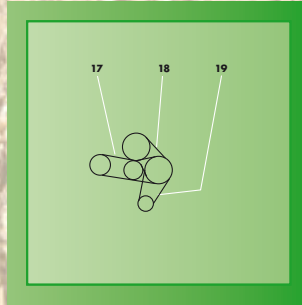
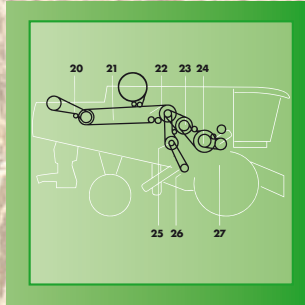
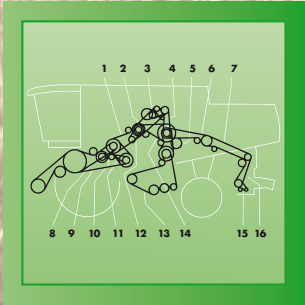

No.	Application	OEM - PN	Set	Optibelt AP-Nr.	EAN
	KNIFE DRIVE	742025.0	1	1000650	4014486470123
1	CLUTCH FOR CUTTERBAR DRIVE	667255.0	1	1003357	4014486488951
2	TENSIONER FOR THRESHING MECHANICAL DRIVE	667881.0	1	1001320	4014486492828
3	DISCHARGE DRIVE GRAIN TANK	667250.0	1	1001586	4014486484960
4	STRAW CHOPPER DRIVE - 1ST STAGE	644685.1	1	1003359	4014486488449
5	SIEVE PAN DRIVE - 2ND STAGE	667252.0	1	1003602	4014486485349
6	STRAW CHOPPER DRIVE - 2ND STAGE	061700.1	1	1003356	4014486486131
7	STRAW CHOPPER DRIVE - 2ND STAGE	661298.0	1	1001630	4014486485738
7	STRAW CHOPPER DRIVE - 2ND STAGE	749712.0	1	1003611	4014486486230
9	CUTTERBAR DRIVE WITH VARIABLE SPEED DRIVE	667551.0	2	1000867	4014486473056
10	IMPELLER DRUM DRIVE	667249.0	1	1003591	4014486484762
12	HYDRAULIC PUMP DRIVE	233843.1	1	1000237	4014486463408
12	HYDRAULIC PUMP DRIVE	758719.0	1	1003405	4014486463309
13	SIEVE PAN DRIVE 2RD STAGE	667651.0	1	1001706	4014486486834
14	SIEVE PAN DRIVE - 1ST STAGE	644209.0	1	1000699	4014486470826
15	UNI SPREADER DRIVE - 2ND STAGE	667891.0	1	1001013	4014486487954
16	UNI SPREADER DRIVE - 1ST STAGE	667798.2	1	1000310	4014486465198
17	COMPRESSOR DRIVE	667560.1	1	1002597	4014486496024
18	ROTARY SCREEN FAN AND DRIVE	667242.0	1	1000225	4014486463033
19	ROTARY SCREEN DRIVE	667456.0	1	1002554	4014486494914
20	HYBRID DRIVE - 2ND STAGE	667427.0	1	1001839	4014486488654
20	HYBRID DRIVE - 2ND STAGE	667983.0	1	1003645	4014486489194

CLAAS LEXION 480, 480 II

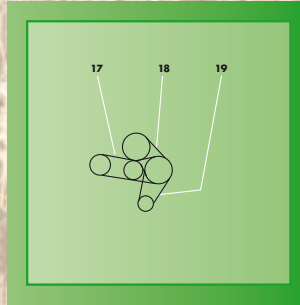
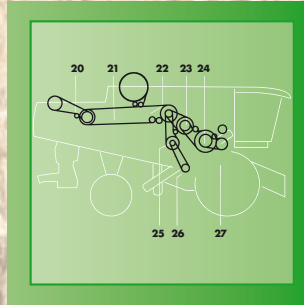
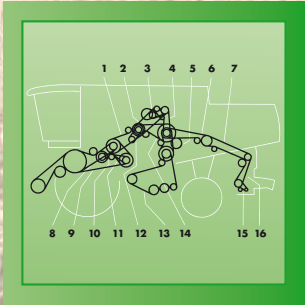

No.	Application	OEM - PN	Set	Optibelt AP-Nr.	EAN
21	HYBRID DRIVE - 1ST STAGE	667554.0	1	1001926	4014486489941
22	ROTARY SCREEN DRIVE	667561.1	1	1000168	4014486461930
23	THRESHING DRUM VARIATOR DRIVE	667248.0	1	1001317	4014486497908
24	THRESHING DRUM VARIATOR DRIVE	667458.0	1	1003642	4014486489101
25	FAN DRIVE - 1ST STAGE	742026.0	1	1000328	4014486465587
26	FAN INTERMEDIATE DRIVE	667457.0	1	1001079	4014486498233
2	CUTTERBAR DRIVE, 1STE STAGE	667255.0	1	1003357	4014486488951
3	THRESHING MECHANISM DRIVE	667881.0	1	1001320	4014486492828
4	GRAIN TANK UNLOADING	667250.0	1	1001586	4014486484960
5	CHOPPER DRIVE 1STE STAGE	644966.0	1	1001823	4014486488425
6	SIEVE PAN, 2ND STAGE	667252.0	1	1003602	4014486485349
7	CHOPPER DRIVE, 2ND STAGE	644889.0	1	1001658	4014486486148
8	STRENGTHENED DRIVE	644890.0	1	1001664	4014486486247
8	CHOPPER DRIVE, 3RD STAGE ONLY FOR RICE	350463.0	1	1001665	4014486486278
11	SYNCHRONOUS DRIVE	667249.0	1	1003591	4014486484762
12	CUTTERBAR VARIATOR	667530.1	1	1001163	4014486497441
13	AT SPREADER FAN	233843.1	1	1000237	4014486463408
13	AT CHAFF SPREADER	758719.0	1	1003405	4014486463309
14	CLEANING, 3RD STAGE	644866.0	1	1003618	4014486486865
15	CLEANING, 1STE STAGE	644209.0	1	1000699	4014486470826
16	HYBRID DRIVE, 2ND STAGE	629510.1	1	1003634	4014486488623

CLAAS LEXION 480 II, 480 II MTS



17	HYBRID DRIVE, 1STE STAGE	749886.1	1	1001928	4014486489972
18	RADIATOR SCREEN 2ND STAGE	545689.0	1	1003332	4014486461886
19	FAN DRIVE / C12	761979.1	1	1002668	4014486482027
22	DRUM VARIATOR	667248.0	1	1001317	4014486497908
23	DRUM DRIVE	176442.1	1	1003641	4014486489033
25	FAN DRIVE	742026.0	1	1000328	4014486465587
26	SUCTION FAN	644781.0	1	1000123	4014486461350
27	FAN VARIATOR	667457.0	1	1001079	4014486498233
28	PRE - DRUM DRIVE	667251.1	1	1003601	4014486485219
29	HYDRAULIC REEL DRIVE	829094.0	1	1000245	4014486463712
31	HYBRID VARIABLE SPEED DRIVE	667248.0	1	1001317	4014486497908
32	SPREADER FAN, 2ND STAGE	667891.1	1	1001012	4014486487947
33	SPREADER FAN, 1STE STAGE	644942.0	1	1001385	4014486475012
34	SUCTION BLOWER E - CHANNEL	765985.0	1	1002287	4014486479706
2	CUTTERBAR DRIVE, 1STE STAGE	667255.0	1	1003357	4014486488951
3	THRESHING MECHANISM DRIVE	667881.0	1	1001320	4014486492828
4	GRAIN TANK UNLOADING	667250.0	1	1001586	4014486484960
5	CHOPPER DRIVE, 1STE STAGE	644966.0	1	1001823	4014486488425
6	SIEVE PAN, 2ND STAGE	667252.0	1	1003602	4014486485349
7	CHOPPER DRIVE 2ND STAGE	644889.0	1	1001658	4014486486148
8	STRENGTHENED DRIVE	644890.0	1	1001664	4014486486247

CLAAS LEXION 480 II MTS

No.	Application	OEM - PN	Set	Optibelt AP-Nr.	EAN
8	CHOPPER DRIVE 3RD STAGE ONLY FOR RICE	350463.0	1	1001665	4014486486278
11	SYNCHRONOUS DRIVE	667249.0	1	1003591	4014486484762
12	CUTTERBAR VARIATOR	667530.1	1	1001163	4014486497441
13	AT SPREADER FAN	233843.1	1	1000237	4014486463408
13	AT CHAFF SPREADER	758719.0	1	1003405	4014486463309
14	CLEANING, 3RD STAGE	644866.0	1	1003618	4014486486865
15	CLEANING, 1STE STAGE	644209.0	1	1000699	4014486470826
16	HYBRID DRIVE, 2ND STAGE	629510.1	1	1003634	4014486488623
17	HYBRID DRIVE, 1STE STAGE	749886.1	1	1001928	4014486489972
18	RADIATOR SCREEN 2ND STAGE	545689.0	1	1003332	4014486461886
19	FAN DRIVE / C12	761979.1	1	1002668	4014486482027
22	DRUM VARIATOR	667248.0	1	1001317	4014486497908
23	DRUM DRIVE	176442.1	1	1003641	4014486489033
25	FAN DRIVE	742026.0	1	1000328	4014486465587
26	SUCTION FAN	644781.0	1	1000123	4014486461350
27	FAN VARIATOR	667457.0	1	1001079	4014486498233
28	PRE - DRUM DRIVE	667251.1	1	1003601	4014486485219
29	HYDRAULIC REEL DRIVE	829094.0	1	1000245	4014486463712
31	HYBRID VARIABLE SPEED DRIVE	667248.0	1	1001317	4014486497908
32	SPREADER FAN, 2ND STAGE	667891.1	1	1001012	4014486487947
33	SPREADER FAN, 1STE STAGE	644942.0	1	1001385	4014486475012
34	SUCTION BLOWER E - CHANNEL	765985.0	1	1002287	4014486479706

CLAAS LEXION 480 TERRA



No.	Application	OEM - PN	Set	Optibelt AP-Nr.	EAN
1	1STE STAGE CUTTERBAR	667255.0	1	1003357	4014486488951
2	THRESHING MECHANISM	667881.0	1	1001320	4014486492828
3	GRAIN TANK UNLOADING	667250.0	1	1001586	4014486484960
4	1STE STAGE CHOPPER FROM NO. 46800071	644966.0	1	1001823	4014486488425
4	1STE STAGE CHOPPER TO NO. 46800070	644685.1	1	1003359	4014486488449
5	2ND STAGE CLEANING	667252.0	1	1003602	4014486485349
6	2ND STAGE CHOPPER FROM NO. 46800071	644889.0	1	1001658	4014486486148
6	2ND STAGE CHOPPER TO NO. 46800070	061700.1	1	1003356	4014486486131
7	3RD STAGE CHOPPER FROM NO. 46800071	644890.0	1	1001664	4014486486247
7	3RD STAGE CHOPPER TO NO. 46800070	749712.0	1	1003611	4014486486230
10	IMPELLER DRUM	667249.0	1	1003591	4014486484762
12	STRAW SPREADER	233843.1	1	1000237	4014486463408
12	STRAW SPREADER	758719.0	1	1003405	4014486463309
13	3RD STAGE CLEANING	644866.0	1	1003618	4014486486865
14	1STE STAGE CLEANING	644209.0	1	1000699	4014486470826
15	2ND STAGE SPREADER BLOWER	667891.1	1	1001012	4014486487947
16	1STE EACH SPREADER BLOWER TO NO. 46800033	667798.2	1	1000310	4014486465198
16	1STE EACH SPREADER BLOWER FROM NO. 46800034	644942.0	1	1001385	4014486475012
17	COMPRESSOR	667560.1	1	1002597	4014486496024
18	MOTOR FAN	667242.0	1	1000225	4014486463033
19	1STE STAGE RADIATOR SCREEN	667456.0	1	1002554	4014486494914
20	2ND STAGE HYBRID FROM NO. 46800081	629510.1	1	1003634	4014486488623

CLAAS LEXION 480 TERRA, 510

No.	Application	OEM - PN	Set	Optibelt AP-Nr.	EAN
20	BEI N = 300 MIN-1	667458.0	1	1003642	4014486489101
20	2ND STAGE HYBRID TO NO. 46800080	667983.0	1	1003645	4014486489194
21	1STE STAGE HYBRID TO NO. 46800080	667554.0	1	1001926	4014486489941
21	1STE STAGE HYBRID FROM NO. 46800081	749886.1	1	1001928	4014486489972
22	2ND STAGE RADIATOR SCREEN	667561.1	1	1000168	4014486461930
23	DRUM VARIBALE SPEED DRIVE	667248.0	1	1001317	4014486497908
24	THRESHING DRUM AT DISC 644878.1 OPTIONAL	667255.0	1	1003357	4014486488951
24	THRESHING DRUM	176442.1	1	1003641	4014486489033
25	1STE STAGE BLOWER	742026.0	1	1000328	4014486465587
26	FAN VARIABLE SPEED DRIVE	667457.0	1	1001079	4014486498233
27	ACCELERATOR	667251.1	1	1003601	4014486485219
28	SUCTION FAN	644781.0	1	1000123	4014486461350
2	CUTTERBAR DRIVE, 1STE STAGE	644892.0	1	1001860	4014486488968
3	THRESHING MECHANISM DRIVE P02/540/541/560/ P02/670/671/680/681	352371.1	1	1001982	4014486491012
3	THRESHING MECHANISM DRIVE P02/590/591/660/661	667453.0	1	1003350	4014486492095
4	GRAIN TANK UNLOADING	667250.0	1	1001586	4014486484960
5	CHOPPER DRIVE 1STE STAGE AT MOTOR 3126B AND C9 - EX- HAUST LEVEL 3A	667958.3	1	1001593	4014486485080
5	CHOPPER DRIVE 1STE STAGE AT MOTOR C6.6	355696.0	1	1003596	4014486485042
6	SIEVE PAN, 2ND STAGE	667252.0	1	1003602	4014486485349
7	CHOPPER DRIVE, 2ND STAGE	061700.1	1	1003356	4014486486131
8	CHOPPER DRIVE, 3RD STAGE RIGID CHOPPER	628888.0	1	1001684	4014486486551

CLAAS LEXION 510



11	SYNCHRONOUS DRIVE	667249.0	1	1003591	4014486484762
12	CUTTERBAR VARIATOR	667530.1	1	1001163	4014486497441
13	CHAFF SPREADER	746508.1	1	1000266	4014486464252
14	CLEANING, 3RD STAGE	667651.0	1	1001706	4014486486834
15	CLEANING, 1STE STAGE	644209.0	1	1000699	4014486470826
19	FINGER ROLLER	628991.0	1	1000433	4014486467000
22	DRUM VARIATOR	661427.0	1	1001228	4014486497847
22	DRUM VARIATOR FROM NO. 58300369	667248.0	1	1001317	4014486497908
23	DRUM DRIVE	644902.0	1	1001639	4014486485905
23	DRUM DRIVE	176442.1	1	1003641	4014486489033
25	FAN DRIVE	778717.1	2	1002796	4014486465433
26	SUCTION BLOWER	644843.0	1	1002286	4014486479690
27	FAN VARIATOR	667457.0	1	1001079	4014486498233
28	PRE - DRUM DRIVE	667251.1	1	1003601	4014486485219
29	HYDRAULIC REEL DRIVE	829094.0	1	1000245	4014486463712
30	STRAW WALKER DRIVE	667477.0	1	1000387	4014486466508
33	RADIATOR SCREEN 2ND STAGE	545689.0	1	1003332	4014486461886
34	AT MOTOR 3126B	796474.0	1	1003217	4014486482454
35	AT MOTOR C9	584627.1	1	1002652	4014486481259
35	AT MOTOR C6.6	580157.0	1	1003786	4014486481334
35	FAN DRIVE AT MOTOR 3126B	796450.0	1	1003969	4014486480610
36	SUCTION BLOWER E - CHANNEL	765985.0	1	1002287	4014486479706

CLAAS LEXION 520 MONTANA

No.	Application	OEM - PN	Set	Optibelt AP-Nr.	EAN
2	CUTTERBAR DRIVE 1STE STAGE	644892.0	1	1001860	4014486488968
3	THRESHING MECHANISM DRIVE P02/660/661 FROM NO. 58200137	352403.0	1	1001253	4014486492101
3	THRESHING MECHANISM DRIVE P02/540/541/670/671	352371.1	1	1001982	4014486491012
3	THRESHING MECHANISM DRIVE P02/590/591 P02/660/661	667453.0	1	1003350	4014486492095
4	GRAIN TANK UNLOADING	667250.0	1	1001586	4014486484960
5	CHOPPER DRIVE 1STE STAGE AT MOTOR 3126B, C9	667958.3	1	1001593	4014486485080
5	CHOPPER DRIVE 1STE STAGE AT MOTOR C6.6	355696.0	1	1003596	4014486485042
6	SIEVE PAN 2ND STAGE	667252.0	1	1003602	4014486485349
7	CHOPPER DRIVE 2ND STAGE	061700.1	1	1003356	4014486486131
8	CHOPPER DRIVE 3RD STAGE RIGID CHOPPER	628888.0	1	1001684	4014486486551
11	SYNCHRONOUS DRIVE	667249.0	1	1003591	4014486484762
12	CUTTERBAR VARIATOR	667530.1	1	1001163	4014486497441
13	CHAFF SPREADER	746508.1	1	1000266	4014486464252
14	CLEANING, 3RD STAGE	667651.0	1	1001706	4014486486834
15	CLEANING, 1STE STAGE	644209.0	1	1000699	4014486470826
19	FINGER ROLLER	628991.0	1	1000433	4014486467000
22	DRUM VARIATOR	667248.0	1	1001317	4014486497908
23	DRUM DRIVE	176442.1	1	1003641	4014486489033
25	FAN DRIVE	746506.0	1	1000332	4014486465709
26	SUCTION FAN	644781.0	1	1000123	4014486461350
27	FAN VARIATOR	667457.0	1	1001079	4014486498233
28	PRE - DRUM DRIVE	667251.1	1	1003601	4014486485219

CLAAS LEXION 520 MONTANA, 530



29	HYDRAULIC REEL DRIVE	829094.0	1	1000245	4014486463712
30	STRAW WALKER DRIVE	667477.0	1	1000387	4014486466508
33	RADIATOR SCREEN 2ND STAGE	545689.0	1	1003332	4014486461886
34	AT MOTOR 3126B	796474.0	1	1003217	4014486482454
35	AT MOTOR C9	584627.1	1	1002652	4014486481259
35	AT MOTOR C6.6	580157.0	1	1003786	4014486481334
35	FAN DRIVE AT MOTOR 3126B	796450.0	1	1003969	4014486480610
36	SUCTION BLOWER E - CHANNEL	765985.0	1	1002287	4014486479706
2	CUTTERBAR DRIVE, 1STE STAGE	644892.0	1	1001860	4014486488968
3	THRESHING MECHANISM DRIVE P02/540/541/560/ P02/670/671/680/681	352371.1	1	1001982	4014486491012
3	THRESHING MECHANISM DRIVE P02/590/591/660/661	667453.0	1	1003350	4014486492095
4	GRAIN TANK UNLOADING	667250.0	1	1001586	4014486484960
5	CHOPPER DRIVE 1STE STAGE AT MOTOR 3126B AND C9 - EX- HAUST LEVEL 3A	667958.3	1	1001593	4014486485080
5	CHOPPER DRIVE 1STE STAGE AT MOTOR C6.6	355696.0	1	1003596	4014486485042
6	SIEVE PAN, 2ND STAGE	667252.0	1	1003602	4014486485349
7	CHOPPER DRIVE, 2ND STAGE	061700.1	1	1003356	4014486486131
8	CHOPPER DRIVE, 3RD STAGE RIGID CHOPPER	628888.0	1	1001684	4014486486551
11	SYNCHRONOUS DRIVE	667249.0	1	1003591	4014486484762
12	CUTTERBAR VARIATOR	667530.1	1	1001163	4014486497441
13	CHAFF SPREADER	746508.1	1	1000266	4014486464252
14	CLEANING, 3RD STAGE	667651.0	1	1001706	4014486486834

CLAAS LEXION 530



No.	Application	OEM - PN	Set	Optibelt AP-Nr.	EAN
15	CLEANING, 1STE STAGE	644209.0	1	1000699	4014486470826
19	FINGER ROLLER	628991.0	1	1000433	4014486467000
22	DRUM VARIATOR FROM NO. 58300369	667248.0	1	1001317	4014486497908
23	DRUM DRIVE LEXION 530, 520, 510 FROM NO. 58300369	176442.1	1	1003641	4014486489033
25	FAN DRIVE	746506.0	1	1000332	4014486465709
26	SUCTION BLOWER	644781.0	1	1000123	4014486461350
27	FAN VARIATOR	667457.0	1	1001079	4014486498233
28	PRE - DRUM DRIVE	667251.1	1	1003601	4014486485219
29	HYDRAULIC REEL DRIVE	829094.0	1	1000245	4014486463712
30	STRAW WALKER DRIVE	667477.0	1	1000387	4014486466508
33	RADIATOR SCREEN 2ND STAGE	545689.0	1	1003332	4014486461886
34	AT MOTOR 3126B	796474.0	1	1003217	4014486482454
35	AT MOTOR C9	584627.1	1	1002652	4014486481259
35	AT MOTOR C6.6	580157.0	1	1003786	4014486481334
35	FAN DRIVE AT MOTOR 3126B	796450.0	1	1003969	4014486480610
36	SUCTION BLOWER E - CHANNEL	765985.0	1	1002287	4014486479706

CLAAS LEXION 530 MONTANA



No.	Application	OEM - PN	Set	Optibelt AP-Nr.	EAN
2	CUTTERBAR DRIVE 1STE STAGE	644892.0	1	1001860	4014486488968
3	THRESHING MECHANISM DRIVE P02/660/661 FROM NO. 58200137	352403.0	1	1001253	4014486492101
3	THRESHING MECHANISM DRIVE P02/540/541/670/671	352371.1	1	1001982	4014486491012
3	THRESHING MECHANISM DRIVE P02/590/591 P02/660/661	667453.0	1	1003350	4014486492095
4	GRAIN TANK UNLOADING	667250.0	1	1001586	4014486484960
5	CHOPPER DRIVE 1STE STAGE AT MOTOR 3126B, C9	667958.3	1	1001593	4014486485080
5	CHOPPER DRIVE 1STE STAGE AT MOTOR C6.6	355696.0	1	1003596	4014486485042
6	SIEVE PAN 2ND STAGE	667252.0	1	1003602	4014486485349
7	CHOPPER DRIVE 2ND STAGE	061700.1	1	1003356	4014486486131
8	CHOPPER DRIVE 3RD STAGE RIGID CHOPPER	628888.0	1	1001684	4014486486551
11	SYNCHRONOUS DRIVE	667249.0	1	1003591	4014486484762
12	CUTTERBAR VARIATOR	667530.1	1	1001163	4014486497441
13	CHAFF SPREADER	746508.1	1	1000266	4014486464252
14	CLEANING, 3RD STAGE	667651.0	1	1001706	4014486486834
15	CLEANING, 1STE STAGE	644209.0	1	1000699	4014486470826
19	FINGER ROLLER	628991.0	1	1000433	4014486467000
22	DRUM VARIATOR	667248.0	1	1001317	4014486497908
23	DRUM DRIVE	176442.1	1	1003641	4014486489033
25	FAN DRIVE	746506.0	1	1000332	4014486465709
26	SUCTION FAN	644781.0	1	1000123	4014486461350
27	FAN VARIATOR	667457.0	1	1001079	4014486498233
28	PRE - DRUM DRIVE	667251.1	1	1003601	4014486485219

CLAAS LEXION 530 MONTANA, 540

No.	Application	OEM - PN	Set	Optibelt AP-Nr.	EAN
29	HYDRAULIC REEL DRIVE	829094.0	1	1000245	4014486463712
30	STRAW WALKER DRIVE	667477.0	1	1000387	4014486466508
33	RADIATOR SCREEN 2ND STAGE	545689.0	1	1003332	4014486461886
34	AT MOTOR 3126B	796474.0	1	1003217	4014486482454
35	AT MOTOR C9	584627.1	1	1002652	4014486481259
35	AT MOTOR C6.6	580157.0	1	1003786	4014486481334
35	FAN DRIVE AT MOTOR 3126B	796450.0	1	1003969	4014486480610
36	SUCTION BLOWER E - CHANNEL	765985.0	1	1002287	4014486479706
2	CUTTERBAR DRIVE - 1ST STAGE	644892.0	1	1001860	4014486488968
3	THRESHING MECHANISM ENGINE C9	352403.0	1	1001253	4014486492101
3	THRESHING MECHANISM AT CATERPILLAR C13, C10	667881.0	1	1001320	4014486492828
3	THRESHING MECHANISM ENGINE 3126B, C6.6	667453.0	1	1003350	4014486492095
4	DISCHARGE DRIVE GRAIN TANK	667250.0	1	1001586	4014486484960
5	CHOPPER DRIVE - 1ST STAGE AT MOTOR C13, C10, C9 AND 3126B	667958.3	1	1001593	4014486485080
5	CHOPPER DRIVE - 1ST STAGE AT MOTOR C6.6	355696.0	1	1003596	4014486485042
6	SIEVE PAN DRIVE - 2ND STAGE	667252.0	1	1003602	4014486485349
7	CHOPPER DRIVE - 2ND STAGE	061700.1	1	1003356	4014486486131
8	CHOPPER DRIVE - 3RD STAGE RIGID CHOPPER	628888.0	1	1001684	4014486486551
11	SYNCHRONOUS DRIVE	667249.0	1	1003591	4014486484762
12	CUTTERBAR DRIVE WITH VARIABLE SPEED DRIVE	667530.1	1	1001163	4014486497441
13	CHAFF SPREADER DRIVE	746508.1	1	1000266	4014486464252

CLAAS LEXION 540



14	CLEANING - 3RD STAGE	667651.0	1	1001706	4014486486834
15	CLEANING - 1ST STAGE	644209.0	1	1000699	4014486470826
19	FINGER ROLLER	628991.0	1	1000433	4014486467000
22	DRUM DRIVE VARIABLE SPEED	667248.0	1	1001317	4014486497908
23	DRUM DRIVE	176442.1	1	1003641	4014486489033
25	FAN DRIVE	746506.0	1	1000332	4014486465709
26	SUCTION FAN	644781.0	1	1000123	4014486461350
27	FAN DRIVE VARIABLE SPEED	667457.0	1	1001079	4014486498233
28	PRE-DRUM DRIVE	667251.1	1	1003601	4014486485219
29	HYDRAULIC REEL PUMP DRIVE	829094.0	1	1000245	4014486463712
30	STRAW WALKER DRIVE	667477.0	1	1000387	4014486466508
33	RADIATOR SCREEN - 2ND STAGE	545689.0	1	1003332	4014486461886
34	ENGINE 3126 B	796474.0	1	1003217	4014486482454
35	FAN DRIVE C9-EXHAUST LEVEL 3A	584627.1	1	1002652	4014486481259
35	FAN DRIVE (UP TO NR. 58401486)	743910.1	1	1003202	4014486482041
35	FAN DRIVE AT MOTOR C6.6	580157.0	1	1003786	4014486481334
35	FAN DRIVE - ENGINE 3126B AND AT C9-EMISSION STANDARD	796450.0	1	1003969	4014486480610
36	SUCTION BLOWER E-CHANNEL	765985.0	1	1002287	4014486479706

CLAAS LEXION 550 MONTANA

No.	Application	OEM - PN	Set	Optibelt AP-Nr.	EAN
2	CUTTERBAR DRIVE 1STE STAGE	644892.0	1	1001860	4014486488968
3	THRESHING MECHANISM DRIVE ENGINE C9	352403.0	1	1001253	4014486492101
3	THRESHING MECHANISM DRIVE ENGINE C10	667881.0	1	1001320	4014486492828
4	GRAIN TANK UNLOADING	667250.0	1	1001586	4014486484960
5	CHOPPER DRIVE 1STE STAGE	667958.3	1	1001593	4014486485080
6	SIEVE PAN 2ND STAGE	667252.0	1	1003602	4014486485349
7	CHOPPER DRIVE 2ND STAGE	061700.1	1	1003356	4014486486131
8	CHOPPER DRIVE 3RD STAGE RIGID CHOPPER	628888.0	1	1001684	4014486486551
11	SYNCHRONOUS DRIVE	667249.0	1	1003591	4014486484762
12	CUTTERBAR VARIATOR	667530.1	1	1001163	4014486497441
13	CHAFF SPREADER	746508.1	1	1000266	4014486464252
14	CLEANING 3RD STAGE	667651.0	1	1001706	4014486486834
15	CLEANING 1STE STAGE	644209.0	1	1000699	4014486470826
19	FINGER ROLLER	628991.0	1	1000433	4014486467000
22	DRUM VARIATOR	667248.0	1	1001317	4014486497908
23	DRUM DRIVE	176442.1	1	1003641	4014486489033
25	FAN DRIVE	746506.0	1	1000332	4014486465709
26	SUCTION FAN	644781.0	1	1000123	4014486461350
27	FAN VARIATOR	667457.0	1	1001079	4014486498233
28	PRE - DRUM DRIVE	667251.1	1	1003601	4014486485219
29	HYDRAULIC REEL DRIVE	829094.0	1	1000245	4014486463712
30	STRAW WALKER DRIVE	667477.0	1	1000387	4014486466508

CLAAS LEXION 550 MONTANA, 560

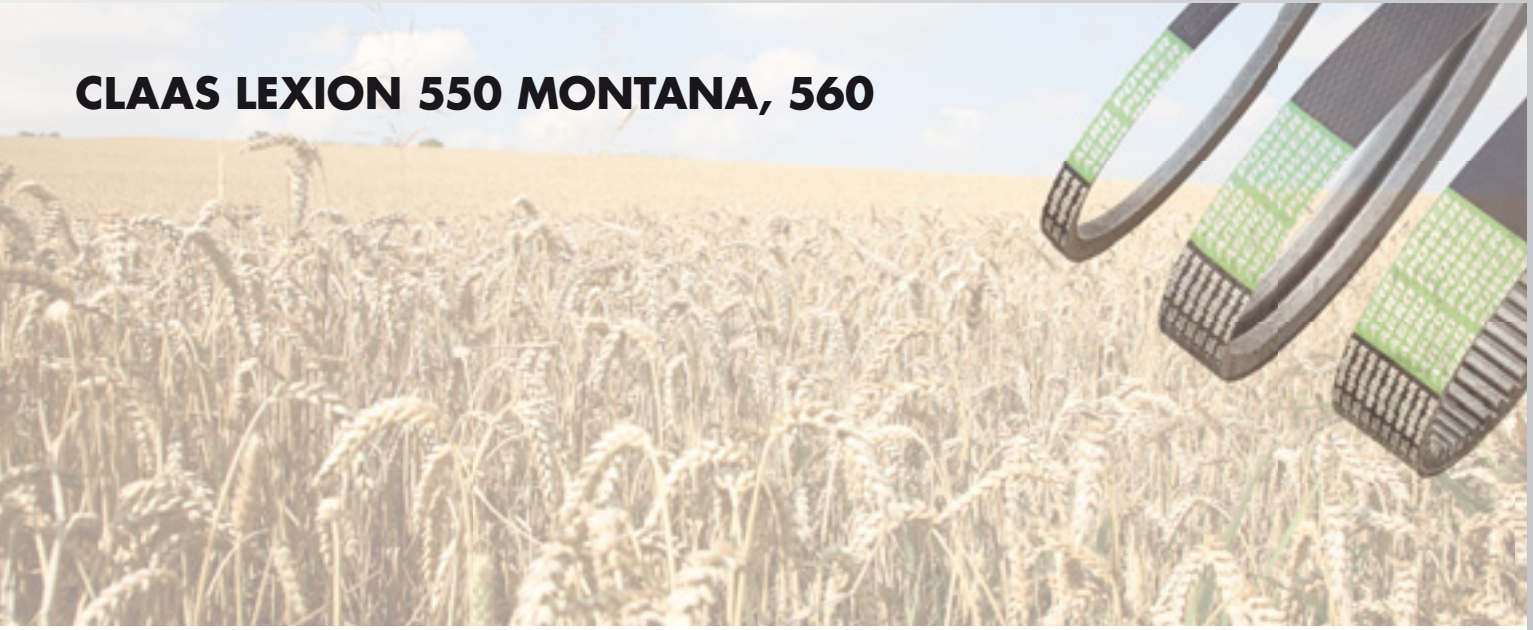

33	RADIATOR SCREEN 2ND STAGE	545689.0	1	1003332	4014486461886
35	FAN DRIVE C9 EXHAUST LEVEL 3A	584627.1	1	1002652	4014486481259
35	FAN DRIVE ENGINE C10 TO NO. 58000035	743910.1	1	1003202	4014486482041
35	FAN DRIVE C9 EMISSION STANDARD 2	796450.0	1	1003969	4014486480610
36	SUCTION BLOWER E - CHANNEL	765985.0	1	1002287	4014486479706
2	CUTTERBAR DRIVE - 1ST STAGE	644892.0	1	1001860	4014486488968
3	THRESHING MECHANISM ENGINE C9	352403.0	1	1001253	4014486492101
3	THRESHING MECHANISM AT CATERPILLAR C13, C10	667881.0	1	1001320	4014486492828
3	THRESHING MECHANISM ENGINE 3126B, C6.6	667453.0	1	1003350	4014486492095
4	DISCHARGE DRIVE GRAIN TANK	667250.0	1	1001586	4014486484960
5	CHOPPER DRIVE - 1ST STAGE AT MOTOR C13, C10, C9 AND 3126B	667958.3	1	1001593	4014486485080
5	CHOPPER DRIVE - 1ST STAGE AT MOTOR C6.6	355696.0	1	1003596	4014486485042
6	SIEVE PAN DRIVE - 2ND STAGE	667252.0	1	1003602	4014486485349
7	CHOPPER DRIVE - 2ND STAGE	061700.1	1	1003356	4014486486131
8	CHOPPER DRIVE - 3RD STAGE RIGID CHOPPER	628888.0	1	1001684	4014486486551
11	SYNCHRONOUS DRIVE	667249.0	1	1003591	4014486484762
12	CUTTERBAR DRIVE WITH VARIABLE SPEED DRIVE	667530.1	1	1001163	4014486497441
13	CHAFF SPREADER DRIVE	746508.1	1	1000266	4014486464252
14	CLEANING - 3RD STAGE	667651.0	1	1001706	4014486486834
15	CLEANING - 1ST STAGE	644209.0	1	1000699	4014486470826
19	FINGER ROLLER	628991.0	1	1000433	4014486467000

CLAAS LEXION 560, 560 MONTANA

No.	Application	OEM - PN	Set	Optibelt AP-Nr.	EAN
22	DRUM DRIVE VARIABLE SPEED	667248.0	1	1001317	4014486497908
23	DRUM DRIVE	176442.1	1	1003641	4014486489033
25	FAN DRIVE	746506.0	1	1000332	4014486465709
26	SUCTION FAN	644781.0	1	1000123	4014486461350
27	FAN DRIVE VARIABLE SPEED	667457.0	1	1001079	4014486498233
28	PRE-DRUM DRIVE	667251.1	1	1003601	4014486485219
29	HYDRAULIC REEL PUMP DRIVE	829094.0	1	1000245	4014486463712
30	STRAW WALKER DRIVE	667477.0	1	1000387	4014486466508
33	RADIATOR SCREEN - 2ND STAGE	545689.0	1	1003332	4014486461886
34	ENGINE 3126 B	796474.0	1	1003217	4014486482454
35	FAN DRIVE C9-EXHAUST LEVEL 3A	584627.1	1	1002652	4014486481259
35	FAN DRIVE (UP TO NR. 58401486)	743910.1	1	1003202	4014486482041
35	FAN DRIVE AT MOTOR C6.6	580157.0	1	1003786	4014486481334
35	FAN DRIVE - ENGINE 3126B AND AT C9-EMISSION STANDARD	796450.0	1	1003969	4014486480610
36	SUCTION BLOWER E-CHANNEL	765985.0	1	1002287	4014486479706
2	CUTTERBAR DRIVE 1STE STAGE	644892.0	1	1001860	4014486488968
3	THRESHING MECHANISM DRIVE ENGINE C9	352403.0	1	1001253	4014486492101
3	THRESHING MECHANISM DRIVE ENGINE C10	667881.0	1	1001320	4014486492828
4	GRAIN TANK UNLOADING	667250.0	1	1001586	4014486484960
5	CHOPPER DRIVE 1STE STAGE	667958.3	1	1001593	4014486485080
6	SIEVE PAN 2ND STAGE	667252.0	1	1003602	4014486485349

CLAAS LEXION 560 MONTANA



7	CHOPPER DRIVE 2ND STAGE	061700.1	1	1003356	4014486486131
8	CHOPPER DRIVE 3RD STAGE RIGID CHOPPER	628888.0	1	1001684	4014486486551
11	SYNCHRONOUS DRIVE	667249.0	1	1003591	4014486484762
12	CUTTERBAR VARIATOR	667530.1	1	1001163	4014486497441
13	CHAFF SPREADER	746508.1	1	1000266	4014486464252
14	CLEANING 3RD STAGE	667651.0	1	1001706	4014486486834
15	CLEANING 1STE STAGE	644209.0	1	1000699	4014486470826
19	FINGER ROLLER	628991.0	1	1000433	4014486467000
22	DRUM VARIATOR	667248.0	1	1001317	4014486497908
23	DRUM DRIVE	176442.1	1	1003641	4014486489033
25	FAN DRIVE	746506.0	1	1000332	4014486465709
26	SUCTION FAN	644781.0	1	1000123	4014486461350
27	FAN VARIATOR	667457.0	1	1001079	4014486498233
28	PRE - DRUM DRIVE	667251.1	1	1003601	4014486485219
29	HYDRAULIC REEL DRIVE	829094.0	1	1000245	4014486463712
30	STRAW WALKER DRIVE	667477.0	1	1000387	4014486466508
33	RADIATOR SCREEN 2ND STAGE	545689.0	1	1003332	4014486461886
35	FAN DRIVE C9 EXHAUST LEVEL 3A	584627.1	1	1002652	4014486481259
35	FAN DRIVE ENGINE C10 TO NO. 58000035	743910.1	1	1003202	4014486482041
35	FAN DRIVE C9 EMISSION STANDARD 2	796450.0	1	1003969	4014486480610
36	SUCTION BLOWER E - CHANNEL	765985.0	1	1002287	4014486479706

CLAAS LEXION 570

No.	Application	OEM - PN	Set	Optibelt AP-Nr.	EAN
2	CUTTERBAR DRIVE - 1ST STAGE	644892.0	1	1001860	4014486488968
3	THRESHING MECHANISM DRIVE	667452.1	1	1001302	4014486492606
4	DISCHARGE DRIVE GRAIN TANK	667250.0	1	1001586	4014486484960
5	CHOPPER DRIVE - 1ST STAGE	667958.3	1	1001593	4014486485080
6	SIEVE PAN DRIVE - 2ND STAGE (FROM NR. 58500163-58500093-107)	644902.0	1	1001639	4014486485905
6	TO NR. 58500092 -NR. 58500108-162	667252.0	1	1003602	4014486485349
7	CHOPPER DRIVE - 2ND STAGE	061700.1	1	1003356	4014486486131
8	CHOPPER DRIVE - 3RD STAGE	628978.0	1	1001670	4014486486346
11	SYNCHRONOUS DRIVE	667249.0	1	1003591	4014486484762
12	CUTTERBAR DRIVE WITH VARIABLE SPEED DRIVE	667530.1	1	1001163	4014486497441
13	CHAFF SPREADER DRIVE	746508.1	1	1000266	4014486464252
14	CLEANING (TO NR. 58500092 - NR. 58500108-162)	667651.0	1	1001706	4014486486834
14	CLEANING - 3RD STAGE (FROM NR. 58500163-58500093-107)	756466.0	1	1003613	4014486486384
15	CLEANING - 1ST STAGE	644209.0	1	1000699	4014486470826
16	HYBRID DRIVE - 2ND STAGE (UP TO NR. 58500162)	749895.0	1	1001828	4014486488494
16	HYBRID DRIVE - 2ND STAGE (FROM NR. 58500163)	628792.0	1	1001834	4014486488586
17	HYBRID DRIVE - 1ST STAGE	749886.1	1	1001928	4014486489972
22	DRUM DRIVE VARIABLE SPEED	667248.0	1	1001317	4014486497908
23	DRUM DRIVE	176442.1	1	1003641	4014486489033
25	FAN DRIVE (FROM NR. 58500163-NR. 58500093-107)	667957.0	1	1000320	4014486465396
25	FAN DRIVE (TO NR. 58500092 -NR. 58500108-162)	746506.0	1	1000332	4014486465709
26	SUCTION BLOWER (TO NR. 58500092 -NR. 58500108-162)	644781.0	1	1000123	4014486461350

CLAAS LEXION 570



26	SUCTION BLOWER (FROM NR. 58500163-NR. 58500093-107)	667367.0	1	1002582	4014486495638
27	FAN DRIVE VARIABLE SPEED (FROM NR. 58500163-NR. 58500093-107)	744785.0	1	1000326	4014486465525
27	FAN DRIVE VARIABLE SPEED (TO NR. 58100092 - NR. 58500108-162)	667457.0	1	1001079	4014486498233
28	PRE-DRUM DRIVE	667251.1	1	1003601	4014486485219
29	HYDRAULIC REEL PUMP DRIVE	829094.0	1	1000245	4014486463712
31	HYBRID VARIABLE SPEED DRIVE (UP TO NR. 58500162)	667248.0	1	1001317	4014486497908
32	RADIATOR SCREEN - 2ND STAGE	545689.0	1	1003332	4014486461886
34	FAN DRIVE (UP TO NR. 58500252)	743910.1	1	1003202	4014486482041
35	SUCTION BLOWER E.-CHANNEL	765985.0	1	1002287	4014486479706
36	FROM NR. 58500163-NR. 58500093-107	628847.1	1	1001213	4014486497724

CLAAS LEXION 570 MONTANA

No.	Application	OEM - PN	Set	Optibelt AP-Nr.	EAN
2	CUTTERBAR DRIVE, 1STE STAGE	644892.0	1	1001860	4014486488968
3	THRESHING MECHANISM DRIVE	667452.1	1	1001302	4014486492606
4	GRAIN TANK UNLOADING	667250.0	1	1001586	4014486484960
5	CHOPPER DRIVE 1STE STAGE	667958.3	1	1001593	4014486485080
6	SIEVE PAN 2ND STAGE FROM NO. 58100038	644902.0	1	1001639	4014486485905
6	TO NO. 58100037	667252.0	1	1003602	4014486485349
7	CHOPPER DRIVE 2ND STAGE FROM NO. 58100187	644889.0	1	1001658	4014486486148
7	CHOPPER DRIVE 2ND STAGE TO NO. 58100186	061700.1	1	1003356	4014486486131
8	CHOPPER DRIVE 3RD STAGE	628978.0	1	1001670	4014486486346
11	SYNCHRONOUS DRIVE	667249.0	1	1003591	4014486484762
12	CUTTERBAR VARIATOR	667530.1	1	1001163	4014486497441
13	CHAFF SPREADER	746508.1	1	1000266	4014486464252
14	TO NO. 58100037	667651.0	1	1001706	4014486486834
14	CLEANING, 3RD STAGE FROM NO. 58100038	756466.0	1	1003613	4014486486384
15	CLEANING 1STE STAGE	644209.0	1	1000699	4014486470826
16	HYBRID DRIVE 2ND STAGE TO NO. 58100037	749895.0	1	1001828	4014486488494
16	HYBRID DRIVE 2ND STAGE FROM NO. 58100038	628792.0	1	1001834	4014486488586
17	TO NO. 58100037	749886.1	1	1001928	4014486489972
17	HYBRID DRIVE 1STE FROM NO. 58100038	644961.0	1	1001930	4014486490008
22	DRUM VARIATOR	667248.0	1	1001317	4014486497908
23	DRUM DRIVE	176442.1	1	1003641	4014486489033
25	FAN DRIVE FROM NO. 58100038	667957.0	1	1000320	4014486465396

CLAAS LEXION 570 MONTANA



25	TO NO. 58100037	746506.0	1	1000332	4014486465709
26	TO NO. 58100037	644781.0	1	1000123	4014486461350
26	SUCTION BLOWER FROM NO. 58100038	667367.0	1	1002582	4014486495638
27	FAN VARIATOR FROM NO. 58100038	744785.0	1	1000326	4014486465525
27	TO NO. 58100037	667457.0	1	1001079	4014486498233
28	PRE - DRUM DRIVE	667251.1	1	1003601	4014486485219
29	HYDRAULIC REEL DRIVE	829094.0	1	1000245	4014486463712
31	FROM NO. 58100038	667248.0	1	1001317	4014486497908
32	HYBRID VARIABLE SPEED DRIVE TO NO. 58100037	545689.0	1	1003332	4014486461886
34	FAN DRIVE FROM NO. 58100038	743910.1	1	1003202	4014486482041
35	FAN DRIVE TO NO. 58100037	765985.0	1	1002287	4014486479706
36	SUCTION BLOWER E - CHANNEL FROM NO. 58100038	628847.1	1	1001213	4014486497724

CLAAS LEXION 580

No.	Application	OEM - PN	Set	Optibelt AP-Nr.	EAN
2	CUTTERBAR DRIVE - 1ST STAGE	644892.0	1	1001860	4014486488968
3	THRESHING MECHANISM DRIVE	644884.0	1	1001321	4014486492835
4	DISCHARGE DRIVE GRAIN TANK	667981.2	1	1001588	4014486484991
5	CHOPPER DRIVE - 1ST STAGE	644885.0	1	1001825	4014486488456
6	SIEVE PAN DRIVE - 2ND STAGE	667252.0	1	1003602	4014486485349
7	CHOPPER DRIVE - 2ND STAGE	644889.0	1	1001658	4014486486148
8	STRENGTHENED DRIVE	644890.0	1	1001664	4014486486247
8	CHOPPER DRIVE - 3RD STAGE ONLY FOR RICE	628978.0	1	1001670	4014486486346
11	SYNCHRONOUS DRIVE	667249.0	1	1003591	4014486484762
12	CUTTERBAR DRIVE WITH VARIABLE SPEED DRIVE	667530.1	1	1001163	4014486497441
13	AT SPREADER FAN	233843.1	1	1000237	4014486463408
13	AT CHAFF-, STRAW- AND RADIAL SPREADER	746508.1	1	1000266	4014486464252
14	CLEANING - 3RD STAGE	644866.0	1	1003618	4014486486865
15	CLEANING - 1ST STAGE	644209.0	1	1000699	4014486470826
16	HYBRID DRIVE - 2ND STAGE (UP TO NR. 58600056)	749895.0	1	1001828	4014486488494
16	HYBRID DRIVE - 2ND STAGE (FROM NR. 58600057)	628792.0	1	1001834	4014486488586
17	HYBRID DRIVE - 1ST STAGE	749886.1	1	1001928	4014486489972
18	RADIATOR SCREEN - 2ND STAGE	545689.0	1	1003332	4014486461886
20	ENGINE	744873.0	1	1001338	4014486483543
22	DRUM DRIVE VARIABLE SPEED	667248.0	1	1001317	4014486497908
23	DRUM DRIVE	644965.0	1	1001864	4014486489040
25	FAN DRIVE	746506.0	1	1000332	4014486465709

CLAAS LEXION 580



26	SUCTION FAN	644781.0	1	1000123	4014486461350
27	FAN DRIVE VARIABLE SPEED	667457.0	1	1001079	4014486498233
28	PRE-DRUM DRIVE	667251.1	1	1003601	4014486485219
29	HYDRAULIC REEL PUMP DRIVE	829094.0	1	1000245	4014486463712
31	HYBRID VARIABLE SPEED DRIVE (UP TO NR. 58600056)	667248.0	1	1001317	4014486497908
32	SPREADER FAN - 2ND STAGE	667891.1	1	1001012	4014486487947
33	SPREADER FAN - 1ST STAGE (TO NR. 58600861)	644942.0	1	1001385	4014486475012
33	SPREADER FAN - 1ST STAGE (FROM NR. 58600862)	667252.0	1	1003602	4014486485349
34	SUCTION BLOWER E.-CHANNEL	765985.0	1	1002287	4014486479706
35	FEEDER BASE	661425.0	1	1000357	4014486466140
36	FEEDER BASE	758719.0	1	1003405	4014486463309

CLAAS LEXION 580 R AUSTRALIA

No.	Application	OEM - PN	Set	Optibelt AP-Nr.	EAN
2	CUTTERBAR DRIVE, 1STE STAGE	644892.0	1	1001860	4014486488968
3	THRESHING MECHANISM DRIVE	667452.1	1	1001302	4014486492606
4	GRAIN TANK UNLOADING	667250.0	1	1001586	4014486484960
5	CHOPPER DRIVE 1STE STAGE	667958.3	1	1001593	4014486485080
6	SIEVE PAN 2ND STAGE	644902.0	1	1001639	4014486485905
7	CHOPPER DRIVE 2ND STAGE	644890.0	1	1001664	4014486486247
8	CHOPPER DRIVE 3RD STAGE	355658.0	1	1001672	4014486486360
11	SYNCHRONOUS DRIVE	667249.0	1	1003591	4014486484762
12	CUTTERBAR VARIATOR	667530.1	1	1001163	4014486497441
13	CHAFF SPREADER	746508.1	1	1000266	4014486464252
14	CLEANING 3RD STAGE	756466.0	1	1003613	4014486486384
15	CLEANING 1STE STAGE	644209.0	1	1000699	4014486470826
16	HYBRID DRIVE 2ND STAGE	628792.0	1	1001834	4014486488586
17	HYBRID DRIVE 1STE STAGE	644961.0	1	1001930	4014486490008
22	DRUM VARIATOR	667248.0	1	1001317	4014486497908
23	DRUM DRIVE	176442.1	1	1003641	4014486489033
25	FAN DRIVE 1STE STAGE	667957.0	1	1000320	4014486465396
26	SUCTION FAN	667367.0	1	1002582	4014486495638
27	FAN DRIVE 3RD STAGE	744785.0	1	1000326	4014486465525
28	PRE - DRUM DRIVE	667251.1	1	1003601	4014486485219
29	HYDRAULIC REEL DRIVE	829094.0	1	1000245	4014486463712
32	RADIATOR SCREEN 2ND STAGE	545689.0	1	1003332	4014486461886

CLAAS LEXION 580 R AUSTRALIA



35	SUCTION BLOWER E - CHANNEL	765985.0	1	1002287	4014486479706
36	FAN VARIABLE SPEED DRIVE 2ND STAGE	628847.1	1	1001213	4014486497724

CLAAS LEXION 600



No.	Application	OEM - PN	Set	Optibelt AP-Nr.	EAN
1	SUCTION BLOWER E.-CHANNEL	765985.0	1	1002287	4014486479706
5	IMPELLER DRUM DRIVE	667249.0	1	1003591	4014486484762
6	HYDRAULIC REEL PUMP DRIVE	829094.0	1	1000245	4014486463712
7	CUTTERBAR DRIVE - 1ST STAGE B06 / 10 - STANDARD	644892.0	1	1001860	4014486488968
7	CUTTERBAR DRIVE - 1ST STAGE B06 / 20 - VARIATOR	749859.0	1	1001974	4014486490916
8	AT CHAFF-, STRAW- AND RADIAL SPREADER	746508.1	1	1000266	4014486464252
9	THRESHING MECHANISM DRIVE	644884.0	1	1001321	4014486492835
10	DISCHARGE DRIVE GRAIN TANK - 1ST STAGE	667981.2	1	1001588	4014486484991
12	CHOPPER DRIVE - 1ST STAGE	644885.0	1	1001825	4014486488456
13	CHOPPER DRIVE - 2ND STAGE	644889.0	1	1001658	4014486486148
14	CHOPPER DRIVE - 3RD STAGE ONLY FOR RICE	628978.0	1	1001670	4014486486346
18	SIEVE PAN DRIVE - 1ST STAGE	644209.0	1	1000699	4014486470826

CLAAS LEXION 600



19	SIEVE PAN DRIVE - 2ND STAGE	644902.0	1	1001639	4014486485905
21	SIEVE PAN DRIVE 2RD STAGE	756466.0	1	1003613	4014486486384
40	HYBRID DRIVE - 2ND STAGE	628792.0	1	1001834	4014486488586
42	HYBRID DRIVE - 1ST STAGE	749886.1	1	1001928	4014486489972
47	FAN DRIVE - 1ST STAGE	667957.0	1	1000320	4014486465396
49	BLOWER VARIABLE SPEED - 2ND STAGE	628847.1	1	1001213	4014486497724
50	FAN DRIVE - 3RD STAGE	744785.0	1	1000326	4014486465525
53	DRUM DRIVE	644965.0	1	1001864	4014486489040
54	PRE-DRUM DRIVE	667251.1	1	1003601	4014486485219
60	ENGINE	744873.0	1	1001338	4014486483543
63	SUCTION FAN	744874.0	1	1000088	4014486460858

BISO - Schrattecker
 BIZON
 CASE INTL. HARVESTER
 CLAAS
 DEUTZ-FAHR
 DRONNING-BORG
 FENDT
 FORTSCHRITT
 JOHN DEERE
 KRONE
 LAVERDA
 MASSEY FERGUSON
 NEW HOLLAND
 ROSTSELMASH

CLAAS MATADOR - GIGANT

No.	Application	OEM - PN	Set	Optibelt AP-Nr.	EAN
1	TURNING DRUM DRIVE	610197.0	1	1000903	4014486473490
2	TURNING DRUM DRIVE	500863.0	1	1000902	4014486473483
3	COUNTERSHAFT - BALER	551068.0	1	1000925	4014486473759
4	MAIN DRIVE	630144.0	1	1000965	4014486474244
5	RADIATOR FAN DRIVE	610196.0	1	1001029	4014486496284
5	RADIATOR FAN DRIVE	653121.0	1	1001030	4014486496291
5	RADIATOR FAN DRIVE	610835.0	1	1001031	4014486496307
11	SIEVE BOX	772658.0	1	1000935	4014486473865
12	REEL DRIVE VARIABLE SPEED	778561.0	1	1001038	4014486496376
13	PICK UP DRIVE	800309.0	1	1003435	4014486464719
14	DRIVE GRAIN TANK	636021.0	1	1000882	4014486473223
14	DRIVE GRAIN TANK	636021.1	1	1000883	4014486473230
15	TRACTION DRIVE	630156.0	1	1000980	4014486474404
16	DRUM DRIVE VARIABLE SPEED	750294.0	1	1000251	4014486463897
17	STRAW SHAKER	801222.0	4	1002798	4014486465808

CLAAS MATADOR - STANDARD



No.	Application	OEM - PN	Set	Optibelt AP-Nr.	EAN
1	TURNING DRUM DRIVE	610197.0	1	1000903	4014486473490
2	TURNING DRUM DRIVE	500863.0	1	1000902	4014486473483
3	COUNTERSHAFT - BALER	551068.0	1	1000925	4014486473759
4	MAIN DRIVE	630144.0	1	1000965	4014486474244
5	RADIATOR FAN DRIVE	610196.0	1	1001029	4014486496284
5	RADIATOR FAN DRIVE	653121.0	1	1001030	4014486496291
5	RADIATOR FAN DRIVE	610835.0	1	1001031	4014486496307
11	SIEVE BOX	772658.0	1	1000935	4014486473865
12	REEL DRIVE VARIABLE SPEED	778561.0	1	1001038	4014486496376
13	PICK UP DRIVE	800309.0	1	1003435	4014486464719
14	DRIVE GRAIN TANK	636021.0	1	1000882	4014486473223
14	DRIVE GRAIN TANK	636021.1	1	1000883	4014486473230
15	TRACTION DRIVE	630156.0	1	1000980	4014486474404
16	DRUM DRIVE VARIABLE SPEED	750294.0	1	1000251	4014486463897
17	STRAW SHAKER	801222.0	4	1002798	4014486465808

CLAAS MEDION 310



No.	Application	OEM - PN	Set	Optibelt AP-Nr.	EAN
1		644016.1	1	1001800	4014486488104
2		656028.0	1	1003335	4014486462869
3		621903.1	1	1002041	4014486475166
4		660409.0	1	1001575	4014486484809
6		603337.0	1	1000662	4014486470260
7		603336.1	1	1000478	4014486467499
9		623427.1	1	1000409	4014486466720
13		061214.0	1	1000868	4014486473070
13		061353.1	1	1000870	4014486473094
14		671209.0	1	1001039	4014486496383
15		603017.3	2	1000833	4014486472592
19		506671.2	1	1000506	4014486467840
20		545689.0	1	1003332	4014486461886
21		056961.0	1	1000117	4014486461268
22		644448.0	1	1000139	4014486461565
23		609823.0	1	1001225	4014486497809
24		661220.1	1	1003340	4014486488807
26		661429.0	1	1001212	4014486497717

CLAAS MEDION 320



No.	Application	OEM - PN	Set	Optibelt AP-Nr.	EAN
1		644016.1	1	1001800	4014486488104
2		656028.0	1	1003335	4014486462869
3		621903.1	1	1002041	4014486475166
4		660409.0	1	1001575	4014486484809
6		603337.0	1	1000662	4014486470260
7		603336.1	1	1000478	4014486467499
9		623427.1	1	1000409	4014486466720
13		061214.0	1	1000868	4014486473070
13		061353.1	1	1000870	4014486473094
14		671209.0	1	1001039	4014486496383
15		603017.3	2	1000833	4014486472592
19		506671.2	1	1000506	4014486467840
20		545689.0	1	1003332	4014486461886
21		056961.0	1	1000117	4014486461268
22		644448.0	1	1000139	4014486461565
23		609823.0	1	1001225	4014486497809
24		661220.1	1	1003340	4014486488807
26		661429.0	1	1001212	4014486497717

CLAAS MEDION 330



No.	Application	OEM - PN	Set	Optibelt AP-Nr.	EAN
	ALTERNATOR TILL NR. 932002271	545954.0	1	1002646	4014486480849
	ALTERNATOR FROM NO. 93202272	796998.0	1	1003945	4014486481969
1		644016.1	1	1001800	4014486488104
2		656028.0	1	1003335	4014486462869
3		621903.1	1	1002041	4014486475166
4	WITH PERKINS 1006-6 TA	660409.0	1	1001575	4014486484809
4	WITH MERCEDES OM 906 LA	544166.0	1	1003360	4014486484830
5	WITH PERKINS 1006-6 TA	544114.1	1	1001846	4014486488760
5	WITH MERCEDES OM 906 LA	544164.0	1	1001969	4014486490800
6		603337.0	1	1000662	4014486470260
7		603336.1	1	1000478	4014486467499
8		644447.0	1	1000420	4014486466836
9		623427.1	1	1000409	4014486466720
11	N = 660	785341.0	1	1000295	4014486464870
11	N = 519	066034.0	1	1000302	4014486465037
13	FOR CORN	061214.0	1	1000868	4014486473070
13		061353.1	1	1000870	4014486473094
14		671209.0	1	1001039	4014486496383
15		603017.3	2	1000833	4014486472592
17		544147.0	1	1000727	4014486471199
19		506671.2	1	1000506	4014486467840
20	FROM NO. 93202272	821734.2	1	1000154	4014486461763

CLAAS MEDION 330



20	TO NO. 93202271	545689.0	1	1003332	4014486461886
21		056961.0	1	1000117	4014486461268
22		644448.0	1	1000139	4014486461565
23		661427.0	1	1001228	4014486497847
24	DRUM VARIABLE SPEED DRIVE	661220.1	1	1003340	4014486488807
26	DIRECT DRIVE	661429.0	1	1001212	4014486497717

BISO - Schrottecker
 BIZON
 CASE INTL. HARVESTER
 CLAAS
 DEUTZ-FAHR
 DRONNING-BORG
 FENDT
 FORTSCHRITT
 JOHN DEERE
 KRONE
 LAVERDA
 MASSEY FERGUSON
 NEW HOLLAND
 ROSTSELMASH

CLAAS MEDION 330 HYDRO



No.	Application	OEM - PN	Set	Optibelt AP-Nr.	EAN
	ALTERNATOR FROM NR. 93100213	545954.0	1	1002646	4014486480849
	ALTERNATOR FROM NO. 93100214	796998.0	1	1003945	4014486481969
1	HYDRAULIC GROUND DRIVE	644016.1	1	1001800	4014486488104
2	GEAR PUMP	656028.0	1	1003335	4014486462869
3	AIR CONDITIONER	621903.1	1	1002041	4014486475166
4	GRAIN TANK UNLOADING	544166.0	1	1003360	4014486484830
5	THRESHING MECHANISM DRIVE	544164.0	1	1001969	4014486490800
6	SIEVE PAN, 1STE STAGE	603337.0	1	1000662	4014486470260
7	SIEVE PAN, 2ND STAGE	603336.1	1	1000478	4014486467499
8	INTENSIVE SEPARATION SYSTEM	644447.0	1	1000420	4014486466836
13	CHOPPER DRIVE 2ND STAGE	061353.1	1	1000870	4014486473094
14	FAN VARIATOR	671209.0	1	1001039	4014486496383
15	SIEVE PAN, 3RD STAGE	603017.3	2	1000833	4014486472592
17	CHOPPER DRIVE 1STE STAGE	544147.0	1	1000727	4014486471199
19	STRAW WALKER DRIVE	506671.2	1	1000506	4014486467840
20	RADIATOR SCREEN 2ND STAGE FROM NO. 93100144	821734.2	1	1000154	4014486461763
20	RADIATOR SCREEN 2ND STAGE TO NO. 93100143	545689.0	1	1003332	4014486461886
22	RADIATOR SCREEN SUCTION BLOWER	644448.0	1	1000139	4014486461565
26	DIRECT DRIVE DRUM VARIABLE SPEED DRIVE 650 - 1500 RPM	661429.0	1	1001212	4014486497717

CLAAS MEDION 340



No.	Application	OEM - PN	Set	Optibelt AP-Nr.	EAN
2		656028.0	1	1003335	4014486462869
3		621903.1	1	1002041	4014486475166
4		544166.0	1	1003360	4014486484830
5		544164.0	1	1001969	4014486490800
6		603337.0	1	1000662	4014486470260
7		644141.1	1	1000476	4014486467475
9		623427.1	1	1000409	4014486466720
13		061214.0	1	1000868	4014486473070
14		603380.1	1	1001080	4014486498240
15		609762.0	1	1001713	4014486486919
19		506671.2	1	1000506	4014486467840
23		609823.0	1	1001225	4014486497809
24		661220.1	1	1003340	4014486488807

BISO - Schrattecker
 BIZON
 CASE INTL. HARVESTER
 CLAAS
 DEUTZ-FAHR
 DRONNINGBORG
 FENDT
 FORTSCHRITT
 JOHN DEERE
 KRONE
 LAVERDA
 MASSEY FERGUSON
 NEW HOLLAND
 ROSTSELMASH

CLAAS MEGA 202



No.	Application	OEM - PN	Set	Optibelt AP-Nr.	EAN
1	GROUND DRIVE	644465.0	1	1001818	4014486488340
2	HYDRAULIC PUMP	767057.1	1	1003333	4014486462609
3	AIR CONDITIONER	629908.1	1	1002332	4014486478631
5	THRESHING MECHANISM	661458.0	1	1001957	4014486490640
6	GEAR	603337.0	1	1000662	4014486470260
7		603336.1	1	1000478	4014486467499
8	FEED RAKE DRIVE	644447.0	1	1000420	4014486466836
11	AT 3.6M - 5.1M	670224.1	1	1001158	4014486497380
13	FOR CORN PICKER	692149.0	1	1001852	4014486488869
13	FOR CORN PICKER	692150.0	1	1001857	4014486488920
16	AT 6.0M - 6.6M	671013.1	1	1000676	4014486470482
18	AT 3.6M - 5.1M	713506.2	1	1000315	4014486465310
22	FAN	671209.0	1	1001039	4014486496383
23		603017.3	2	1000833	4014486472592

CLAAS MEGA 202



24	STRAW WALKER	506671.2	1	1000506	4014486467840
27	STRAW CHOPPER	060306.2	1	1000723	4014486471151
29	RADIATOR SCREEN	661345.0	1	1000160	4014486461824
30	GEAR	657793.0	1	1000107	4014486461114
32	FOR CORN CHOPPER	061213.0	1	1000860	4014486472943
32	FOR GRAIN CHOPPER	061361.0	1	1000861	4014486472967
33	AT 2 STAGE DRIVE	609823.0	1	1001225	4014486497809
35	AT 6.0M - 6.6M	670224.1	1	1001158	4014486497380
37	SUCTION FAN	644448.0	1	1000139	4014486461565
41	FOR HPH-G CHOPPER	680334.1	1	1001819	4014486488364
43	AT PERKINS 1006.6 T	147233.1	2	1002945	4014486495492
43	AT MERCEDES OM 366 A	133630.1	2	1002961	4014486495058

CLAAS MEGA 202 II



No.	Application	OEM - PN	Set	Optibelt AP-Nr.	EAN
1	GROUND DRIVE	644465.0	1	1001818	4014486488340
2	HYDRAULIC PUMP	767057.1	1	1003333	4014486462609
3	AIR CONDITIONER	629908.1	1	1002332	4014486478631
5	THRESHING MECHANISM	661458.0	1	1001957	4014486490640
6	INTERMEDIATE DRIVE 1	603337.0	1	1000662	4014486470260
7	INTERMEDIATE DRIVE 2	603336.1	1	1000478	4014486467499
8	FEED RAKE DRIVE	644447.0	1	1000420	4014486466836
11	AT 3.6M - 5.1M	670224.1	1	1001158	4014486497380
13	FOR CORN PICKER	692149.0	1	1001852	4014486488869
13	FOR CORN PICKER	692150.0	1	1001857	4014486488920
16	AT 6.0M - 6.6M	671013.1	1	1000676	4014486470482
18	AT 3.6M - 5.1M	713506.2	1	1000315	4014486465310
21	PRE - ACCELERATOR	661031.1	1	1001564	4014486484663
22	FAN	671209.0	1	1001039	4014486496383

CLAAS MEGA 202 II



23	SIEVE PAN / AUGER	603017.3	2	1000833	4014486472592
24	STRAW WALKER	506671.2	1	1000506	4014486467840
29	RADIATOR SCREEN	661345.0	1	1000160	4014486461824
30	GEAR	657793.0	1	1000107	4014486461114
32	FOR CORN - CHOPPER	061213.0	1	1000860	4014486472943
32	FOR GRAIN - CHOPPER	061361.0	1	1000861	4014486472967
33	AT 2 - STAGE DRIVE	609823.0	1	1001225	4014486497809
35	AT 6.0M - 6.6M	670224.1	1	1001158	4014486497380
37	SUCTION FAN	644448.0	1	1000139	4014486461565
41	FOR HPH-G CHOPPER	680334.1	1	1001819	4014486488364
43	AT PERKINS 1006.6 T	147233.1	2	1002945	4014486495492
43	AT MERCEDES OM 366A	133630.1	2	1002961	4014486495058

CLAAS MEGA 203

No.	Application	OEM - PN	Set	Optibelt AP-Nr.	EAN
1	GROUND DRIVE	661362.1	1	1001951	4014486490565
1	AT MERCEDES OM 366 LA WITH 163 KW	661451.0	1	1001958	4014486490664
2	HYDRAULIC PUMP	767057.1	1	1003333	4014486462609
3	AIR CONDITIONER	629908.1	1	1002332	4014486478631
4	AT MERCEDES OM 366 LA WITH 163 KW	660409.0	1	1001575	4014486484809
5	THRESHING MECHANISM	661458.0	1	1001957	4014486490640
5	AT MERCEDES OM 366 LA WITH 163 KW	644404.1	1	1003354	4014486490763
6	GEAR	603337.0	1	1000662	4014486470260
7		644141.1	1	1000476	4014486467475
7		603336.1	1	1000478	4014486467499
8	FEED RAKE DRIVE	644447.0	1	1000420	4014486466836
11	AT 3.9M - 5.1M	670224.1	1	1001158	4014486497380
13	FOR CORN PICKER	692149.0	1	1001852	4014486488869
13	FOR CORN PICKER	692150.0	1	1001857	4014486488920
13	FOR MULTIMASTER	629142.0	1	1001954	4014486490596
16	AT 6.0M - 7.5M	671013.1	1	1000676	4014486470482
18	AT 3.9M - 5.1M	713506.2	1	1000315	4014486465310
22	BLOWER - 203 MEGA	671209.0	1	1001039	4014486496383
22	BLOWER - 204 MEGA	603380.1	1	1001080	4014486498240
23	SIEVE PAN	603017.3	2	1000833	4014486472592
23	SIEVE PAN	609762.0	1	1001713	4014486486919
24	STRAW WALKER	506671.2	1	1000506	4014486467840

CLAAS MEGA 203, 203 II



25	STRAW SPREADER	623427.1	1	1000409	4014486466720
27	STRAW CHOPPER	060306.2	1	1000723	4014486471151
29	RADIATOR SCREEN	661345.0	1	1000160	4014486461824
30	GEAR	657793.0	1	1000107	4014486461114
32	FOR CORN CHOPPER	061214.0	1	1000868	4014486473070
32	TO NO. 09350551	061360.0	1	1000870	4014486473094
33	AT 2 STAGE DRIVE	609823.0	1	1001225	4014486497809
35	AT 6.0M - 7.5M	670224.1	1	1001158	4014486497380
37	SUCTION FAN	644448.0	1	1000139	4014486461565
41	FOR HPH - G CHOPPER	680334.1	1	1001819	4014486488364
43	AT PERKINS 1006.6 T	147233.1	2	1002945	4014486495492
43	AT MERCEDES OM 366 LA	133635.1	2	1002958	4014486495782
43	AT MERCEDES OM 366 A	133630.1	2	1002961	4014486495058
1	WITH MERCEDES OM 906 LA	644016.1	1	1001800	4014486488104
1	GROUND DRIVE	661362.1	1	1001951	4014486490565
1	AT MERCEDES OM 366 LA WITH 163 KW	661451.0	1	1001958	4014486490664
2	HYDRAULIC PUMP	767057.1	1	1003333	4014486462609
2	HYDRAULIC PUMP WITH MERCEDES OM 906 LA	656028.0	1	1003335	4014486462869
3	AIR CONDITIONING WITH MERCEDES OM 906 LA	621903.1	1	1002041	4014486475166
3	AIR CONDITIONER	629908.1	1	1002332	4014486478631
4	AT MERCEDES OM 366 LA WITH 163 KW	660409.0	1	1001575	4014486484809

CLAAS MEGA 203 II

No.	Application	OEM - PN	Set	Optibelt AP-Nr.	EAN
4	GRAIN TANK	629769.1	1	1002699	4014486484922
4	WITH MERD	544166.0	1	1003360	4014486484830
5	THRESHING MECHANISM	661458.0	1	1001957	4014486490640
5	WITH MERCEDES OM 906 LA	544164.0	1	1001969	4014486490800
5	AT MERCEDES OM 366 LA WITH 163 KW	644404.1	1	1003354	4014486490763
6	GEAR	603337.0	1	1000662	4014486470260
7		603336.1	1	1000478	4014486467499
8	FEED RAKE DRIVE	644447.0	1	1000420	4014486466836
11	AT 3.9M - 5.1M	670224.1	1	1001158	4014486497380
13	FOR CORN PICKER	692149.0	1	1001852	4014486488869
13	FOR CORN PICKER	692150.0	1	1001857	4014486488920
13	FOR MULTIMASTER	661362.1	1	1001951	4014486490565
16	AT 6.0M - 7.5M	671013.1	1	1000676	4014486470482
18	AT 3.9M - 5.1M	713506.2	1	1000315	4014486465310
21	PRE - ACCELERATOR	661031.1	1	1001564	4014486484663
22	BLOWER - 203 MEGA	671209.0	1	1001039	4014486496383
23	SIEVE PAN	603017.3	2	1000833	4014486472592
24	STRAW WALKER	506671.2	1	1000506	4014486467840
25	STRAW SPREADER	623427.1	1	1000409	4014486466720
29	RADIATOR SCREEN WITH MERCEDES OM 906 LA	545668.1	1	1000119	4014486461305
29	RADIATOR SCREEN	661345.0	1	1000160	4014486461824
30	MERCEDES OM 366 LA	657793.0	1	1000107	4014486461114

CLAAS MEGA 203 II



30	PERKINS 1006.6 T	657793.0	1	1000107	4014486461114
30	MERCEDES OM 366 LA 163 KW	661244.0	1	1000125	4014486461374
30	WITH MERCEDES OM 906 LA	545689.0	1	1003332	4014486461886
32	FOR CORN - CHOPPER	061214.0	1	1000868	4014486473070
32	GRAIN	061353.1	1	1000870	4014486473094
33	AT DOMINATOR 204 MEGA WITH N = 650 - 1500 MIN-1	609823.0	1	1001225	4014486497809
33	AT 2 STAGE DRIVE	609823.0	1	1001225	4014486497809
34	AT DOMINATOR 204 MEGA WITH N = 650 - 1500 MIN-1	661220.1	1	1003340	4014486488807
34	AT 2 STAGE DRIVE	661220.1	1	1003340	4014486488807
35	AT 6.0M - 7.5M	670224.1	1	1001158	4014486497380
37	SUCTION FAN	644448.0	1	1000139	4014486461565
41	FOR HPH - G CHOPPER	680334.1	1	1001819	4014486488364
43	AT PERKINS 1006.6 T	147233.1	2	1002945	4014486495492
43	MERCEDES 366 LA (147 KW)	133635.1	2	1002958	4014486495782
43	MERCEDES 366 LA (163 KW)	133642.0	2	1003772	4014486495737

CLAAS MEGA 204

No.	Application	OEM - PN	Set	Optibelt AP-Nr.	EAN
1	GROUND DRIVE	661362.1	1	1001951	4014486490565
1	AT MERCEDES OM 366 LA WITH 163 KW	661451.0	1	1001958	4014486490664
2	HYDRAULIC PUMP	767057.1	1	1003333	4014486462609
3	AIR CONDITIONER	629908.1	1	1002332	4014486478631
4	AT MERCEDES OM 366 LA WITH 163 KW	660409.0	1	1001575	4014486484809
5	THRESHING MECHANISM	661458.0	1	1001957	4014486490640
5	AT MERCEDES OM 366 LA WITH 163 KW	644404.1	1	1003354	4014486490763
6	GEAR	603337.0	1	1000662	4014486470260
7	GRAIN ELEVATOR - 204 MEGA FROM NO. 09350930	644141.1	1	1000476	4014486467475
8	FEED RAKE DRIVE	644447.0	1	1000420	4014486466836
11	AT 3.9M - 5.1M	670224.1	1	1001158	4014486497380
13	FOR CORN PICKER	692149.0	1	1001852	4014486488869
13	FOR CORN PICKER	692150.0	1	1001857	4014486488920
13	FOR MULTIMASTER	629142.0	1	1001954	4014486490596
16	AT 6.0M - 7.5M	671013.1	1	1000676	4014486470482
18	AT 3.9M - 5.1M	713506.2	1	1000315	4014486465310
22	BLOWER - 204 MEGA	603380.1	1	1001080	4014486498240
23	SIEVE PAN	609762.0	1	1001713	4014486486919
24	STRAW WALKER	506671.2	1	1000506	4014486467840
25	STRAW SPREADER	623427.1	1	1000409	4014486466720
27	STRAW CHOPPER	060306.2	1	1000723	4014486471151
29	RADIATOR SCREEN	661345.0	1	1000160	4014486461824

CLAAS MEGA 204, 204 II



30	GEAR	657793.0	1	1000107	4014486461114
32	FOR CORN CHOPPER	061214.0	1	1000868	4014486473070
32	TO NO. 09350551	061360.0	1	1000870	4014486473094
33	AT DOMINATOR 204 MEGA WITH N = 650 - 1500 MIN-1	609823.0	1	1001225	4014486497809
33	AT 2 STAGE DRIVE	609823.0	1	1001225	4014486497809
35	AT 6.0M - 7.5M	670224.1	1	1001158	4014486497380
37	SUCTION FAN	644448.0	1	1000139	4014486461565
41	FOR HPH - G CHOPPER	680334.1	1	1001819	4014486488364
43	AT PERKINS 1006.6 T	147233.1	2	1002945	4014486495492
43	AT MERCEDES OM 366 LA	133635.1	2	1002958	4014486495782
43	AT MERCEDES OM 366 A	133630.1	2	1002961	4014486495058
1	WITH MERCEDES OM 906 LA	644016.1	1	1001800	4014486488104
1	GROUND DRIVE	661362.1	1	1001951	4014486490565
1	AT MERCEDES OM 366 LA WITH 163 KW	661451.0	1	1001958	4014486490664
2	HYDRAULIC PUMP	767057.1	1	1003333	4014486462609
2	HYDRAULIC PUMP WITH MERCEDES OM 906 LA	656028.0	1	1003335	4014486462869
3	AIR CONDITIONING WITH MERCEDES OM 906 LA	621903.1	1	1002041	4014486475166
3	AIR CONDITIONER	629908.1	1	1002332	4014486478631
4	AT MERCEDES OM 366 LA WITH 163 KW	660409.0	1	1001575	4014486484809
4	GRAIN TANK	629769.1	1	1002699	4014486484922
4	WITH MERD	544166.0	1	1003360	4014486484830

CLAAS MEGA 204 II

No.	Application	OEM - PN	Set	Optibelt AP-Nr.	EAN
5	THRESHING MECHANISM	661458.0	1	1001957	4014486490640
5	WITH MERCEDES OM 906 LA	544164.0	1	1001969	4014486490800
5	AT MERCEDES OM 366 LA WITH 163 KW	644404.1	1	1003354	4014486490763
6	GEAR	603337.0	1	1000662	4014486470260
7		644141.1	1	1000476	4014486467475
8	FEED RAKE DRIVE	644447.0	1	1000420	4014486466836
11	AT 3.9M - 5.1M	670224.1	1	1001158	4014486497380
13	FOR CORN PICKER	692149.0	1	1001852	4014486488869
13	FOR CORN PICKER	692150.0	1	1001857	4014486488920
13	FOR MULTIMASTER	661362.1	1	1001951	4014486490565
16	AT 6.0M - 7.5M	671013.1	1	1000676	4014486470482
18	AT 3.9M - 5.1M	713506.2	1	1000315	4014486465310
21	PRE - ACCELERATOR	661031.1	1	1001564	4014486484663
22	BLOWER - 204 MEGA	603380.1	1	1001080	4014486498240
23	SIEVE PAN	609762.0	1	1001713	4014486486919
24	STRAW WALKER	506671.2	1	1000506	4014486467840
25	STRAW SPREADER	623427.1	1	1000409	4014486466720
27	STRAW CHOPPER	644538.0	1	1001655	4014486486094
29	RADIATOR SCREEN WITH MERCEDES OM 906 LA	545668.1	1	1000119	4014486461305
29	RADIATOR SCREEN	661345.0	1	1000160	4014486461824
30	MERCEDES OM 366 LA	657793.0	1	1000107	4014486461114
30	PERKINS 1006.6 T	657793.0	1	1000107	4014486461114

CLAAS MEGA 204 II



30	MERCEDES OM 366 LA 163 KW	661244.0	1	1000125	4014486461374
30	WITH MERCEDES OM 906 LA	545689.0	1	1003332	4014486461886
32	FOR CORN - CHOPPER	061214.0	1	1000868	4014486473070
32	GRAIN	061353.1	1	1000870	4014486473094
32	GRAIN	644539.0	1	1000871	4014486473100
33	AT DOMINATOR 204 MEGA WITH N = 650 - 1500 MIN-1	609823.0	1	1001225	4014486497809
33	AT 2 STAGE DRIVE	609823.0	1	1001225	4014486497809
34	AT DOMINATOR 204 MEGA WITH N = 650 - 1500 MIN-1	661220.1	1	1003340	4014486488807
34	AT 2 STAGE DRIVE	661220.1	1	1003340	4014486488807
35	AT 6.0M - 7.5M	670224.1	1	1001158	4014486497380
37	SUCTION FAN	644448.0	1	1000139	4014486461565
41	FOR HPH - G CHOPPER	680334.1	1	1001819	4014486488364
43	AT PERKINS 1006.6 T	147233.1	2	1002945	4014486495492
43	MERCEDES 366 LA (147 KW)	133635.1	2	1002958	4014486495782
43	MERCEDES 366 LA (163 KW)	133642.0	2	1003772	4014486495737

CLAAS MEGA 208

No.	Application	OEM - PN	Set	Optibelt AP-Nr.	EAN
1	OM 441 A GROUND DRIVE	661239.1	1	1001244	4014486491999
1	OM 366 LA GROUND DRIVE	661451.0	1	1001958	4014486490664
2	OM 441 A HYDRAULIC PUMP	633030.2	1	1000220	4014486462838
2	OM 366 LA HYDRAULIC PUMP	767057.1	1	1003333	4014486462609
3	OM 366 LA AIR CONDITIONING	629908.1	1	1002332	4014486478631
3	OM 441 A AIR CONDITIONING	661114.0	1	1002336	4014486478686
4	OM 366 LA GRAIN TANK	660409.0	1	1001575	4014486484809
4	OM 441 A GRAIN TANK	661093.0	1	1001581	4014486484885
5	OM 441 A THRESHING MECHANISM	644403.0	1	1001247	4014486492033
5	OM 366 LA THRESHING MECHANISM	644404.1	1	1003354	4014486490763
6	GEAR	603337.0	1	1000662	4014486470260
7		644141.1	1	1000476	4014486467475
8	FEED RAKE DRIVE	644447.0	1	1000420	4014486466836
11	AT 4.5M - 5.1M	670224.1	1	1001158	4014486497380
13	FOR CORN PICKER	692149.0	1	1001852	4014486488869
13	FOR CORN PICKER	692150.0	1	1001857	4014486488920
13	FOR MULTIMASTER	629142.0	1	1001954	4014486490596
16	AT 6.0M - 9.0M	671013.1	1	1000676	4014486470482
18	AT 4.5M - 5.1M	713506.2	1	1000315	4014486465310
20	SHAFTS DISTANCE 1463MM	644399.0	1	1000855	4014486472882
22	FAN	603380.1	1	1001080	4014486498240
23	SIEVE BOX	609762.0	1	1001713	4014486486919

CLAAS MEGA 208



24	STRAW WALKER	506671.2	1	1000506	4014486467840
25	STRAW SPREADER	623427.1	1	1000409	4014486466720
30	RADIATOR SCREEN	661345.0	1	1000160	4014486461824
31	OM 366 LA INTERMEDIATE DRIVE	661244.0	1	1000125	4014486461374
31	OM 441 A INTERMEDIATE DRIVE	661245.0	1	1003377	4014486461435
33	FOR CORN CHOPPER	061214.0	1	1000868	4014486473070
33	FOR GRAIN CHOPPER	061353.1	1	1000870	4014486473094
34	DRUM GEAR	609823.0	1	1001225	4014486497809
35	AT N 510 - 1400 MIN-1	661298.0	1	1001630	4014486485738
36	AT 6.0M - 9.0M	670224.1	1	1001158	4014486497380
41	FOR HPH - G CHOPPER	680334.1	1	1001819	4014486488364
42	FOR SUCTION BLOWER	644448.0	1	1000139	4014486461565

CLAAS MEGA 208 II

No.	Application	OEM - PN	Set	Optibelt AP-Nr.	EAN
1	OM 441 A GROUND DRIVE	661239.1	1	1001244	4014486491999
1	OM 366 LA GROUND DRIVE	661451.0	1	1001958	4014486490664
2	OM 441 A HYDRAULIC PUMP	633030.2	1	1000220	4014486462838
2	OM 366 LA HYDRAULIC PUMP	767057.1	1	1003333	4014486462609
3	OM 366 LA AIR CONDITIONING	629908.1	1	1002332	4014486478631
3	OM 441 A AIR CONDITIONING	661114.0	1	1002336	4014486478686
4	OM 366 LA GRAIN TANK	660409.0	1	1001575	4014486484809
4	OM 441 A GRAIN TANK	661093.0	1	1001581	4014486484885
5	OM 441 A THRESHING MECHANISM	644403.0	1	1001247	4014486492033
5	OM 366 LA THRESHING MECHANISM	644404.1	1	1003354	4014486490763
6	GEAR	603337.0	1	1000662	4014486470260
7		644141.1	1	1000476	4014486467475
8	FEED RAKE DRIVE	644447.0	1	1000420	4014486466836
11	AT 4.5M - 5.1M	670224.1	1	1001158	4014486497380
13	FOR CORN PICKER	692149.0	1	1001852	4014486488869
13	FOR CORN PICKER	692150.0	1	1001857	4014486488920
13	FOR MULTIMASTER	629142.0	1	1001954	4014486490596
16	AT 6.0M - 9M	671013.1	1	1000676	4014486470482
18	AT 4.5M - 5.1M	713506.2	1	1000315	4014486465310
21	ACCELERATOR	661031.1	1	1001564	4014486484663
22	FAN	603380.1	1	1001080	4014486498240
23	SIEVE BOX	609762.0	1	1001713	4014486486919

CLAAS MEGA 208 II



24	STRAW WALKER	506671.2	1	1000506	4014486467840
25	STRAW SPREADER	623427.1	1	1000409	4014486466720
27	STRAW CHOPPER FROM NO. 94501059	644538.0	1	1001655	4014486486094
30	RADIATOR SCREEN	661345.0	1	1000160	4014486461824
31	OM 366 LA INTERMEDIATE DRIVE	661244.0	1	1000125	4014486461374
31	OM 441 A INTERMEDIATE DRIVE	661245.0	1	1003377	4014486461435
33	FOR CORN CHOPPER	061214.0	1	1000868	4014486473070
33	FOR GRAIN CHOPPER TO NO. 94501058	061353.1	1	1000870	4014486473094
33	FOR GRAIN CHOPPER FROM NO. 94501059	644539.0	1	1000871	4014486473100
34	DRUM GEAR	609823.0	1	1001225	4014486497809
35	DRUM DRIVE	661220.1	1	1003340	4014486488807
36	AT 6.0M - 9M	670224.1	1	1001158	4014486497380
41	FOR HPH - G CHOPPER	680334.1	1	1001819	4014486488364
42	TO NO. 94501058	644448.0	1	1000139	4014486461565
42	FOR SUCTION BLOWER FROM NO. 94501059	644537.0	1	1000140	4014486461572

CLAAS MEGA 218

No.	Application	OEM - PN	Set	Optibelt AP-Nr.	EAN
1	OM 441 A GROUND DRIVE	661239.1	1	1001244	4014486491999
1	OM 366 LA GROUND DRIVE	661451.0	1	1001958	4014486490664
2	OM 441 A HYDRAULIC PUMP	633030.2	1	1000220	4014486462838
2	OM 366 LA HYDRAULIC PUMP	767057.1	1	1003333	4014486462609
3	OM 366 LA AIR CONDITIONING	629908.1	1	1002332	4014486478631
3	OM 441 A AIR CONDITIONING	661114.0	1	1002336	4014486478686
4	OM 366 LA GRAIN TANK	660409.0	1	1001575	4014486484809
4	OM 441 A GRAIN TANK	661093.0	1	1001581	4014486484885
5	OM 441 A THRESHING MECHANISM	644403.0	1	1001247	4014486492033
5	OM 366 LA THRESHING MECHANISM	644404.1	1	1003354	4014486490763
6	GEAR	603337.0	1	1000662	4014486470260
7		644141.1	1	1000476	4014486467475
8	FEED RAKE DRIVE	644447.0	1	1000420	4014486466836
11	AT 4.5M - 5.1M	670224.1	1	1001158	4014486497380
13	FOR CORN PICKER	692149.0	1	1001852	4014486488869
13	FOR CORN PICKER	692150.0	1	1001857	4014486488920
13	FOR MULTIMASTER	629142.0	1	1001954	4014486490596
16	AT 6.0M - 9.0M	671013.1	1	1000676	4014486470482
18	AT 4.5M - 5.1M	713506.2	1	1000315	4014486465310
20	SHAFTS DISTANCE 1463MM	644399.0	1	1000855	4014486472882
22	FAN	603380.1	1	1001080	4014486498240
23	SIEVE BOX	609762.0	1	1001713	4014486486919

CLAAS MEGA 218



24	STRAW WALKER	506671.2	1	1000506	4014486467840
25	STRAW SPREADER	623427.1	1	1000409	4014486466720
30	RADIATOR SCREEN	661345.0	1	1000160	4014486461824
31	OM 366 LA INTERMEDIATE DRIVE	661244.0	1	1000125	4014486461374
31	OM 441 A INTERMEDIATE DRIVE	661245.0	1	1003377	4014486461435
33	FOR CORN CHOPPER	061214.0	1	1000868	4014486473070
33	FOR GRAIN CHOPPER	061353.1	1	1000870	4014486473094
34	DRUM GEAR	609823.0	1	1001225	4014486497809
35	AT N 510 - 1400 MIN-1	661298.0	1	1001630	4014486485738
36	AT 6.0M - 9.0M	670224.1	1	1001158	4014486497380
41	FOR HPH - G CHOPPER	680334.1	1	1001819	4014486488364
42	FOR SUCTION BLOWER	644448.0	1	1000139	4014486461565

BISO - Schrattecker
 BIZON
 CASE INTL. HARVESTER
 CLAAS
 DEUTZ-FAHR
 DRONNING-BORG
 FENDT
 FORTSCHRITT
 JOHN DEERE
 KRONE
 LAVERDA
 MASSEY FERGUSON
 NEW HOLLAND
 ROSTSELMASH

CLAAS MEGA 218 II

No.	Application	OEM - PN	Set	Optibelt AP-Nr.	EAN
1	OM 441 A GROUND DRIVE	661239.1	1	1001244	4014486491999
1	OM 366 LA GROUND DRIVE	661451.0	1	1001958	4014486490664
2	OM 441 A HYDRAULIC PUMP	633030.2	1	1000220	4014486462838
2	OM 366 LA HYDRAULIC PUMP	767057.1	1	1003333	4014486462609
3	OM 366 LA AIR CONDITIONING	629908.1	1	1002332	4014486478631
3	OM 441 A AIR CONDITIONING	661114.0	1	1002336	4014486478686
4	OM 366 LA GRAIN TANK	660409.0	1	1001575	4014486484809
4	OM 441 A GRAIN TANK	661093.0	1	1001581	4014486484885
5	OM 441 A THRESHING MECHANISM	644403.0	1	1001247	4014486492033
5	OM 366 LA THRESHING MECHANISM	644404.1	1	1003354	4014486490763
6	GEAR	603337.0	1	1000662	4014486470260
7		644141.1	1	1000476	4014486467475
8	FEED RAKE DRIVE	644447.0	1	1000420	4014486466836
11	AT 4.5M - 5.1M	670224.1	1	1001158	4014486497380
13	FOR CORN PICKER	692149.0	1	1001852	4014486488869
13	FOR CORN PICKER	692150.0	1	1001857	4014486488920
13	FOR MULTIMASTER	629142.0	1	1001954	4014486490596
16	AT 6.0M - 9M	671013.1	1	1000676	4014486470482
18	AT 4.5M - 5.1M	713506.2	1	1000315	4014486465310
21	ACCELERATOR	661031.1	1	1001564	4014486484663
22	FAN	603380.1	1	1001080	4014486498240
23	SIEVE BOX	609762.0	1	1001713	4014486486919

CLAAS MEGA 218 II



24	STRAW WALKER	506671.2	1	1000506	4014486467840
25	STRAW SPREADER	623427.1	1	1000409	4014486466720
27	STRAW CHOPPER FROM NO. 94501059	644538.0	1	1001655	4014486486094
30	RADIATOR SCREEN	661345.0	1	1000160	4014486461824
31	OM 366 LA INTERMEDIATE DRIVE	661244.0	1	1000125	4014486461374
31	OM 441 A INTERMEDIATE DRIVE	661245.0	1	1003377	4014486461435
33	FOR CORN CHOPPER	061214.0	1	1000868	4014486473070
33	FOR GRAIN CHOPPER TO NO. 94501058	061353.1	1	1000870	4014486473094
33	FOR GRAIN CHOPPER FROM NO. 94501059	644539.0	1	1000871	4014486473100
34	DRUM GEAR	609823.0	1	1001225	4014486497809
35	DRUM DRIVE	661220.1	1	1003340	4014486488807
36	AT 6.0M - 9M	670224.1	1	1001158	4014486497380
41	FOR HPH - G CHOPPER	680334.1	1	1001819	4014486488364
42	TO NO. 94501058	644448.0	1	1000139	4014486461565
42	FOR SUCTION BLOWER FROM NO. 94501059	644537.0	1	1000140	4014486461572

CLAAS MEGA 350



No.	Application	OEM - PN	Set	Optibelt AP-Nr.	EAN
1		644016.1	1	1001800	4014486488104
2		656028.0	1	1003335	4014486462869
2	FOR THRESHING	629002.1	1	1003395	4014486462715
3		621903.1	1	1002041	4014486475166
4		544166.0	1	1003360	4014486484830
5		544164.0	1	1001969	4014486490800
6		603337.0	1	1000662	4014486470260
6	FOR THRESHING	667238.0	1	1000693	4014486470741
7		644141.1	1	1000476	4014486467475
8		644447.0	1	1000420	4014486466836
9		623427.1	1	1000409	4014486466720
11	FOR N=660 RPM	785341.0	1	1000295	4014486464870

CLAAS MEGA 350



11	FOR N=519 RPM	066034.0	1	1000302	4014486465037
13		644539.0	1	1000871	4014486473100
14		603380.1	1	1001080	4014486498240
15		609762.0	1	1001713	4014486486919
17		644538.0	1	1001655	4014486486094
19		506671.2	1	1000506	4014486467840
20		545689.0	1	1003332	4014486461886
21		545668.1	1	1000119	4014486461305
22		644537.0	1	1000140	4014486461572
23	TWO STAGE DRIVE	661427.0	1	1001228	4014486497847
24	DRUM DRIVE VARIABLE SPEED (N=650-1500 RPM)	661220.1	1	1003340	4014486488807

CLAAS MEGA 350 TYP 835

No.	Application	OEM - PN	Set	Optibelt AP-Nr.	EAN
	ALTERNATOR FROM NR. 83500255	545954.0	1	1002646	4014486480849
	ALTERNATOR FROM NO. 83500256	796998.0	1	1003945	4014486481969
1		644016.1	1	1001800	4014486488104
2		656028.0	1	1003335	4014486462869
2	WHEN THRESHING	629002.1	1	1003395	4014486462715
3		621903.1	1	1002041	4014486475166
4		544166.0	1	1003360	4014486484830
5		544164.0	1	1001969	4014486490800
6		603337.0	1	1000662	4014486470260
6	WHEN THRESHING	667238.0	1	1000693	4014486470741
7		644141.1	1	1000476	4014486467475
8		644447.0	1	1000420	4014486466836
9		623427.1	1	1000409	4014486466720
11	N = 660	785341.0	1	1000295	4014486464870
11	N = 519	066034.0	1	1000302	4014486465037
13		544172.0	1	1001745	4014486487299
14		603380.1	1	1001080	4014486498240
15		609762.0	1	1001713	4014486486919
17		644538.0	1	1001655	4014486486094
19		506671.2	1	1000506	4014486467840
20	FROM NO. 83500256	821734.2	1	1000154	4014486461763
20	TO NO. 83500255	545689.0	1	1003332	4014486461886

CLAAS MEGA 350 TYP 835, 350 TYP 836



21	TO NO. 83500255	545668.1	1	1000119	4014486461305
22		644537.0	1	1000140	4014486461572
23	TWO STAGE DRIVE	661427.0	1	1001228	4014486497847
24	DRUM VARIABLE SPEED N = 650 - 1500	661220.1	1	1003340	4014486488807
	ALTERNATOR FROM NR. 83500255	545954.0	1	1002646	4014486480849
	ALTERNATOR FROM NO. 83500256	796998.0	1	1003945	4014486481969
1		644016.1	1	1001800	4014486488104
2		656028.0	1	1003335	4014486462869
2	WHEN THRESHING	629002.1	1	1003395	4014486462715
3		621903.1	1	1002041	4014486475166
4		544166.0	1	1003360	4014486484830
5		544164.0	1	1001969	4014486490800
6		603337.0	1	1000662	4014486470260
6	WHEN THRESHING	667238.0	1	1000693	4014486470741
7		644141.1	1	1000476	4014486467475
8		644447.0	1	1000420	4014486466836
9		623427.1	1	1000409	4014486466720
11	N = 660	785341.0	1	1000295	4014486464870
11	N = 519	066034.0	1	1000302	4014486465037
13		544172.0	1	1001745	4014486487299
14		603380.1	1	1001080	4014486498240

CLAAS MEGA 350 TYP 836, 360



No.	Application	OEM - PN	Set	Optibelt AP-Nr.	EAN
15		609762.0	1	1001713	4014486486919
17		644538.0	1	1001655	4014486486094
19		506671.2	1	1000506	4014486467840
20	FROM NO. 83500256	821734.2	1	1000154	4014486461763
20	TO NO. 83500255	545689.0	1	1003332	4014486461886
21	TO NO. 83500255	545668.1	1	1000119	4014486461305
22		644537.0	1	1000140	4014486461572
23	TWO STAGE DRIVE	661427.0	1	1001228	4014486497847
24	DRUM VARIABLE SPEED DRIVE N = 650 - 1500	661220.1	1	1003340	4014486488807
	ALTERNATOR DRIVE (TILL NR. 84500261)	545954.0	1	1002646	4014486480849
	ALTERNATOR DRIVE (FROM NR. 84500262)	796998.0	1	1003945	4014486481969
1		544049.1	2	1001561	4014486484618
2		656028.0	1	1003335	4014486462869
2		629002.1	1	1003395	4014486462715
3		621903.1	1	1002041	4014486475166
4		544166.0	1	1003360	4014486484830
5		544164.0	1	1001969	4014486490800
6		603337.0	1	1000662	4014486470260
6		667238.0	1	1000693	4014486470741
7		644141.1	1	1000476	4014486467475
8		644447.0	1	1000420	4014486466836

CLAAS MEGA 360



9		623427.1	1	1000409	4014486466720
11		785341.0	1	1000295	4014486464870
11		066034.0	1	1000302	4014486465037
13		544172.0	1	1001745	4014486487299
14		603380.1	1	1001080	4014486498240
15		609762.0	1	1001713	4014486486919
17		644538.0	1	1001655	4014486486094
19		506671.2	1	1000506	4014486467840
20	FROM NR. 84500262	821734.2	1	1000154	4014486461763
20	TO NR. 84500261	545689.0	1	1003332	4014486461886
21	TO NR. 84500261	545668.1	1	1000119	4014486461305
22		644537.0	1	1000140	4014486461572
23	TO NR. 84500386 HIGH - LOW SPEED	609823.0	1	1001225	4014486497809
23	FROM NR. 84500387	661427.0	1	1001228	4014486497847
24	DRUM DRIVE VARIABLE SPEED (N=650-1500 RPM)	661220.1	1	1003340	4014486488807

CLAAS MEGA 360 TYP 845

No.	Application	OEM - PN	Set	Optibelt AP-Nr.	EAN
	ALTERNATOR FROM NR. 84500261	545954.0	1	1002646	4014486480849
	ALTERNATOR FROM NO. 84500262	796998.0	1	1003945	4014486481969
1	1 SET = 2 BELTS	544049.1	2	1001561	4014486484618
2		656028.0	1	1003335	4014486462869
2	WHEN THRESHING	629002.1	1	1003395	4014486462715
3		621903.1	1	1002041	4014486475166
4		544166.0	1	1003360	4014486484830
5		544164.0	1	1001969	4014486490800
6		603337.0	1	1000662	4014486470260
6	WHEN THRESHING	667238.0	1	1000693	4014486470741
7		644141.1	1	1000476	4014486467475
8		644447.0	1	1000420	4014486466836
9		623427.1	1	1000409	4014486466720
11	N = 660	785341.0	1	1000295	4014486464870
11	N = 519	066034.0	1	1000302	4014486465037
13		544172.0	1	1001745	4014486487299
14		603380.1	1	1001080	4014486498240
15		609762.0	1	1001713	4014486486919
17		644538.0	1	1001655	4014486486094
19		506671.2	1	1000506	4014486467840
20	FROM NO. 84500262	821734.2	1	1000154	4014486461763
20	TO NO. 84500261	545689.0	1	1003332	4014486461886

CLAAS MEGA 360 TYP 845, 360 TYP 846



21	TO NO. 84500261	545668.1	1	1000119	4014486461305
22		644537.0	1	1000140	4014486461572
23	TO NO. 84500386 HIGH - LOW SPEED RANGE TRANSMISSION	609823.0	1	1001225	4014486497809
23	FROM NO. 84500387	661427.0	1	1001228	4014486497847
24	DRUM VARIABLE SPEED DRIVE N = 650 - 1500	661220.1	1	1003340	4014486488807
	ALTERNATOR FROM NR. 84500261	545954.0	1	1002646	4014486480849
	ALTERNATOR FROM NO. 84500262	796998.0	1	1003945	4014486481969
1	1 SET = 2 BELTS	544049.1	2	1001561	4014486484618
2		656028.0	1	1003335	4014486462869
2	WHEN THRESHING	629002.1	1	1003395	4014486462715
3		621903.1	1	1002041	4014486475166
4		544166.0	1	1003360	4014486484830
5		544164.0	1	1001969	4014486490800
6		603337.0	1	1000662	4014486470260
6	WHEN THRESHING	667238.0	1	1000693	4014486470741
7		644141.1	1	1000476	4014486467475
8		644447.0	1	1000420	4014486466836
9		623427.1	1	1000409	4014486466720
11		785341.0	1	1000295	4014486464870
11	N = 519	066034.0	1	1000302	4014486465037
13		544172.0	1	1001745	4014486487299

CLAAS MEGA 360 TYP 846, 360 TYP C12

No.	Application	OEM - PN	Set	Optibelt AP-Nr.	EAN
14		603380.1	1	1001080	4014486498240
15		609762.0	1	1001713	4014486486919
17		644538.0	1	1001655	4014486486094
19		506671.2	1	1000506	4014486467840
20	FROM NO. 84500262	821734.2	1	1000154	4014486461763
20	TO NO. 84500261	545689.0	1	1003332	4014486461886
21	TO NO. 84500261	545668.1	1	1000119	4014486461305
22		644537.0	1	1000140	4014486461572
23	TO NO. 84500386 HIGH - LOW SPEED RANGE TRANSMISSION	609823.0	1	1001225	4014486497809
23	FROM NO. 84500387	661427.0	1	1001228	4014486497847
24	DRUM VARIABLE SPEED DRIVE N = 650 - 1500	661220.1	1	1003340	4014486488807
	ALTERNATOR FROM NR. 84500261	545954.0	1	1002646	4014486480849
	ALTERNATOR FROM NO. 84500262	796998.0	1	1003945	4014486481969
1	1 SET = 2 BELTS	544049.1	2	1001561	4014486484618
2		656028.0	1	1003335	4014486462869
2	WHEN THRESHING	629002.1	1	1003395	4014486462715
3		621903.1	1	1002041	4014486475166
4		544166.0	1	1003360	4014486484830
5		544164.0	1	1001969	4014486490800
6		603337.0	1	1000662	4014486470260
6	WHEN THRESHING	667238.0	1	1000693	4014486470741

CLAAS MEGA 360 TYP C12



7		644141.1	1	1000476	4014486467475
8		644447.0	1	1000420	4014486466836
9		623427.1	1	1000409	4014486466720
11	N = 660	785341.0	1	1000295	4014486464870
11	N = 519	066034.0	1	1000302	4014486465037
13		544172.0	1	1001745	4014486487299
14		603380.1	1	1001080	4014486498240
15		609762.0	1	1001713	4014486486919
17		644538.0	1	1001655	4014486486094
19		506671.2	1	1000506	4014486467840
20	FROM NO. 84500262	821734.2	1	1000154	4014486461763
20	TO NO. 84500261	545689.0	1	1003332	4014486461886
21	TO NO. 84500261	545668.1	1	1000119	4014486461305
22		644537.0	1	1000140	4014486461572
23	TO NO. 84500386 HIGH - LOW SPEED RANGE TRANSMISSION	609823.0	1	1001225	4014486497809
23	FROM NO. 84500387	661427.0	1	1001228	4014486497847
24	DRUM VARIABLE SPEED DRIVE N = 650 - 1500	661220.1	1	1003340	4014486488807

CLAAS MEGA 370



No.	Application	OEM - PN	Set	Optibelt AP-Nr.	EAN
	ALTERNATOR DRIVE (TILL NR. 84500261)	545954.0	1	1002646	4014486480849
	ALTERNATOR DRIVE (FROM NR. 84500262)	796998.0	1	1003945	4014486481969
1		544049.1	2	1001561	4014486484618
2		656028.0	1	1003335	4014486462869
2		629002.1	1	1003395	4014486462715
3		621903.1	1	1002041	4014486475166
4		544166.0	1	1003360	4014486484830
5		544164.0	1	1001969	4014486490800
6		603337.0	1	1000662	4014486470260
6		667238.0	1	1000693	4014486470741
7		644141.1	1	1000476	4014486467475
8		644447.0	1	1000420	4014486466836
9		623427.1	1	1000409	4014486466720
11		785341.0	1	1000295	4014486464870

CLAAS MEGA 370



11		066034.0	1	1000302	4014486465037
13		544172.0	1	1001745	4014486487299
14		603380.1	1	1001080	4014486498240
15		609762.0	1	1001713	4014486486919
17		644538.0	1	1001655	4014486486094
19		506671.2	1	1000506	4014486467840
20	FROM NR. 84500262	821734.2	1	1000154	4014486461763
20	TO NR. 84500261	545689.0	1	1003332	4014486461886
21	TO NR. 84500261	545668.1	1	1000119	4014486461305
22		644537.0	1	1000140	4014486461572
23	TO NR. 84500386 HIGH - LOW SPEED	609823.0	1	1001225	4014486497809
23	FROM NR. 84500387	661427.0	1	1001228	4014486497847
24	DRUM DRIVE VARIABLE SPEED (N=650-1500 RPM)	661220.1	1	1003340	4014486488807

CLAAS MEGA 370 TYP 845



No.	Application	OEM - PN	Set	Optibelt AP-Nr.	EAN
	ALTERNATOR FROM NR. 84500261	545954.0	1	1002646	4014486480849
	ALTERNATOR FROM NO. 84500262	796998.0	1	1003945	4014486481969
1	1 SET = 2 BELTS	544049.1	2	1001561	4014486484618
2		656028.0	1	1003335	4014486462869
2	WHEN THRESHING	629002.1	1	1003395	4014486462715
3		621903.1	1	1002041	4014486475166
4		544166.0	1	1003360	4014486484830
5		544164.0	1	1001969	4014486490800
6		603337.0	1	1000662	4014486470260
6	WHEN THRESHING	667238.0	1	1000693	4014486470741
7		644141.1	1	1000476	4014486467475
8		644447.0	1	1000420	4014486466836
9		623427.1	1	1000409	4014486466720
11	N = 660	785341.0	1	1000295	4014486464870

CLAAS MEGA 370 TYP 845



11	N = 519	066034.0	1	1000302	4014486465037
13		544172.0	1	1001745	4014486487299
14		603380.1	1	1001080	4014486498240
15		609762.0	1	1001713	4014486486919
17		644538.0	1	1001655	4014486486094
19		506671.2	1	1000506	4014486467840
20	FROM NO. 84500262	821734.2	1	1000154	4014486461763
20	TO NO. 84500261	545689.0	1	1003332	4014486461886
21	TO NO. 84500261	545668.1	1	1000119	4014486461305
22		644537.0	1	1000140	4014486461572
23	TO NO. 84500386 HIGH - LOW SPEED RANGE TRANSMISSION	609823.0	1	1001225	4014486497809
23	FROM NO. 84500387	661427.0	1	1001228	4014486497847
24	DRUM VARIABLE SPEED DRIVE N = 650 - 1500	661220.1	1	1003340	4014486488807

BISO - Schrattecker
 BIZON
 CASE INTL. HARVESTER
 CLAAS
 DEUTZ-FAHR
 DRONNING-BORG
 FENDT
 FORTSCHRITT
 JOHN DEERE
 KRONE
 LAVERDA
 MASSEY FERGUSON
 NEW HOLLAND
 ROSTSELMASH

CLAAS MEGA 370 TYP 846



No.	Application	OEM - PN	Set	Optibelt AP-Nr.	EAN
	ALTERNATOR FROM NR. 84500261	545954.0	1	1002646	4014486480849
	ALTERNATOR FROM NO. 84500262	796998.0	1	1003945	4014486481969
1	1 SET = 2 BELTS	544049.1	2	1001561	4014486484618
2		656028.0	1	1003335	4014486462869
2	WHEN THRESHING	629002.1	1	1003395	4014486462715
3		621903.1	1	1002041	4014486475166
4		544166.0	1	1003360	4014486484830
5		544164.0	1	1001969	4014486490800
6		603337.0	1	1000662	4014486470260
6	WHEN THRESHING	667238.0	1	1000693	4014486470741
7		644141.1	1	1000476	4014486467475
8		644447.0	1	1000420	4014486466836
9		623427.1	1	1000409	4014486466720
11		785341.0	1	1000295	4014486464870

CLAAS MEGA 370 TYP 846



11	N = 519	066034.0	1	1000302	4014486465037
13		544172.0	1	1001745	4014486487299
14		603380.1	1	1001080	4014486498240
15		609762.0	1	1001713	4014486486919
17		644538.0	1	1001655	4014486486094
19		506671.2	1	1000506	4014486467840
20	FROM NO. 84500262	821734.2	1	1000154	4014486461763
20	TO NO. 84500261	545689.0	1	1003332	4014486461886
21	TO NO. 84500261	545668.1	1	1000119	4014486461305
22		644537.0	1	1000140	4014486461572
23	TO NO. 84500386 HIGH - LOW SPEED RANGE TRANSMISSION	609823.0	1	1001225	4014486497809
23	FROM NO. 84500387	661427.0	1	1001228	4014486497847
24	DRUM VARIABLE SPEED DRIVE N = 650 - 1500	661220.1	1	1003340	4014486488807

BISO - Schrattecker
 BIZON
 CASE INTL. HARVESTER
 CLAAS
 DEUTZ-FAHR
 DRONNING-BORG
 FENDT
 FORTSCHRITT
 JOHN DEERE
 KRONE
 LAVERDA
 MASSEY FERGUSON
 NEW HOLLAND
 ROSTSELMASH

CLAAS MEGA 370 TYP C12



No.	Application	OEM - PN	Set	Optibelt AP-Nr.	EAN
	ALTERNATOR TILL NR. 84500261	545954.0	1	1002646	4014486480849
	ALTERNATOR FROM NO. 84500262	796998.0	1	1003945	4014486481969
1	1 SET = 2 BELTS	544049.1	2	1001561	4014486484618
2		656028.0	1	1003335	4014486462869
2	WHEN THRESHING	629002.1	1	1003395	4014486462715
3		621903.1	1	1002041	4014486475166
4		544166.0	1	1003360	4014486484830
5		544164.0	1	1001969	4014486490800
6		603337.0	1	1000662	4014486470260
6	WHEN THRESHING	667238.0	1	1000693	4014486470741
7		644141.1	1	1000476	4014486467475
8		644447.0	1	1000420	4014486466836
9		623427.1	1	1000409	4014486466720
11	N = 660	785341.0	1	1000295	4014486464870

CLAAS MEGA 370 TYP C12



11	N = 519	066034.0	1	1000302	4014486465037
13		544172.0	1	1001745	4014486487299
14		603380.1	1	1001080	4014486498240
15		609762.0	1	1001713	4014486486919
17		644538.0	1	1001655	4014486486094
19		506671.2	1	1000506	4014486467840
20	FROM NO. 84500262	821734.2	1	1000154	4014486461763
20	TO NO. 84500261	545689.0	1	1003332	4014486461886
21	TO NO. 84500261	545668.1	1	1000119	4014486461305
22		644537.0	1	1000140	4014486461572
23	TO NO. 84500386 HIGH - LOW SPEED RANGE TRANSMISSION	609823.0	1	1001225	4014486497809
23	FROM NO. 84500387	661427.0	1	1001228	4014486497847
24	DRUM VARIABLE SPEED DRIVE N = 650 - 1500	661220.1	1	1003340	4014486488807

BISO - Schrattecker
BIZON
CASE INTL. HARVESTER
CLAAS
DEUTZ-FAHR
DRONNING-BORG
FENDT
FORTSCHRITT
JOHN DEERE
KRONE
LAVERDA
MASSEY FERGUSON
NEW HOLLAND
ROSTSELMASH

CLAAS MERCATOR



No.	Application	OEM - PN	Set	Optibelt AP-Nr.	EAN
3	MAIN DRIVE	653059.0	1	1000960	4014486474183
3	MAIN DRIVE	653062.0	1	1000964	4014486474220
3	MAIN DRIVE	630144.0	1	1000965	4014486474244
3	MAIN DRIVE	653064.0	1	1000968	4014486474275
4	MAIN DRIVE	653060.0	1	1003653	4014486489514
5	CUTTING TABLE DRIVE	653063.0	1	1003572	4014486497045
6	SHAKER SHOE DRIVE	653120.0	1	1000929	4014486473797
7	FANNING MILL	653121.0	1	1001030	4014486496291
8	STRAW SPREADER DRIVE	653450.0	1	1002137	4014486476491
9	HYDRAULIC PUMP DRIVE	656028.0	1	1003335	4014486462869
10	REEL DRIVE VARIABLE SPEED	778561.0	1	1001038	4014486496376
11	STRAW WALKER DRIVE	653933.0	1	1002119	4014486476200
12	UNLOADING GRAIN TANK	654534.0	1	1000913	4014486473629
13	TRACTION DRIVE	655408.0	1	1001527	4014486460469
14	THROW OFF DRIVE	750294.0	1	1000251	4014486463897

CLAAS MERCATOR 50



No.	Application	OEM - PN	Set	Optibelt AP-Nr.	EAN
1	MAIN DRIVE	653060.0	1	1003653	4014486489514
2	HYDRAULIC PUMP DRIVE	656028.0	1	1003335	4014486462869
3	MAIN DRIVE	653059.0	1	1000960	4014486474183
3	MAIN DRIVE	653062.0	1	1000964	4014486474220
3	MAIN DRIVE	630144.0	1	1000965	4014486474244
3	MAIN DRIVE	653064.0	1	1000968	4014486474275
4	REEL DRIVE VARIABLE SPEED	778561.0	1	1001038	4014486496376
6	CUTTING TABLE DRIVE	653063.0	1	1003572	4014486497045
8	FANNING MILL	653121.0	1	1001030	4014486496291
9	SHAKER SHOE DRIVE	653120.0	1	1000929	4014486473797
10	DRIVE GRAIN TANK	653450.0	1	1002137	4014486476491
11	STRAW WALKER DRIVE	653933.0	1	1002119	4014486476200
12	TURNING DRUM DRIVE	750294.0	1	1000251	4014486463897
13	TANK UNLOADER DRIVE	653779.0	1	1000909	4014486473551
14	TRACTION DRIVE	655408.0	1	1001527	4014486460469

CLAAS MERCATOR 60



No.	Application	OEM - PN	Set	Optibelt AP-Nr.	EAN
1	MAIN DRIVE	653060.0	1	1003653	4014486489514
2	HYDRAULIC PUMP DRIVE	656028.0	1	1003335	4014486462869
3	MAIN DRIVE	653059.0	1	1000960	4014486474183
3	MAIN DRIVE	653062.0	1	1000964	4014486474220
3	MAIN DRIVE	630144.0	1	1000965	4014486474244
3	MAIN DRIVE	653064.0	1	1000968	4014486474275
4	REEL DRIVE VARIABLE SPEED	778561.0	1	1001038	4014486496376
6	CUTTING TABLE DRIVE	653063.0	1	1003572	4014486497045
8	FANNING MILL	653121.0	1	1001030	4014486496291
9	SHAKER SHOE DRIVE	653120.0	1	1000929	4014486473797
10	DRIVE GRAIN TANK	653450.0	1	1002137	4014486476491
11	STRAW WALKER DRIVE	653933.0	1	1002119	4014486476200
12	TURNING DRUM DRIVE	750294.0	1	1000251	4014486463897
13	TANK UNLOADER DRIVE	653779.0	1	1000909	4014486473551
14	TRACTION DRIVE	655408.0	1	1001527	4014486460469

CLAAS MERCATOR 75



No.	Application	OEM - PN	Set	Optibelt AP-Nr.	EAN
1	MAIN DRIVE	653060.0	1	1003653	4014486489514
2	HYDRAULIC PUMP DRIVE	656028.0	1	1003335	4014486462869
3	MAIN DRIVE	653059.0	1	1000960	4014486474183
3	MAIN DRIVE	653062.0	1	1000964	4014486474220
3	MAIN DRIVE	630144.0	1	1000965	4014486474244
3	MAIN DRIVE	653064.0	1	1000968	4014486474275
4	REEL DRIVE VARIABLE SPEED	778561.0	1	1001038	4014486496376
6	CUTTING TABLE DRIVE	653063.0	1	1003572	4014486497045
9	SHAKER SHOE DRIVE	653120.0	1	1000929	4014486473797
10	DRIVE GRAIN TANK	653450.0	1	1002137	4014486476491
11	TURNING DRUM DRIVE	750294.0	1	1000251	4014486463897
12	STRAW WALKER DRIVE	653933.0	1	1002119	4014486476200
13	TANK UNLOADER DRIVE	654534.0	1	1000913	4014486473629
14	TRACTION DRIVE	655408.0	1	1001527	4014486460469
15	SHAKER SHAFT DRIVE	687046.0	1	1003448	4014486465495

CLAAS MERCATOR S 70



No.	Application	OEM - PN	Set	Optibelt AP-Nr.	EAN
1	MAIN DRIVE	653060.0	1	1003653	4014486489514
2	HYDRAULIC PUMP DRIVE	656028.0	1	1003335	4014486462869
3	MAIN DRIVE	653059.0	1	1000960	4014486474183
3	MAIN DRIVE	653062.0	1	1000964	4014486474220
3	MAIN DRIVE	630144.0	1	1000965	4014486474244
3	MAIN DRIVE	653064.0	1	1000968	4014486474275
4	REEL DRIVE VARIABLE SPEED	778561.0	1	1001038	4014486496376
6	CUTTING TABLE DRIVE	653063.0	1	1003572	4014486497045
9	SHAKER SHOE DRIVE	653120.0	1	1000929	4014486473797
10	DRIVE GRAIN TANK	653450.0	1	1002137	4014486476491
11	TURNING DRUM DRIVE	750294.0	1	1000251	4014486463897
12	STRAW WALKER DRIVE	653933.0	1	1002119	4014486476200
13	TANK UNLOADER DRIVE	654534.0	1	1000913	4014486473629
14	TRACTION DRIVE	655408.0	1	1001527	4014486460469
15	SHAKER SHAFT DRIVE	687046.0	1	1003448	4014486465495

CLAAS MERCUR



No.	Application	OEM - PN	Set	Optibelt AP-Nr.	EAN
1	BALER	500863.0	1	1000902	4014486473483
2	RADIATOR FAN DRIVE	758719.0	1	1003405	4014486463309
3	KNIFE DRIVE	770214.0	1	1003560	4014486473391
4	SPREADER GRAIN IN TANK	775698.0	1	1000272	4014486464429
5	REEL DRIVE VARIABLE SPEED	778561.0	1	1001038	4014486496376
7	CUTTING TABLE DRIVE	779214.0	1	1000452	4014486467215
7	CUTTING TABLE DRIVE	779272.0	1	1000459	4014486467284
8	TANK UNLOADER DRIVE	780419.0	1	1003559	4014486473254
9	PICK UP DRIVE	800309.0	1	1003435	4014486464719
10	STRAW CHOPPER DRIVE	551190.0	1	1000933	4014486473841
11	TRACTION VARIATOR DRIVE	751112.0	1	1001161	4014486497427
13	TRACTION DRIVE	758853.0	1	1000456	4014486467253
14	THRESHING MACHINE	758854.0	1	1000449	4014486467161
16	SHAKER SHOE FAN ELEVATOR - BALER	779212.0	1	1000486	4014486467574
17	SHAKER SHOE FAN ELEVATOR	779213.0	1	1000482	4014486467536

CLAAS OLDER MODELS, PROTECTOR

No.	Application	OEM - PN	Set	Optibelt AP-Nr.	EAN
1	FAN DRIVE	505143.0	1	1000513	4014486467925
2	BALER	506023.0	1	1000928	4014486473780
3	GOVERNOR DRIVE	624131.0	1	1000194	4014486462289
6	STRAW WALKER DRIVE	501925.0	1	1003449	4014486465501
8	CYLINDER	503969.0	1	1000956	4014486520293
9	PICK UP DRIVE	507020.0	2	1002788	4014486466201
3	MAIN DRIVE	653059.0	1	1000960	4014486474183
3	MAIN DRIVE	653062.0	1	1000964	4014486474220
3	MAIN DRIVE	630144.0	1	1000965	4014486474244
3	MAIN DRIVE	653064.0	1	1000968	4014486474275
4	CYLINDER DRIVE	653060.0	1	1003653	4014486489514
5	CUTTING TABLE DRIVE	653063.0	1	1003572	4014486497045
6	SHAKER SHOE DRIVE	653120.0	1	1000929	4014486473797
7	FANNING MILL	653121.0	1	1001030	4014486496291
8	SHAKER SHOE DRIVE	653450.0	1	1002137	4014486476491
9	HYDRAULIC PUMP DRIVE	656028.0	1	1003335	4014486462869
10	REEL DRIVE VARIABLE SPEED	778561.0	1	1001038	4014486496376
11	TANK UNLOADER DRIVE	653779.0	1	1000909	4014486473551
12	STRAW WALKER DRIVE	653933.0	1	1002119	4014486476200
13	TRACTION DRIVE	655408.0	1	1001527	4014486460469
14	TURNING DRUM DRIVE	750294.0	1	1000251	4014486463897

CLAAS SENATOR



No.	Application	OEM - PN	Set	Optibelt AP-Nr.	EAN
3	MAIN DRIVE	653059.0	1	1000960	4014486474183
3	MAIN DRIVE	653062.0	1	1000964	4014486474220
3	MAIN DRIVE	630144.0	1	1000965	4014486474244
3	MAIN DRIVE	653064.0	1	1000968	4014486474275
5	CYLINDER	653060.0	1	1003653	4014486489514
6	CUTTING TABLE DRIVE	653063.0	1	1003572	4014486497045
7	SHAKER SHOE DRIVE	653120.0	1	1000929	4014486473797
8	FANNING MILL	653121.0	1	1001030	4014486496291
9	REEL DRIVE VARIABLE SPEED	778561.0	1	1001038	4014486496376
10	TRACTION DRIVE	631904.0	1	1001162	4014486497434
10	TRACTION DRIVE	655408.0	1	1001527	4014486460469
11	TANK UNLOADER DRIVE	654013.0	1	1002233	4014486477955
12	TURNING DRUM DRIVE	750294.0	1	1000251	4014486463897
13	STRAW WALKER DRIVE	653933.0	1	1002119	4014486476200
13	STRAW WALKER DRIVE	801222.0	4	1002798	4014486465808

CLAAS SF



No.	Application	OEM - PN	Set	Optibelt AP-Nr.	EAN
1	DRIVE GRAIN TANK	636021.0	1	1000882	4014486473223
2	DRIVE GRAIN TANK	636021.1	1	1000883	4014486473230
3	ENGINE	624131.0	1	1000194	4014486462289
5	STRAW SHAKER	618123.0	1	1003434	4014486464634
6	CUTTING TABLE DRIVE	610197.0	1	1000903	4014486473490
8	MAIN DRIVE	630144.0	1	1000965	4014486474244
9	TRACTION DRIVE	630156.0	1	1000980	4014486474404
12	MAIN DRIVE	630118.0	1	1000959	4014486474169

CLAAS TUCANO 330/320



BISO - Schrattecker
 BIZON
 CASE INTL. HARVESTER
 CLAAS
 DEUTZ-FAHR
 DRONNING-BORG
 FENDT
 FORTSCHRITT
 JOHN DEERE
 KRONE
 LAVERDA
 MASSEY FERGUSON
 NEW HOLLAND
 ROSTSELMASH

No.	Application	OEM - PN	Set	Optibelt AP-Nr.	EAN
1		554017.0	2	1003974	4014486472790
3		549099.0	1	1003966	4014486491708
4		667251.1	1	1003601	4014486485219
5		603247.1	1	1003626	4014486488111
6		603337.0	1	1000662	4014486470260
7		644362.0	1	1001077	4014486498219
8		644267.0	1	1000243	4014486463613
9		644141.1	1	1000476	4014486467475
10		609762.0	1	1001713	4014486486919
11		506671.2	1	1000506	4014486467840
12		644447.0	1	1000420	4014486466836
13		544216.0	1	1003967	4014486465938
14		629402.0	1	1000409	4014486466720
15		633030.2	1	1000220	4014486462838
40		544172.0	1	1001745	4014486487299
41		061700.1	1	1003356	4014486486131
42		661427.0	1	1001228	4014486497847
43		661220.1	1	1003340	4014486488807
44		661429.0	1	1001212	4014486497717
45		077276.0	1	1000177	4014486462067
46		799181.0	1	1003970	4014486481808
47		549752.0	2	1002745	4014486460957

CLAAS TUCANO 340



No.	Application	OEM - PN	Set	Optibelt AP-Nr.	EAN
1		554017.0	2	1003974	4014486472790
3		549099.0	1	1003966	4014486491708
4		667251.1	1	1003601	4014486485219
5		544049.1	2	1001561	4014486484618
6		603337.0	1	1000662	4014486470260
7		644362.0	1	1001077	4014486498219
8		538714.0	1	1003403	4014486463194
9		644141.1	1	1000476	4014486467475
10		609762.0	1	1001713	4014486486919
11		506671.2	1	1000506	4014486467840
12		644447.0	1	1000420	4014486466836
13		544216.0	1	1003967	4014486465938
14		629402.0	1	1000409	4014486466720
15		633030.2	1	1000220	4014486462838
40		544172.0	1	1001745	4014486487299
41		061700.1	1	1003356	4014486486131
42		661427.0	1	1001228	4014486497847
43		661220.1	1	1003340	4014486488807
44		661429.0	1	1001212	4014486497717
45		077276.0	1	1000177	4014486462067
46		799181.0	1	1003970	4014486481808
47		549752.0	2	1002745	4014486460957

CLAAS TUCANO 430



BISO - Schrattecker
 BIZON
 CASE INTL. HARVESTER
 CLAAS
 DEUTZ-FAHR
 DRONNING-BORG
 FENDT
 FORTSCHRITT
 JOHN DEERE
 KRONE
 LAVERDA
 MASSEY FERGUSON
 NEW HOLLAND
 ROSTSELMASH

No.	Application	OEM - PN	Set	Optibelt AP-Nr.	EAN
1		549055.0	2	1003968	4014486520309
2		661031.1	1	1001564	4014486484663
3		549099.0	1	1003966	4014486491708
4		667251.1	1	1003601	4014486485219
5		544049.1	2	1001561	4014486484618
6		603337.0	1	1000662	4014486470260
7		644362.0	1	1001077	4014486498219
8		538714.0	1	1003403	4014486463194
9		644141.1	1	1000476	4014486467475
10		609762.0	1	1001713	4014486486919
11		506671.2	1	1000506	4014486467840
12		644447.0	1	1000420	4014486466836
13		544216.0	1	1003967	4014486465938
14		629402.0	1	1000409	4014486466720
15		633030.2	1	1000220	4014486462838
40		544172.0	1	1001745	4014486487299
41		061700.1	1	1003356	4014486486131
42		661427.0	1	1001228	4014486497847
43		661220.1	1	1003340	4014486488807
45		077276.0	1	1000177	4014486462067
46		799181.0	1	1003970	4014486481808
47		549752.0	2	1002745	4014486460957

CLAAS TUCANO 450/440



No.	Application	OEM - PN	Set	Optibelt AP-Nr.	EAN
1		549055.0	2	1003968	4014486520309
2		661031.1	1	1001564	4014486484663
3		549099.0	1	1003966	4014486491708
4		667251.1	1	1003601	4014486485219
5		544049.1	2	1001561	4014486484618
6		603337.0	1	1000662	4014486470260
7		644362.0	1	1001077	4014486498219
8		538714.0	1	1003403	4014486463194
9		644141.1	1	1000476	4014486467475
10		609762.0	1	1001713	4014486486919
11		506671.2	1	1000506	4014486467840
12		644447.0	1	1000420	4014486466836
13		544216.0	1	1003967	4014486465938
14		629402.0	1	1000409	4014486466720
15		633030.2	1	1000220	4014486462838
40		544172.0	1	1001745	4014486487299
41		061700.1	1	1003356	4014486486131
42		661427.0	1	1001228	4014486497847
43		661220.1	1	1003340	4014486488807
45		077276.0	1	1000177	4014486462067
46		799181.0	1	1003970	4014486481808
47		549752.0	2	1002745	4014486460957

DEUTZ-FAHR 100 Z



No.	Application	OEM - PN	Set	Optibelt AP-Nr.	EAN
1	BLADE CONTROL	06212919	1	1000463	4014486467338
2	ELEVATOR DRIVE UNIT	06210921	1	1000356	4014486466133
3	ENGINE DRIVE	06215236	1	1001679	4014486486483
4	STRAW SPREADER DRIVE	06215250	1	1001833	4014486488562
5	ENGINE DRIVE	06215237	1	1003655	4014486489651
6	STRAW DISTRIBUTOR	06210989	1	1003526	4014486470086
7	STRAW CUTTER	06211001	1	1000751	4014486471496
8	STRAW CUTTER	06211006	1	1003550	4014486471908
10	TRACTION DRIVE	06215213	1	1001519	4014486460384
11	TANK	06212924	1	1002211	4014486477627
12	STRAW DISTRIBUTOR	06212925	1	1003686	4014486477757
13	RETURN DRIVE	06212925	1	1003686	4014486477757
14	VENTILATOR	06215197	1	1001066	4014486496505
15	REEL DRIVE VARIABLE SPEED	06215217	1	1001157	4014486497366

DEUTZ-FAHR M 1000



No.	Application	OEM - PN	Set	Optibelt AP-Nr.	EAN
	CUTTING MECHANICAL COUNTERSHAFT - KNIFE DRIVE	06210991	1	1000660	4014486470246
	REEL DRIVE VARIABLE SPEED	06215217	1	1001157	4014486497366
3	GEARBOX GRAIN TANK	06241147	2	1000468	4014486467390
5	RETURN ELEVATOR DRIVE	06240268	1	1001372	4014486474862
6	STRAW STRIPPER DRUM	06211026	1	1003561	4014486473421
7	PLATFORM FEED CHANNEL	06211026	1	1003561	4014486473421
8	COUNTERSHAFT - FEED CHANNEL	06210915	1	1000339	4014486520217
9	COUNTERSHAFT - PICK UP	06210915	1	1000339	4014486520217
11	COUNTERSHAFT - BALER	01139301	1	1000779	4014486471915
12	BALER	06210997	1	1003541	4014486470864
13	REEL DRIVE COUNTERSHAFT	06215196	1	1001064	4014486496482
15	COUNTERSHAFT - FAN DRIVE	06215199	1	1001071	4014486496550
16	ALTERNATOR DRIVE	01139218	1	1002465	4014486493504
17	RADIATOR FAN DRIVE	01139221	1	1002478	4014486493696
17	RADIATOR FAN DRIVE	01139222	1	1002483	4014486493801
19	THRESHING DRUM VARIATOR DRIVE	06215222	1	1001223	4014486497786

DEUTZ-FAHR M 1002



BISO - Schrattecker
BIZON
CASE INTL. HARVESTER
CLAAS
DEUTZ-FAHR
DRONNING-BORG
FENDT
FORTSCHRITT
JOHN DEERE
KRONE
LAVERDA
MASSEY FERGUSON
ROSTSELMASH
NEW HOLLAND

No.	Application	OEM - PN	Set	Optibelt AP-Nr.	EAN
	ALTERNATOR DRIVE (ENGINE) / -1980 M1002	02235179	1	1002460	4014486493436
	ALTERNATOR DRIVE (ENGINE) /+1981 M1002/1080	02235180	1	1002462	4014486493467
	BLOWER DRIVE (ENGINE) / M1002	02235533	1	1002482	4014486493788
1	ENGINE - COUNTERSHAFT / M1002	06215237	1	1003655	4014486489651
2	COUNTERSHAFT - FAN DRIVE	06215197	1	1001066	4014486496505
3	THRESHING DRUM VARIATOR DRIVE	06215220	1	1001222	4014486497779
4	REEL DRIVE VARIABLE SPEED	06215217	1	1001157	4014486497366
5	SHAFT KNIFE DRIVE	06212919	1	1000463	4014486467338
6	PLATFORM FEED CHANNEL	06210989	1	1003526	4014486470086
7	COUNTERSHAFT - TRAVEL SPEED VARIATOR /-4232 M900-1002	06215213	1	1001519	4014486460384
8	COUNTERSHAFT - GRAIN TANK	06212924	1	1002211	4014486477627
9	TENSION ARM /M900+2660.M922+2706.M1002+2827	06210991	1	1000660	4014486470246
9	TENSION ARM /M900-2659.M922-2530.M1002-2826	06212925	1	1003686	4014486477757
10	RETURN ELEVATOR DRIVE	06210991	1	1000660	4014486470246
10	RETURN ELEVATOR DRIVE	06212925	1	1003686	4014486477757
11	COUNTERSHAFT - STRAW STRIPPER DRUM	06215250	1	1001833	4014486488562
12	ELEVATOR DRIVE GRAIN	06210921	1	1000356	4014486466133
13	CHOPPER DRIVE	06211001	1	1000751	4014486471496
14	CHOPPER DRIVE	06211006	1	1003550	4014486471908

DEUTZ-FAHR M 1102



No.	Application	OEM - PN	Set	Optibelt AP-Nr.	EAN
	CUTTING MECHANICAL COUNTERSHAFT - KNIFE DRIVE	06210991	1	1000660	4014486470246
	REEL DRIVE VARIABLE SPEED	06215217	1	1001157	4014486497366
3	DRIVE GRAIN TANK	06241147	2	1000468	4014486467390
4	STRAW STRIPPER DRUM - COUNTERSHAFT	06212933	1	1002235	4014486477986
5	COUNTERSHAFT - RETURN ELEVATOR	06240268	1	1001372	4014486474862
6	STRAW STRIPPER DRUM - COUNTERSHAFT	06211026	1	1003561	4014486473421
7	STRAW STRIPPER DRUM - FEED CHANNEL	06211031	1	1000907	4014486473544
8	CHOPPER DRIVE	01141798	1	1000792	4014486472110
9	CHOPPER DRIVE	01136747	1	1002240	4014486478051
11	FAN DRIVE VARIABLE SPEED	06215199	1	1001071	4014486496550
12	THRESHING DRUM VARIATOR DRIVE	06215222	1	1001223	4014486497786
13	BLOWER DRIVE	02235254	1	1002483	4014486493801
14	ALTERNATOR DRIVE	02235180	1	1002462	4014486493467

DEUTZ-FAHR M 1200



No.	Application	OEM - PN	Set	Optibelt AP-Nr.	EAN
	CUTTING MECHANICAL COUNTERSHAFT - KNIFE DRIVE	06210991	1	1000660	4014486470246
	REEL DRIVE VARIABLE SPEED	06215217	1	1001157	4014486497366
3	GEARBOX GRAIN TANK	06241147	2	1000468	4014486467390
5	RETURN ELEVATOR DRIVE	06240268	1	1001372	4014486474862
6	STRAW STRIPPER DRUM	06211026	1	1003561	4014486473421
7	PLATFORM FEED CHANNEL	06211026	1	1003561	4014486473421
8	COUNTERSHAFT - FEED CHANNEL	06210915	1	1000339	4014486520217
9	COUNTERSHAFT - PICK UP	06210915	1	1000339	4014486520217
11	COUNTERSHAFT - BALER	01139301	1	1000779	4014486471915
12	BALER	06210997	1	1003541	4014486470864
13	REEL DRIVE COUNTERSHAFT	06215196	1	1001064	4014486496482
15	COUNTERSHAFT - FAN DRIVE	06215199	1	1001071	4014486496550
16	ALTERNATOR DRIVE	01139218	1	1002465	4014486493504
17	RADIATOR FAN DRIVE	01139221	1	1002478	4014486493696
17	RADIATOR FAN DRIVE	01139222	1	1002483	4014486493801
19	THRESHING DRUM VARIATOR DRIVE	06215222	1	1001223	4014486497786

DEUTZ-FAHR M 1202



No.	Application	OEM - PN	Set	Optibelt AP-Nr.	EAN
	CUTTING MECHANICAL COUNTERSHAFT - KNIFE DRIVE	06210991	1	1000660	4014486470246
	REEL DRIVE VARIABLE SPEED	06215217	1	1001157	4014486497366
3	DRIVE GRAIN TANK	06241147	2	1000468	4014486467390
4	STRAW STRIPPER DRUM - COUNTERSHAFT	06212933	1	1002235	4014486477986
5	COUNTERSHAFT - RETURN ELEVATOR	06240268	1	1001372	4014486474862
6	STRAW STRIPPER DRUM - COUNTERSHAFT	06211026	1	1003561	4014486473421
7	STRAW STRIPPER DRUM - FEED CHANNEL	06211031	1	1000907	4014486473544
8	CHOPPER DRIVE	01141798	1	1000792	4014486472110
9	CHOPPER DRIVE	01136747	1	1002240	4014486478051
11	FAN DRIVE VARIABLE SPEED	06215199	1	1001071	4014486496550
12	THRESHING DRUM VARIATOR DRIVE	06215222	1	1001223	4014486497786
13	BLOWER DRIVE	02235254	1	1002483	4014486493801
14	ALTERNATOR DRIVE	02235180	1	1002462	4014486493467

DEUTZ-FAHR M 1300



No.	Application	OEM - PN	Set	Optibelt AP-Nr.	EAN
	CUTTING MECHANICAL COUNTERSHAFT - KNIFE DRIVE	06210991	1	1000660	4014486470246
	REEL DRIVE VARIABLE SPEED	06215217	1	1001157	4014486497366
2	DISCHARGE DRIVE GRAIN TANK	06215234	1	1001696	4014486486728
3	THRESHING DRUM VARIATOR DRIVE	06215222	1	1001223	4014486497786
3	THRESHING DRUM VARIATOR DRIVE	06215221	1	1001227	4014486497823
4	COUNTERSHAFT - THRESHING DRUM	06256381	1	1000306	4014486497960
5	SHAKER SHOE FAN DRIVE	01139241	1	1002193	4014486477412
6	FAN DRIVE	06210869	1	1003377	4014486461435
7	CHOPPER DRIVE	01129970	1	1002247	4014486478143
9	CLUTCH GRAIN TANK	06211014	1	1000879	4014486473193
11	SHAKER TRANSMISSION	06256619	2	1002762	4014486465570
12	RETURN ELEVATOR DRIVE	06210917	1	1000343	4014486465921
13	SHAKER SHOE DRIVE	06256714	3	1002763	4014486464290
14	MAIN DRIVE	06255583	2	1002910	4014486472288
15	TRACTION VARIATOR DRIVE	06215222	1	1001223	4014486497786

DEUTZ-FAHR M 1302



No.	Application	OEM - PN	Set	Optibelt AP-Nr.	EAN
	CUTTING MECHANICAL COUNTERSHAFT - KNIFE DRIVE	06210991	1	1000660	4014486470246
	REEL DRIVE VARIABLE SPEED	06215217	1	1001157	4014486497366
2	DISCHARGE DRIVE GRAIN TANK	06215234	1	1001696	4014486486728
3	THRESHING DRUM VARIATOR DRIVE	06215222	1	1001223	4014486497786
3	THRESHING DRUM VARIATOR DRIVE	06215221	1	1001227	4014486497823
4	COUNTERSHAFT - THRESHING DRUM	06256381	1	1000306	4014486497960
5	SHAKER SHOE FAN DRIVE	01139241	1	1002193	4014486477412
6	FAN DRIVE	06210869	1	1003377	4014486461435
7	CHOPPER DRIVE	01129970	1	1002247	4014486478143
9	CLUTCH GRAIN TANK	06211014	1	1000879	4014486473193
11	SHAKER TRANSMISSION	06256619	2	1002762	4014486465570
12	RETURN ELEVATOR DRIVE	06210917	1	1000343	4014486465921
13	SHAKER SHOE DRIVE	06256714	3	1002763	4014486464290
14	MAIN DRIVE	06255583	2	1002910	4014486472288
15	TRACTION VARIATOR DRIVE	06215222	1	1001223	4014486497786

DEUTZ-FAHR M 1302 H



No.	Application	OEM - PN	Set	Optibelt AP-Nr.	EAN
	CUTTING MECHANICAL COUNTERSHAFT - KNIFE DRIVE	06210991	1	1000660	4014486470246
	REEL DRIVE VARIABLE SPEED	06215217	1	1001157	4014486497366
2	DISCHARGE DRIVE GRAIN TANK	06215234	1	1001696	4014486486728
3	THRESHING DRUM VARIATOR DRIVE	06215222	1	1001223	4014486497786
3	THRESHING DRUM VARIATOR DRIVE	06215221	1	1001227	4014486497823
4	COUNTERSHAFT - THRESHING DRUM	06256381	1	1000306	4014486497960
5	SHAKER SHOE FAN DRIVE	01139241	1	1002193	4014486477412
6	FAN DRIVE	06210869	1	1003377	4014486461435
7	CHOPPER DRIVE	01129970	1	1002247	4014486478143
9	CLUTCH GRAIN TANK	06211014	1	1000879	4014486473193
11	SHAKER TRANSMISSION	06256619	2	1002762	4014486465570
12	RETURN ELEVATOR DRIVE	06210917	1	1000343	4014486465921
13	SHAKER SHOE DRIVE	06256714	3	1002763	4014486464290
14	MAIN DRIVE	06255583	2	1002910	4014486472288
15	TRACTION VARIATOR DRIVE	06215222	1	1001223	4014486497786

DEUTZ-FAHR M 1600

No.	Application	OEM - PN	Set	Optibelt AP-Nr.	EAN
		06211014	1	1000879	4014486473193
		06211034	1	1000923	4014486473728
		06215242	1	1001686	4014486486599
		01141613	1	1001749	4014486487329
		02234343	2	1002485	4014486493856
		06210890	1	1003410	4014486463477
		01141645	1	1003620	4014486486957
1	STRAW STRIPPER DRUM	06215259	1	1002016	4014486491494
2	DISCHARGE DRIVE GRAIN TANK	06215235	1	1001699	4014486486759
3	THRESHING DRUM VARIATOR DRIVE	06215222	1	1001223	4014486497786
3	THRESHING DRUM VARIATOR DRIVE	06215221	1	1001227	4014486497823
4	COUNTERSHAFT - THRESHING DRUM	06256381	1	1000306	4014486497960
4	COUNTERSHAFT - THRESHING DRUM	06256546	3	1002759	4014486465013
5	SHAKER SHOE FAN DRIVE	01139242	1	1002200	4014486477504
6	FAN DRIVE	06210869	1	1003377	4014486461435
7	ENGINE - ALTERNATOR	01139216	1	1002458	4014486493412
8	CHOPPER DRIVE	06257897	2	1000854	4014486472868
10	KNIFE DRIVE	06212919	1	1000463	4014486467338
12	SHAKER TRANSMISSION	06256619	2	1002762	4014486465570
13	RETURN ELEVATOR DRIVE	06210917	1	1000343	4014486465921
14	SHAKER SHOE DRIVE	06256714	3	1002763	4014486464290

DEUTZ-FAHR M 1620



BISO - Schrattecker
BIZON
CASE INTL. HARVESTER
CLAAS
DEUTZ-FAHR
DRONNING-BORG
FENDT
FORTSCHRITT
JOHN DEERE
KRONE
LAVERDA
MASSEY FERGUSON
NEW HOLLAND
ROSTSELMASH

No.	Application	OEM - PN	Set	Optibelt AP-Nr.	EAN
		06211014	1	1000879	4014486473193
		06211034	1	1000923	4014486473728
		06215242	1	1001686	4014486486599
		01141613	1	1001749	4014486487329
		02234343	2	1002485	4014486493856
		06210890	1	1003410	4014486463477
		01141645	1	1003620	4014486486957
1	STRAW STRIPPER DRUM	06215259	1	1002016	4014486491494
2	DISCHARGE DRIVE GRAIN TANK	06215235	1	1001699	4014486486759
3	THRESHING DRUM VARIATOR DRIVE	06215222	1	1001223	4014486497786
3	THRESHING DRUM VARIATOR DRIVE	06215221	1	1001227	4014486497823
4	COUNTERSHAFT - THRESHING DRUM	06256381	1	1000306	4014486497960
4	COUNTERSHAFT - THRESHING DRUM	06256546	3	1002759	4014486465013
5	SHAKER SHOE FAN DRIVE	01139242	1	1002200	4014486477504
6	FAN DRIVE	06210869	1	1003377	4014486461435
7	ENGINE - ALTERNATOR	01139216	1	1002458	4014486493412
8	CHOPPER DRIVE	06257897	2	1000854	4014486472868
10	KNIFE DRIVE	06212919	1	1000463	4014486467338
12	SHAKER TRANSMISSION	06256619	2	1002762	4014486465570
13	RETURN ELEVATOR DRIVE	06210917	1	1000343	4014486465921
14	SHAKER SHOE DRIVE	06256714	3	1002763	4014486464290

DEUTZ-FAHR M 1630

No.	Application	OEM - PN	Set	Optibelt AP-Nr.	EAN
		06211014	1	1000879	4014486473193
		06211034	1	1000923	4014486473728
		06215242	1	1001686	4014486486599
		01141613	1	1001749	4014486487329
		02234343	2	1002485	4014486493856
		06210890	1	1003410	4014486463477
		01141645	1	1003620	4014486486957
1	STRAW STRIPPER DRUM	06215259	1	1002016	4014486491494
2	DISCHARGE DRIVE GRAIN TANK	06215235	1	1001699	4014486486759
3	THRESHING DRUM VARIATOR DRIVE	06215222	1	1001223	4014486497786
3	THRESHING DRUM VARIATOR DRIVE	06215221	1	1001227	4014486497823
4	COUNTERSHAFT - THRESHING DRUM	06256381	1	1000306	4014486497960
4	COUNTERSHAFT - THRESHING DRUM	06256546	3	1002759	4014486465013
5	SHAKER SHOE FAN DRIVE	01139242	1	1002200	4014486477504
6	FAN DRIVE	06210869	1	1003377	4014486461435
7	ENGINE - ALTERNATOR	01139216	1	1002458	4014486493412
8	CHOPPER DRIVE	06257897	2	1000854	4014486472868
10	KNIFE DRIVE	06212919	1	1000463	4014486467338
12	SHAKER TRANSMISSION	06256619	2	1002762	4014486465570
13	RETURN ELEVATOR DRIVE	06210917	1	1000343	4014486465921
14	SHAKER SHOE DRIVE	06256714	3	1002763	4014486464290

DEUTZ-FAHR M 2385

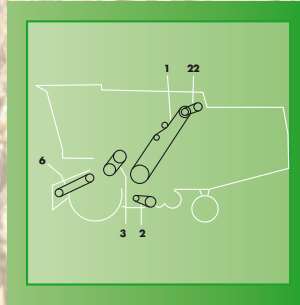
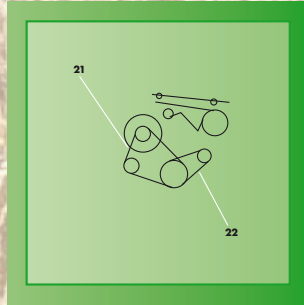
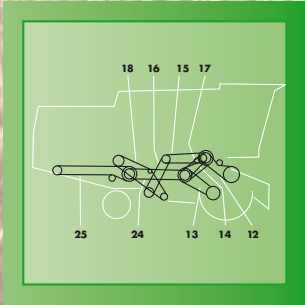

No.	Application	OEM - PN	Set	Optibelt AP-Nr.	EAN
	CUTTING MECHANICAL COUNTERSHAFT - KNIFE DRIVE	06210991	1	1000660	4014486470246
	REEL DRIVE VARIABLE SPEED	06215217	1	1001157	4014486497366
1	MAIN DRIVE	06285949	1	1001916	4014486489828
1	MAIN DRIVE	06215243	1	1003616	4014486486667
2	COUNTERSHAFT - FAN DRIVE	06215197	1	1001066	4014486496505
3	STRAW STRIPPER DRUM - THRESHING DRUM	06215220	1	1001222	4014486497779
6	FEEDER CHANNEL - COUNTERSHAFT	06215205	1	1001100	4014486496826
12	STRAW STRIPPER DRUM - FEED CHANNEL	06215204	1	1001097	4014486496796
13	COUNTERSHAFT - TRAVEL SPEED VARIATOR	06215216	1	1001522	4014486460414
14	COUNTERSHAFT - GRAIN TANK	06212924	1	1002211	4014486477627
15	STRAW STRIPPER DRUM - TENSION ARM	06210991	1	1000660	4014486470246
16	RETURN ELEVATOR - TENSION ARM	06210991	1	1000660	4014486470246
18	STRAW WALKER - GRAIN ELEVATOR	06210927	1	1000390	4014486466539
22	ALTERNATOR DRIVE	02235180	1	1002462	4014486493467
24	CHOPPER DRIVE	06273236	1	1000736	4014486471298

DEUTZ-FAHR M 2480

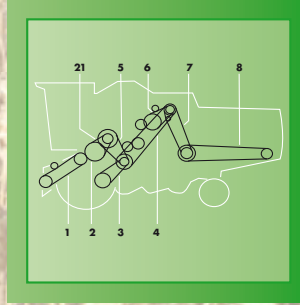
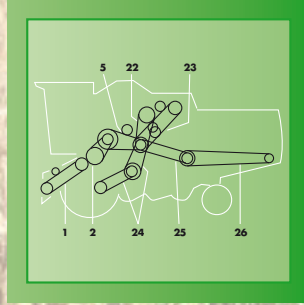
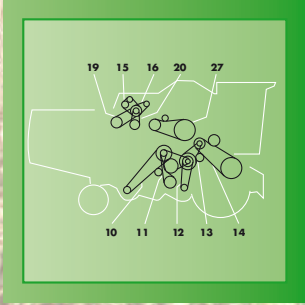

No.	Application	OEM - PN	Set	Optibelt AP-Nr.	EAN
	CUTTING MECHANICAL COUNTERSHAFT - KNIFE DRIVE	06210991	1	1000660	4014486470246
	REEL DRIVE VARIABLE SPEED	06215217	1	1001157	4014486497366
1	FEEDER CHANNEL - COUNTERSHAFT	06215205	1	1001100	4014486496826
2	STRAW STRIPPER DRUM - THRESHING DRUM	06215220	1	1001222	4014486497779
3	DRIVING SPEED VARIATOR / M2580-M2685	06215214	1	1001517	4014486460360
4	ENGINE - COUNTERSHAFT / M2580.2680.2780H	06215258	1	1001912	4014486489750
5	COUNTERSHAFT - STRAW STRIPPER DRUM	06215253	1	1001843	4014486488722
7	ENGINE - CHOPPER TRANSMISSION / +102	06215245	1	1001763	4014486487466
7	ENGINE - CHOPPER TRANSMISSION / W /-100	06210851	2	1003535	4014486470567
8	CHOPPER DRIVE / M2580.2680	01139258	1	1002245	4014486478112
10	COUNTERSHAFT - RETURN ELEVATOR	06210922	1	1000360	4014486466188
10	COUNTERSHAFT - RETURN ELEVATOR (MAIZE)	06210923	1	1000364	4014486466232
11	COUNTERSHAFT - WALKER + SHAKER SHOE DRIVE	06215255	1	1003331	4014486489224
12	COUNTERSHAFT - FAN DRIVE	06215202	1	1001420	4014486459272

DEUTZ-FAHR M 2480

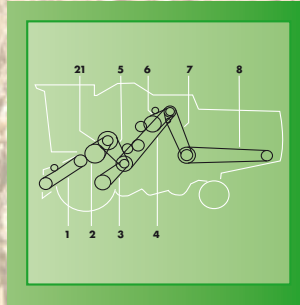
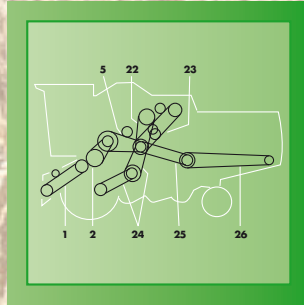
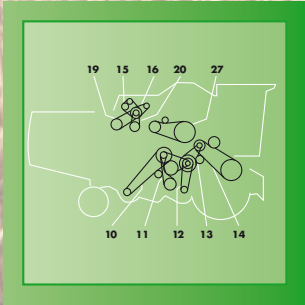

13	STRAW STRIPPER DRUM - COUNTERSHAFT	06215240	1	1001578	4014486484823
14	STRIPPER DRUM - FEED CHANNEL / M2480-M2680	06215203	1	1001094	4014486496765
15	BLOWER DRIVE / M2480 - M2680	02235532	2	1002925	4014486493795
16	ALTERNATOR DRIVE	02235180	1	1002462	4014486493467
19	ENGINE - COMPRESSOR	01139233	1	1002558	4014486495034
20	ENGINE - FAN / M2480 - M2685	01139204	1	1002257	4014486478242
22	COUNTERSHAFT - GRAIN TANK / M2480	06210975	1	1000599	4014486469318
23	ENGINE - COUNTERSHAFT / M2480	06215257	1	1001882	4014486489330
24	TRAVEL SPEED VARIATOR	06215209	2	1001472	4014486459821
26	CHOPPER DRIVE / M2480	01139259	1	1002246	4014486478129
27	GRAIN TANK DRIVE / + 437 M2480	06210993	1	1003531	4014486470406

DEUTZ-FAHR M 2780

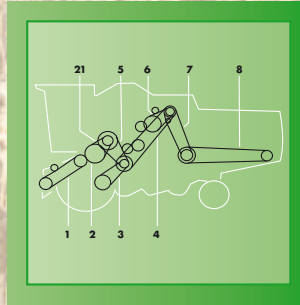
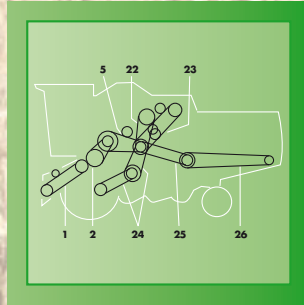
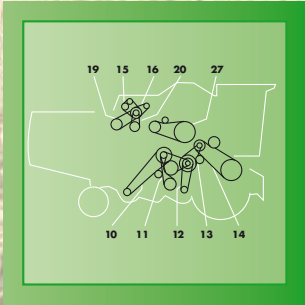

No.	Application	OEM - PN	Set	Optibelt AP-Nr.	EAN
	CUTTING MECHANICAL COUNTERSHAFT - KNIFE DRIVE	06210991	1	1000660	4014486470246
	REEL DRIVE VARIABLE SPEED	06215217	1	1001157	4014486497366
1	FEEDER CHANNEL - COUNTERSHAFT	06215205	1	1001100	4014486496826
2	STRAW STRIPPER DRUM - THRESHING DRUM	06215220	1	1001222	4014486497779
3	DRIVING SPEED VARIATOR / M2580-M2685	06215214	1	1001517	4014486460360
4	ENGINE - COUNTERSHAFT / M2580.2680.2780H	06215258	1	1001912	4014486489750
4	ENGINE - COUNTERSHAFT / M2685.2780	06215262	1	1002022	4014486491579
5	COUNTERSHAFT - STRIPPER DRUM / M2580 - M2780H	06215239	1	1001601	4014486485233
5	COUNTERSHAFT - STRAW STRIPPER DRUM	06215253	1	1001843	4014486488722
7	ENGINE - CHOPPER TRANSMISSION / +102	06215245	1	1001763	4014486487466
7	ENGINE - CHOPPER TRANSMISSION / W /-100	06210851	2	1003535	4014486470567
8	CHOPPER DRIVE / M2685.2780H.2780	01139260	1	1002251	4014486478181
10	COUNTERSHAFT - RETURN ELEVATOR	06210922	1	1000360	4014486466188
10	COUNTERSHAFT - RETURN ELEVATOR (MAIZE)	06210923	1	1000364	4014486466232
11	COUNTERSHAFT - WALKER + SHAKER SHOE DRIVE	06215255	1	1003331	4014486489224
12	COUNTERSHAFT - FAN DRIVE	06215202	1	1001420	4014486459272
13	STRAW STRIPPER DRUM - COUNTERSHAFT	06215240	1	1001578	4014486484823
14	STRIPPER DRUM - FEED CHANNEL / M2685.2780.2780H	06215238	1	1001628	4014486485684
15	BLOWER DRIVE / M2685 - 2780H.2780	02234343	2	1002485	4014486493856
16	ALTERNATOR DRIVE	02235180	1	1002462	4014486493467
19	ENGINE - COMPRESSOR	01139233	1	1002558	4014486495034
27	GRAIN TANK DRIVE / + 437 M2580 - M2780H	06210990	1	1000654	4014486470178

DEUTZ-FAHR M 3280

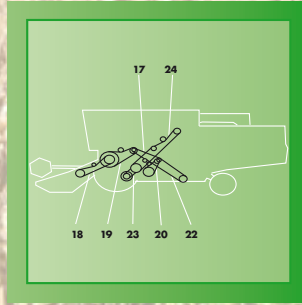
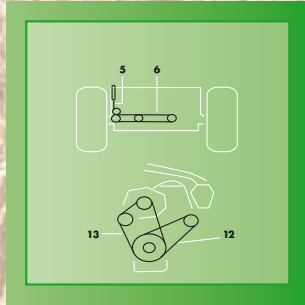
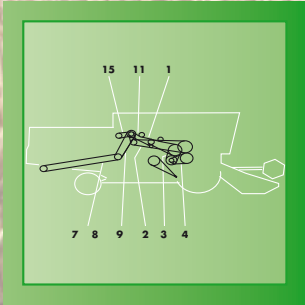

No.	Application	OEM - PN	Set	Optibelt AP-Nr.	EAN
1		01141591	1	1001902	4014486489620
2		01141666	1	1000794	4014486472134
3		06215222	1	1001223	4014486497786
4		06256546	3	1002759	4014486465013
5		01139241	1	1002193	4014486477412
11		01141613	1	1001749	4014486487329
17		06256619	2	1002762	4014486465570
18		01141595	2	1002907	4014486471304
18		01141615	1	1003624	4014486487589
19		01141608	1	1001637	4014486485868
20		06256714	3	1002763	4014486464290
23		01141971	1	1001224	4014486497793
24		06215244	1	1001787	4014486487756

DEUTZ-FAHR M 3480



No.	Application	OEM - PN	Set	Optibelt AP-Nr.	EAN
1		06211031	1	1000907	4014486473544
2		01141820	1	1001067	4014486496512
3		01141850	1	1000398	4014486466614
4		01141816	1	1001630	4014486485738
5		01141819	1	1001644	4014486485967
6		01141918	1	1001650	4014486486025
7		01141912	1	1003631	4014486488500
8		01141909	1	1001909	4014486489712
9		01141938	1	1003513	4014486469547
10		01141917	1	1000659	4014486470239
11		01141958	1	1000682	4014486470581
12		06215214	1	1001517	4014486460360
13		06215222	1	1001223	4014486497786
14		01141944	1	1001226	4014486497816

DEUTZ-FAHR M 3540



No.	Application	OEM - PN	Set	Optibelt AP-Nr.	EAN
1		06211031	1	1000907	4014486473544
2		01141820	1	1001067	4014486496512
3		01141850	1	1000398	4014486466614
4		01141816	1	1001630	4014486485738
5		01141819	1	1001644	4014486485967
6		01141918	1	1001650	4014486486025
7		01141912	1	1003631	4014486488500
8		01141909	1	1001909	4014486489712
9		01141938	1	1003513	4014486469547
10		01141917	1	1000659	4014486470239
11		01141958	1	1000682	4014486470581
12		06215214	1	1001517	4014486460360
13		06215222	1	1001223	4014486497786
14		01141944	1	1001226	4014486497816

BISO - Schrattecker
 BIZON
 CASE INTL. HARVESTER
 CLAAS
 DEUTZ-FAHR
 DRONNINGBORG
 FENDT
 FORTSCHRITT
 JOHN DEERE
 KRONE
 LAVERDA
 MASSEY FERGUSON
 NEW HOLLAND
 ROSTSELMASH

DEUTZ-FAHR M 3570

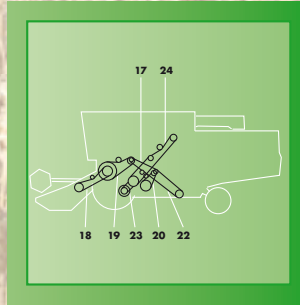
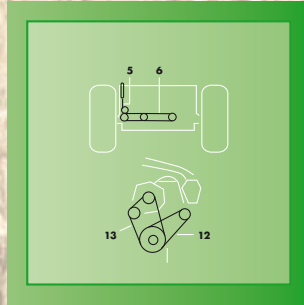
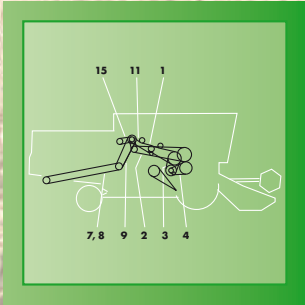

No.	Application	OEM - PN	Set	Optibelt AP-Nr.	EAN
	CUTTING MECHANICAL COUNTERSHAFT - KNIFE DRIVE	06210991	1	1000660	4014486470246
	REEL DRIVE VARIABLE SPEED	06215217	1	1001157	4014486497366
		01141971	1	1001224	4014486497793
		06257898	2	1002911	4014486470666
1	STRAW STRIPPER DRUM	01141591	1	1001902	4014486489620
2	DISCHARGE DRIVE GRAIN TANK	01141666	1	1000794	4014486472134
3	THRESHING DRUM VARIATOR DRIVE	06215222	1	1001223	4014486497786
4	COUNTERSHAFT - THRESHING DRUM	06256546	3	1002759	4014486465013
5	STRAW WALKER - FAN	01139241	1	1002193	4014486477412
6	CLEANING FAN DRIVE	06210890	1	1003410	4014486463477
8	STRAW CHOPPER - STRAW HOOD	01141645	1	1003620	4014486486957
11	ENGINE - GRAIN TANK CLUTCH / M3570	06211014	1	1000879	4014486473193
12	ALTERNATOR DRIVE	02235180	1	1002462	4014486493467
13	BLOWER DRIVE	02234343	2	1002485	4014486493856
17	STRAW STRIPPER DRUM - WALKER TRANSMISSION	06256619	2	1002762	4014486465570
18	CUTTING TABLE DRIVE	01141595	2	1002907	4014486471304
18	PICKING - ATTACHMENTS DRIVE (MAIZE)	01141615	1	1003624	4014486487589
19	STRAW STRIPPER DRUM - FEED CHANNEL	01141608	1	1001637	4014486485868
20	SHAKER SHOE - WALKER TRANSMISSION	06256714	3	1002763	4014486464290
22	RETURN ELEVATOR - WALKER TRANSMISSION	06210917	1	1000343	4014486465921
23	TRAVEL SPEED VARIATOR	06215223	1	1001223	4014486497786
24	ENGINE - COUNTERSHAFT	06215244	1	1001787	4014486487756

DEUTZ-FAHR M 3578

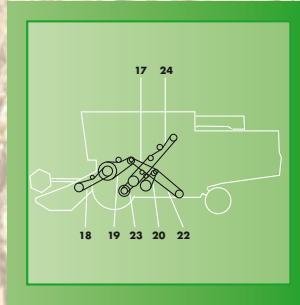
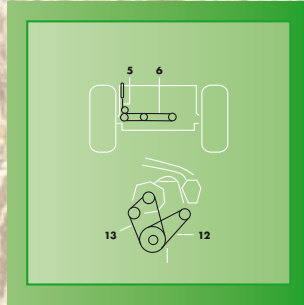
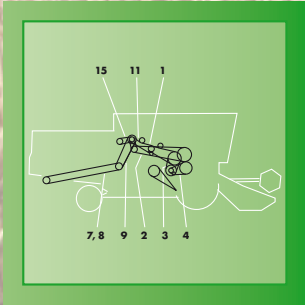

No.	Application	OEM - PN	Set	Optibelt AP-Nr.	EAN
	CUTTING MECHANICAL COUNTERSHAFT - KNIFE DRIVE	06210991	1	1000660	4014486470246
	REEL DRIVE VARIABLE SPEED	06215217	1	1001157	4014486497366
		01141971	1	1001224	4014486497793
		06257898	2	1002911	4014486470666
1	STRAW STRIPPER DRUM	01141591	1	1001902	4014486489620
2	DISCHARGE DRIVE GRAIN TANK	01141666	1	1000794	4014486472134
3	THRESHING DRUM VARIATOR DRIVE	06215222	1	1001223	4014486497786
4	COUNTERSHAFT - THRESHING DRUM	06256546	3	1002759	4014486465013
5	STRAW WALKER - FAN	01139241	1	1002193	4014486477412
6	CLEANING FAN DRIVE	06210890	1	1003410	4014486463477
8	STRAW CHOPPER - STRAW HOOD	01141645	1	1003620	4014486486957
11	ENGINE - GRAIN TANK CLUTCH / M3570	06211014	1	1000879	4014486473193
11	ENGINE - GRAIN TANK CLUTCH / M3580	01141613	1	1001749	4014486487329
12	ALTERNATOR DRIVE	02235180	1	1002462	4014486493467
13	BLOWER DRIVE	02234343	2	1002485	4014486493856
17	STRAW STRIPPER DRUM - WALKER TRANSMISSION	06256619	2	1002762	4014486465570
18	CUTTING TABLE DRIVE	01141595	2	1002907	4014486471304
18	PICKING - ATTACHMENTS DRIVE (MAIZE)	01141615	1	1003624	4014486487589
19	STRAW STRIPPER DRUM - FEED CHANNEL	01141608	1	1001637	4014486485868
20	SHAKER SHOE - WALKER TRANSMISSION	06256714	3	1002763	4014486464290
22	RETURN ELEVATOR - WALKER TRANSMISSION	06210917	1	1000343	4014486465921
23	TRAVEL SPEED VARIATOR	06215223	1	1001223	4014486497786

DEUTZ-FAHR M 3578, M 3580

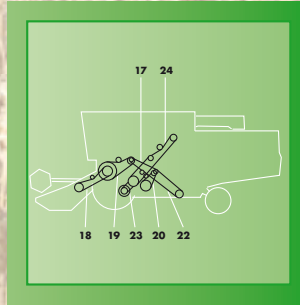
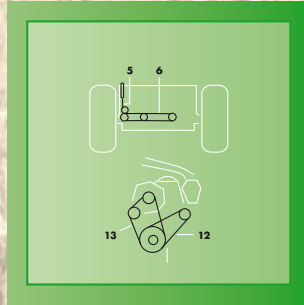
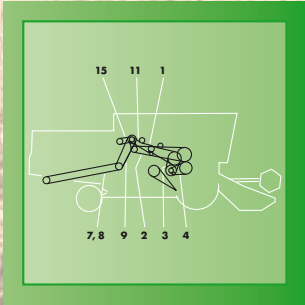

No.	Application	OEM - PN	Set	Optibelt AP-Nr.	EAN
24	ENGINE - COUNTERSHAFT	06215244	1	1001787	4014486487756
1		06211034	1	1000923	4014486473728
2		06256714	3	1002763	4014486464290
3		06256546	3	1002759	4014486465013
4		06256619	2	1002762	4014486465570
5		01141789	1	1003462	4014486466966
6		01141591	1	1001902	4014486489620
7		01141666	1	1000794	4014486472134
8		01141613	1	1001749	4014486487329
9		06215222	1	1001223	4014486497786
10		01141971	1	1001224	4014486497793
11		01139241	1	1002193	4014486477412

DEUTZ-FAHR M 3610



BISO - Schrattecker
BIZON
CASE INTL. HARVESTER
CLAAS
DEUTZ-FAHR
DRONNING-BORG
FENDT
FORTSCHRITT
JOHN DEERE
KRONE
LAVERDA
MASSEY FERGUSON
NEW HOLLAND
ROSTSELMASH

No.	Application	OEM - PN	Set	Optibelt AP-Nr.	EAN
1	ENGINE - STRAW STRIPPER DRUM / M3610	06211034	1	1000923	4014486473728
2	REEL DRIVE VARIABLE SPEED	06215217	1	1001157	4014486497366
3		02235177	2	1002487	4014486493894
4		06256714	3	1002763	4014486464290
5		06256546	3	1002759	4014486465013
6		06256619	2	1002762	4014486465570
7		01141789	1	1003462	4014486466966
8	STRAW CHOPPER - STRAW HOOD / M3610	01141941	1	1001865	4014486489057
9		01141591	1	1001902	4014486489620
10	CUTTING MECHANICAL COUNTERSHAFT - KNIFE DRIVE	06210991	1	1000660	4014486470246
11		01141666	1	1000794	4014486472134
12		01141613	1	1001749	4014486487329
13		06215222	1	1001223	4014486497786
14		01139241	1	1002193	4014486477412
15		01139242	1	1002200	4014486477504
16		01141645	1	1003620	4014486486957
17		02234343	2	1002485	4014486493856
18		02235180	1	1002462	4014486493467
19		06210890	1	1003410	4014486463477
21		06257898	2	1002911	4014486470666

DEUTZ-FAHR M 3630

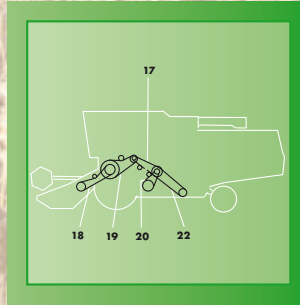
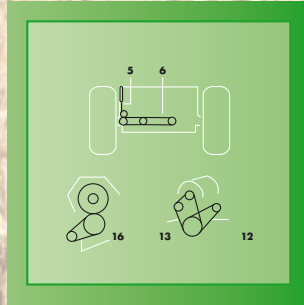
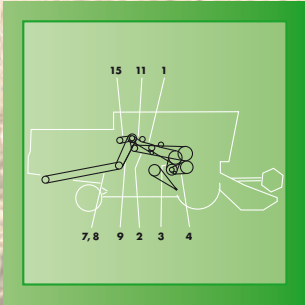

No.	Application	OEM - PN	Set	Optibelt AP-Nr.	EAN
		01141530	1	1000435	4014486467024
		01141613	1	1001749	4014486487329
		01141941	1	1001865	4014486489057
		01141591	1	1001902	4014486489620
		01141510	1	1002013	4014486491432
		06257898	2	1002911	4014486470666
		01141789	1	1003462	4014486466966
2	ENGINE - GRAIN TANK EMPTYING	01141666	1	1000794	4014486472134
3	THRESHING DRUM VARIATOR DRIVE	06215222	1	1001223	4014486497786
4	COUNTERSHAFT - THRESHING DRUM	06256546	3	1002759	4014486465013
5	STRAW WALKER - FAN	01139242	1	1002200	4014486477504
6	CLEANING FAN DRIVE	06210890	1	1003410	4014486463477

DEUTZ-FAHR M 3630

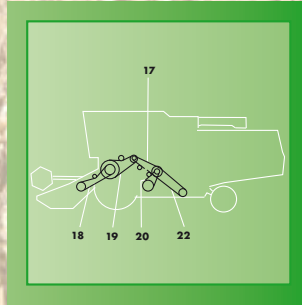
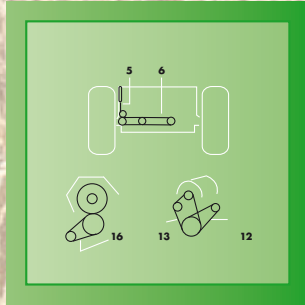
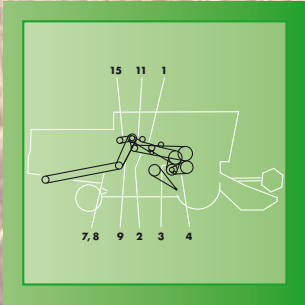

8	STRAW CHOPPER - STRAW HOOD / M3630/M3640	01141749	1	1001738	4014486487220
11	ENGINE - GRAIN TANK CLUTCH	01141613	1	1001749	4014486487329
12	ALTERNATOR DRIVE / TYPE 6204	02235180	1	1002462	4014486493467
13	BLOWER DRIVE / -262 TYPE 6204	02234343	2	1002485	4014486493856
13	BLOWER DRIVE / +263 TYPE 6204	02235177	2	1002487	4014486493894
16	ALTERNATOR DRIVE / TYPE 6208	02235713	1	1002451	4014486493313
17	STRAW STRIPPER DRUM - WALKER TRANSMISSION	06256619	2	1002762	4014486465570
18	CUTTING TABLE DRIVE	01141595	2	1002907	4014486471304
18	PICKING - ATTACHMENTS DRIVE (MAIZE)	01141615	1	1003624	4014486487589
19	STRAW STRIPPER DRUM - FEED CHANNEL	01141608	1	1001637	4014486485868
20	SHAKER SHOE - WALKER TRANSMISSION	06256714	3	1002763	4014486464290
22	RETURN ELEVATOR - WALKER TRANSMISSION	06210917	1	1000343	4014486465921

DEUTZ-FAHR M 3640

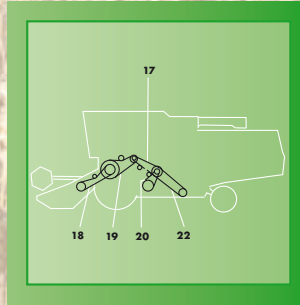
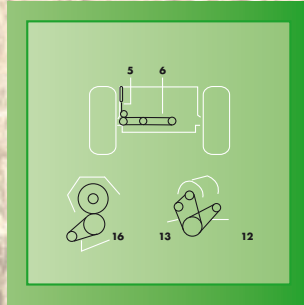
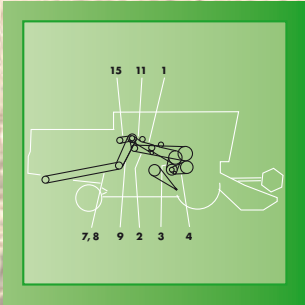

No.	Application	OEM - PN	Set	Optibelt AP-Nr.	EAN
		01141530	1	1000435	4014486467024
		01141613	1	1001749	4014486487329
		01141941	1	1001865	4014486489057
		01141591	1	1001902	4014486489620
		01141510	1	1002013	4014486491432
		06257898	2	1002911	4014486470666
		01141789	1	1003462	4014486466966
2	ENGINE - GRAIN TANK EMPTYING	01141666	1	1000794	4014486472134
3	THRESHING DRUM VARIATOR DRIVE	06215222	1	1001223	4014486497786
4	COUNTERSHAFT - THRESHING DRUM	06256546	3	1002759	4014486465013
5	STRAW WALKER - FAN	01139242	1	1002200	4014486477504
6	CLEANING FAN DRIVE	06210890	1	1003410	4014486463477

DEUTZ-FAHR M 3640

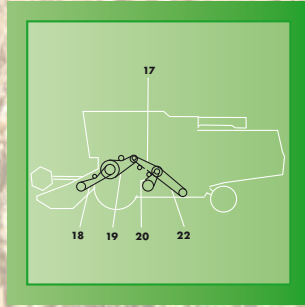
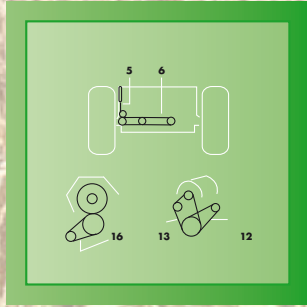
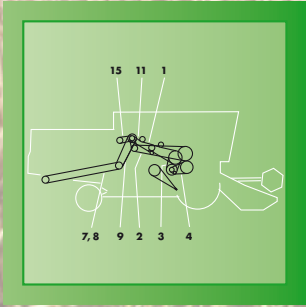

8	STRAW CHOPPER - STRAW HOOD / M3630/M3640	01141749	1	1001738	4014486487220
11	ENGINE - GRAIN TANK CLUTCH	01141613	1	1001749	4014486487329
12	ALTERNATOR DRIVE / TYPE 6204	02235180	1	1002462	4014486493467
13	BLOWER DRIVE / -262 TYPE 6204	02234343	2	1002485	4014486493856
13	BLOWER DRIVE / +263 TYPE 6204	02235177	2	1002487	4014486493894
16	ALTERNATOR DRIVE / TYPE 6208	02235713	1	1002451	4014486493313
17	STRAW STRIPPER DRUM - WALKER TRANSMISSION	06256619	2	1002762	4014486465570
18	CUTTING TABLE DRIVE	01141595	2	1002907	4014486471304
18	PICKING - ATTACHMENTS DRIVE (MAIZE)	01141615	1	1003624	4014486487589
19	STRAW STRIPPER DRUM - FEED CHANNEL	01141608	1	1001637	4014486485868
20	SHAKER SHOE - WALKER TRANSMISSION	06256714	3	1002763	4014486464290
22	RETURN ELEVATOR - WALKER TRANSMISSION	06210917	1	1000343	4014486465921

DEUTZ-FAHR M 600



No.	Application	OEM - PN	Set	Optibelt AP-Nr.	EAN
2	UNLOADING DRIVE	06212915	1	1000447	4014486467147
4	STRAW CHOPPER COUNTERSHAFT	06211034	1	1000923	4014486473728
6	COUNTERSHAFT - PICK UP	01130742	1	1003431	4014486464313
7	PICK UP DRIVE	06210915	1	1000339	4014486520217
8	ELEVATOR DRIVE GRAIN	06210922	1	1000360	4014486466188
9	STRAW BALER	01139090	1	1000926	4014486473766
10	COUNTERSHAFT - BALER	01139089	1	1000902	4014486473483
11	STRAW CHOPPER DRIVE	01139085	1	1000784	4014486472004
13	REEL DRIVE	06215195	1	1001062	4014486496468
14	RETURN ELEVATOR DRIVE	01100903	3	1002851	4014486465112
15	SHAKER SHOE DRIVE	01116080	1	1000196	4014486462333
15	RADIATOR FAN DRIVE	01139216	1	1002458	4014486493412
15	ALTERNATOR DRIVE	01139217	1	1002459	4014486493429

DEUTZ-FAHR M 660



No.	Application	OEM - PN	Set	Optibelt AP-Nr.	EAN
2	COUNTERSHAFT - GRAIN TANK	06212915	1	1000447	4014486467147
4	STRAW STRIPPER DRUM - RETURN AUGER	06211034	1	1000923	4014486473728
5	STRAW STRIPPER DRUM - CONVEYOR PASSAGE	06211053	1	1000893	4014486473353
6	ANGULAR GEAR - CHOPPER TRANSMISSION	06211001	1	1000751	4014486471496
7	CHOPPER DRIVE / M660	01139082	1	1003544	4014486470963
9	STRAW WALKER - GRAIN AUGER	06210922	1	1000360	4014486466188
10	RETURN AUGER - CHOPPER / M660	01139085	1	1000784	4014486472004
11	STRAW STRIPPER DRUM - COUNTERSHAFT	01139247	1	1000445	4014486467123
16	REEL DRIVE COUNTERSHAFT	06215195	1	1001062	4014486496468
18	RETURN AUGER - VARIATOR	01100903	3	1002851	4014486465112
19	FAN DRIVE VARIABLE SPEED	01116080	1	1000196	4014486462333
21	BLOWER DRIVE	02235175	1	1002478	4014486493696
22	ALTERNATOR DRIVE	02235178	1	1002459	4014486493429

DEUTZ-FAHR M 750



No.	Application	OEM - PN	Set	Optibelt AP-Nr.	EAN
2	UNLOADING SYSTEM	06212915	1	1000447	4014486467147
3	UNLOADING SYSTEM	01139247	1	1000445	4014486467123
5	STRAW CHOPPER DRIVE	06211034	1	1000923	4014486473728
6	STRAW STRIPPER DRUM	06211053	1	1000893	4014486473353
7	PLATFORM CHANNEL	01130742	1	1003431	4014486464313
8	PICK UP DRIVE	06210915	1	1000339	4014486520217
9	ELEVATOR SHAKER GRAIN	06210922	1	1000360	4014486466188
10	CHOPPER DRIVE	06211010	1	1000826	4014486472523
12	REEL DRIVE	06215195	1	1001062	4014486496468
13	RETURN ELEVATOR DRIVE	01100903	3	1002851	4014486465112
14	SHAKER SHOE DRIVE	01116080	1	1000196	4014486462333
14	ALTERNATOR DRIVE	01139216	1	1002458	4014486493412
14	RADIATOR FAN DRIVE	01139220	1	1002475	4014486493627

DEUTZ-FAHR M 770, M 88, M 88 S



BISO - Schrattecker
BIZON
CASE INTL. HARVESTER
CLAAS
DEUTZ-FAHR
DRONNING-BORG
FENDT
FORTSCHRITT
JOHN DEERE
KRONE
LAVERDA
MASSEY FERGUSON
ROSTSELMASH
NEW HOLLAND

No.	Application	OEM - PN	Set	Optibelt AP-Nr.	EAN
2	COUNTERSHAFT - GRAIN TANK	06212915	1	1000447	4014486467147
4	STRAW STRIPPER DRUM - RETURN AUGER	06211034	1	1000923	4014486473728
5	STRAW STRIPPER DRUM - CONVEYOR PASSAGE	06211053	1	1000893	4014486473353
6	ANGULAR GEAR - CHOPPER TRANSMISSION	06211001	1	1000751	4014486471496
7	CHOPPER DRIVE / M770	06211004	1	1000769	4014486471748
9	STRAW WALKER - GRAIN AUGER	06210922	1	1000360	4014486466188
10	RETURN AUGER - CHOPPER / M770	06211010	1	1000826	4014486472523
11	STRAW STRIPPER DRUM - COUNTERSHAFT	01139247	1	1000445	4014486467123
16	REEL DRIVE COUNTERSHAFT	06215195	1	1001062	4014486496468
18	RETURN AUGER - VARIATOR	01100903	3	1002851	4014486465112
19	FAN DRIVE VARIABLE SPEED	01116080	1	1000196	4014486462333
21	BLOWER DRIVE	02235175	1	1002478	4014486493696
22	ALTERNATOR DRIVE	02235178	1	1002459	4014486493429
1		01100903	3	1002851	4014486465112
4		06215195	1	1001062	4014486496468
1		01100903	3	1002851	4014486465112
4		06215195	1	1001062	4014486496468

DEUTZ-FAHR M 900

No.	Application	OEM - PN	Set	Optibelt AP-Nr.	EAN
	ALTERNATOR DRIVE (ENGINE) /+2281 M900-980	02235178	1	1002459	4014486493429
	BLOWER DRIVE (ENGINE) / M900/922	02235531	1	1002475	4014486493627
1	BLADE CONTROL	06212919	1	1000463	4014486467338
1	ENGINE - COUNTERSHAFT / M900/922/980/1080	06215236	1	1001679	4014486486483
2	ELEVATOR DRIVE UNIT	06210921	1	1000356	4014486466133
2	COUNTERSHAFT - FAN DRIVE	06215197	1	1001066	4014486496505
3	THRESHING DRUM VARIATOR DRIVE	06215220	1	1001222	4014486497779
3	ENGINE DRIVE	06215236	1	1001679	4014486486483
4	REEL DRIVE VARIABLE SPEED	06215217	1	1001157	4014486497366
4	STRAW SPREADER DRIVE	06215250	1	1001833	4014486488562
5	SHAFT KNIFE DRIVE	06212919	1	1000463	4014486467338
5	ENGINE DRIVE	06215237	1	1003655	4014486489651
6	PLATFORM FEED CHANNEL	06210989	1	1003526	4014486470086
6	STRAW DISTRIBUTOR	06210989	1	1003526	4014486470086
7	STRAW CUTTER	06211001	1	1000751	4014486471496
7	COUNTERSHAFT - TRAVEL SPEED VARIATOR /-4232 M900-1002	06215213	1	1001519	4014486460384

DEUTZ-FAHR M 900



8	COUNTERSHAFT - GRAIN TANK	06212924	1	1002211	4014486477627
8	STRAW CUTTER	06211006	1	1003550	4014486471908
9	TENSION ARM /M900+2660.M922+2706.M1002+2827	06210991	1	1000660	4014486470246
9	TENSION ARM /M900-2659.M922-2530.M1002-2826	06212925	1	1003686	4014486477757
10	RETURN ELEVATOR DRIVE	06210991	1	1000660	4014486470246
10	TRACTION DRIVE	06215213	1	1001519	4014486460384
10	RETURN ELEVATOR DRIVE	06212925	1	1003686	4014486477757
11	COUNTERSHAFT - STRAW STRIPPER DRUM	06215250	1	1001833	4014486488562
11	TANK	06212924	1	1002211	4014486477627
12	ELEVATOR DRIVE GRAIN	06210921	1	1000356	4014486466133
12	STRAW DISTRIBUTOR	06212925	1	1003686	4014486477757
13	CHOPPER DRIVE	06211001	1	1000751	4014486471496
13	RETURN DRIVE	06212925	1	1003686	4014486477757
14	VENTILATOR	06215197	1	1001066	4014486496505
14	CHOPPER DRIVE	06211006	1	1003550	4014486471908
15	REEL DRIVE VARIABLE SPEED	06215217	1	1001157	4014486497366

DEUTZ-FAHR M 922

No.	Application	OEM - PN	Set	Optibelt AP-Nr.	EAN
	ALTERNATOR DRIVE (ENGINE) / -2280 M980/922	01168304	1	1000018	4014486483352
	BLOWER DRIVE (ENGINE) / M900/922	02235531	1	1002475	4014486493627
1	BLADE CONTROL	06212919	1	1000463	4014486467338
1	ENGINE - COUNTERSHAFT / M900/922/980/1080	06215236	1	1001679	4014486486483
2	ELEVATOR DRIVE UNIT	06210921	1	1000356	4014486466133
2	COUNTERSHAFT - FAN DRIVE	06215197	1	1001066	4014486496505
3	THRESHING DRUM VARIATOR DRIVE	06215220	1	1001222	4014486497779
3	ENGINE DRIVE	06215236	1	1001679	4014486486483
4	REEL DRIVE VARIABLE SPEED	06215217	1	1001157	4014486497366
4	STRAW SPREADER DRIVE	06215250	1	1001833	4014486488562
5	SHAFT KNIFE DRIVE	06212919	1	1000463	4014486467338
5	ENGINE DRIVE	06215237	1	1003655	4014486489651
6	PLATFORM FEED CHANNEL	06210989	1	1003526	4014486470086
6	STRAW DISTRIBUTOR	06210989	1	1003526	4014486470086
7	STRAW CUTTER	06211001	1	1000751	4014486471496
7	COUNTERSHAFT - TRAVEL SPEED VARIATOR /-4232 M900-1002	06215213	1	1001519	4014486460384
7	COUNTERSHAFT - TRAVEL SPEED VARIATOR /+4233 M980/1080	06215215	1	1001520	4014486460391
8	COUNTERSHAFT - GRAIN TANK	06212924	1	1002211	4014486477627

DEUTZ-FAHR M 922



8	STRAW CUTTER	06211006	1	1003550	4014486471908
9	TENSION ARM /M900+2660.M922+2706.M1002+2827	06210991	1	1000660	4014486470246
9	TENSION ARM /M900-2659.M922-2530.M1002-2826	06212925	1	1003686	4014486477757
10	RETURN ELEVATOR DRIVE	06210991	1	1000660	4014486470246
10	TRACTION DRIVE	06215213	1	1001519	4014486460384
10	RETURN ELEVATOR DRIVE	06212925	1	1003686	4014486477757
11	COUNTERSHAFT - STRAW STRIPPER DRUM	06215250	1	1001833	4014486488562
11	TANK	06212924	1	1002211	4014486477627
12	ELEVATOR DRIVE GRAIN	06210921	1	1000356	4014486466133
12	STRAW DISTRIBUTOR	06212925	1	1003686	4014486477757
13	CHOPPER DRIVE	06211001	1	1000751	4014486471496
13	RETURN DRIVE	06212925	1	1003686	4014486477757
14	VENTILATOR	06215197	1	1001066	4014486496505
14	CHOPPER DRIVE	06211006	1	1003550	4014486471908
15	REEL DRIVE VARIABLE SPEED	06215217	1	1001157	4014486497366
16	BEATER DRIVE	06215217	1	1001157	4014486497366

DEUTZ-FAHR POWERLINER 4030



No.	Application	OEM - PN	Set	Optibelt AP-Nr.	EAN
1		06215217	1	1001157	4014486497366
2		02235254	1	1002483	4014486493801
3		01145263	1	1000407	4014486466706
4		01145262	1	1001595	4014486485141
5		06215239	1	1001601	4014486485233
6		01145260	1	1001612	4014486485400
7		01141816	1	1001630	4014486485738
8		01145226	1	1001657	4014486486117
9		01145261	1	1001827	4014486488487
10		06215258	1	1001912	4014486489750
11		01141917	1	1000659	4014486470239
12		01145224	1	1001072	4014486496567
13		01141971	1	1001224	4014486497793

DEUTZ-FAHR POWERLINER 4035



No.	Application	OEM - PN	Set	Optibelt AP-Nr.	EAN
1		06215217	1	1001157	4014486497366
2		02235254	1	1002483	4014486493801
3		01145263	1	1000407	4014486466706
4		01145262	1	1001595	4014486485141
5		06215239	1	1001601	4014486485233
6		01145260	1	1001612	4014486485400
7		01141816	1	1001630	4014486485738
8		01145226	1	1001657	4014486486117
9		01145261	1	1001827	4014486488487
10		06215258	1	1001912	4014486489750
11		01141917	1	1000659	4014486470239
12		01145224	1	1001072	4014486496567
13		01141971	1	1001224	4014486497793

DEUTZ-FAHR STARLINER 4040



No.	Application	OEM - PN	Set	Optibelt AP-Nr.	EAN
1		06256714	3	1002763	4014486464290
2		06256546	3	1002759	4014486465013
3		06256619	2	1002762	4014486465570
4		01141608	1	1001637	4014486485868
5		01141941	1	1001865	4014486489057
6		01141591	1	1001902	4014486489620
7		01141666	1	1000794	4014486472134
8		01141613	1	1001749	4014486487329
9		06215244	1	1001787	4014486487756
10		06215222	1	1001223	4014486497786
11		01145318	1	1002046	4014486475227
12		01139241	1	1002193	4014486477412
13		01141645	1	1003620	4014486486957
14		01145331	1	1001075	4014486496598
15		02235180	1	1002462	4014486493467
16		06210890	1	1003410	4014486463477
18		06257898	2	1002911	4014486470666

DEUTZ-FAHR STARLINER 4045



No.	Application	OEM - PN	Set	Optibelt AP-Nr.	EAN
1		06256714	3	1002763	4014486464290
2		06256546	3	1002759	4014486465013
3		06256619	2	1002762	4014486465570
4		01141608	1	1001637	4014486485868
5		01141941	1	1001865	4014486489057
6		01141591	1	1001902	4014486489620
7		01141666	1	1000794	4014486472134
8		01141613	1	1001749	4014486487329
9		06215244	1	1001787	4014486487756
10		06215222	1	1001223	4014486497786
11		01145318	1	1002046	4014486475227
12		01139241	1	1002193	4014486477412
13		01141645	1	1003620	4014486486957
14		01145331	1	1001075	4014486496598
15		02235180	1	1002462	4014486493467
16		06210890	1	1003410	4014486463477
18		06257898	2	1002911	4014486470666

DEUTZ-FAHR TOPLINER 4060

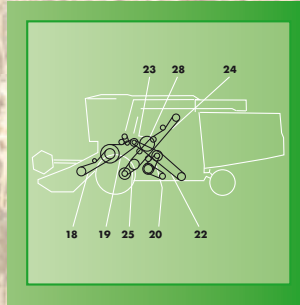
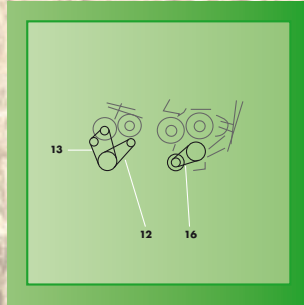
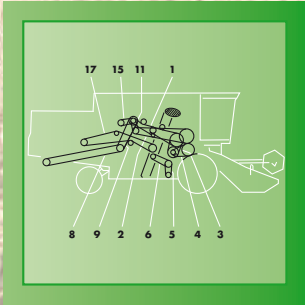

No.	Application	OEM - PN	Set	Optibelt AP-Nr.	EAN
1	ENGINE - STRAW STRIPPER DRUM	01145050	1	1001917	4014486489835
2	ENGINE - GRAIN TANK EMPTYING	01145055	1	1000825	4014486472516
3	THRESHING DRUM VARIATOR DRIVE	01145026	1	1001541	4014486460605
4	COUNTERSHAFT - THRESHING DRUM	01145049	1	1000317	4014486465341
5	FAN DRIVE VARIABLE SPEED - CLEANING FAN	01145097	1	1001068	4014486496529
6	STRAW WALKER - VARIATOR	01145202	1	1001070	4014486496543
8	FOR STRAW CHOPPER INTEGRATED	01145188	1	1001716	4014486486971
8	FOR STRAW CHOPPER INTEGRATED	01145187	1	1001740	4014486487244
9	ENGINE - CHOPPER TRANSMISSION	06257898	2	1002911	4014486470666
11	ENGINE - GRAIN TANK CLUTCH	01141613	1	1001749	4014486487329
12	ALTERNATOR DRIVE	02235180	1	1002462	4014486493467
13	BLOWER DRIVE	02234343	2	1002485	4014486493856
13	BLOWER DRIVE	02235177	2	1002487	4014486493894
17	STRAW WALKER DRIVE	01145054	1	1000427	4014486466904

DEUTZ-FAHR TOPLINER 4060

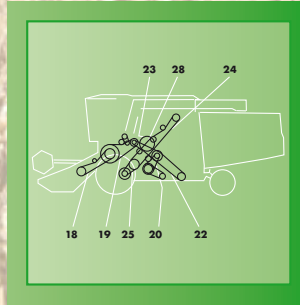
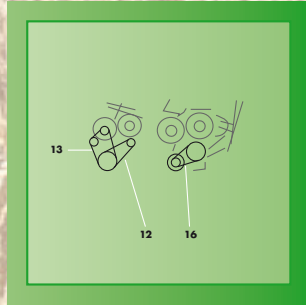
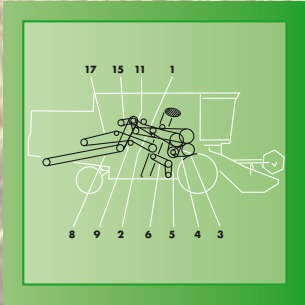

17	STRAW WALKER DRIVE	01145053	1	1000434	4014486467017
18	CUTTING TABLE DRIVE	01145211	2	1000768	4014486471755
18	PICKING - ATTACHMENTS DRIVE (MAIZE)	01145025	1	1001779	4014486520378
18	CUTTING TABLE DRIVE	01143412	2	1002909	4014486471779
19	STRAW STRIPPER DRUM - FEED CHANNEL	01141608	1	1001637	4014486485868
19	EQUIPMENT (MAIZE)	01141941	1	1001865	4014486489057
20	SHAKER SHOE - WALKER TRANSMISSION	01143413	3	1002852	4014486464498
21	STRAW STRIPPER DRUM - WALKER TRANSMISSION	01145051	2	1000333	4014486465723
22	RETURN ELEVATOR - WALKER TRANSMISSION	01145052	1	1000350	4014486466065
23	STRAW SHIPPER DRUM - TURBO - SEPARATOR	01143410	2	1002835	4014486463668
24	ENGINE - COUNTERSHAFT	01145102	1	1001788	4014486487763
25	TRAVEL SPEED VARIATOR	01141944	1	1001226	4014486497816

DEUTZ-FAHR TOPLINER 4065

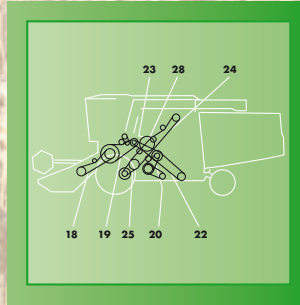
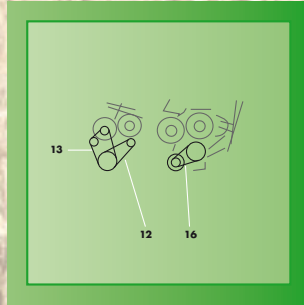
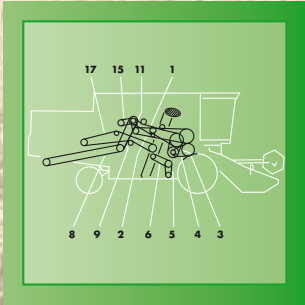

No.	Application	OEM - PN	Set	Optibelt AP-Nr.	EAN
1	ENGINE - STRAW STRIPPER DRUM	01145050	1	1001917	4014486489835
2	ENGINE - GRAIN TANK EMPTYING	01145055	1	1000825	4014486472516
3	THRESHING DRUM VARIATOR DRIVE	01145026	1	1001541	4014486460605
4	COUNTERSHAFT - THRESHING DRUM	01145049	1	1000317	4014486465341
5	FAN DRIVE VARIABLE SPEED - CLEANING FAN	01145097	1	1001068	4014486496529
6	STRAW WALKER - VARIATOR	01145202	1	1001070	4014486496543
8	FOR STRAW CHOPPER INTEGRATED	01145188	1	1001716	4014486486971
8	FOR STRAW CHOPPER INTEGRATED	01145187	1	1001740	4014486487244
9	ENGINE - CHOPPER TRANSMISSION	06257898	2	1002911	4014486470666
11	ENGINE - GRAIN TANK CLUTCH	01141613	1	1001749	4014486487329
12	ALTERNATOR DRIVE	02235180	1	1002462	4014486493467
13	BLOWER DRIVE	02234343	2	1002485	4014486493856
13	BLOWER DRIVE	02235177	2	1002487	4014486493894
17	STRAW WALKER DRIVE	01145054	1	1000427	4014486466904

DEUTZ-FAHR TOPLINER 4065

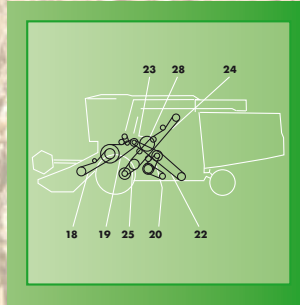
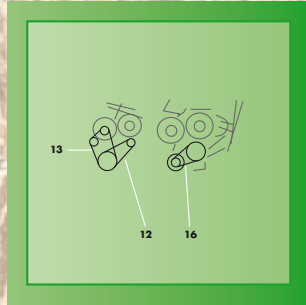
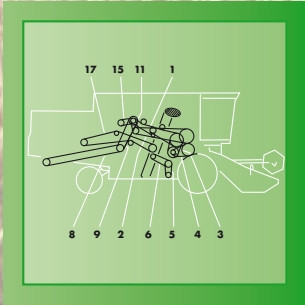

17	STRAW WALKER DRIVE	01145053	1	1000434	4014486467017
18	CUTTING TABLE DRIVE	01145211	2	1000768	4014486471755
18	PICKING - ATTACHMENTS DRIVE (MAIZE)	01145025	1	1001779	4014486520378
18	CUTTING TABLE DRIVE	01143412	2	1002909	4014486471779
19	STRAW STRIPPER DRUM - FEED CHANNEL	01141608	1	1001637	4014486485868
19	EQUIPMENT (MAIZE)	01141941	1	1001865	4014486489057
20	SHAKER SHOE - WALKER TRANSMISSION	01143413	3	1002852	4014486464498
21	STRAW STRIPPER DRUM - WALKER TRANSMISSION	01145051	2	1000333	4014486465723
22	RETURN ELEVATOR - WALKER TRANSMISSION	01145052	1	1000350	4014486466065
23	STRAW SHIPPER DRUM - TURBO - SEPARATOR	01143410	2	1002835	4014486463668
24	ENGINE - COUNTERSHAFT	01145102	1	1001788	4014486487763
25	TRAVEL SPEED VARIATOR	01141944	1	1001226	4014486497816

DEUTZ-FAHR TOPLINER 4070

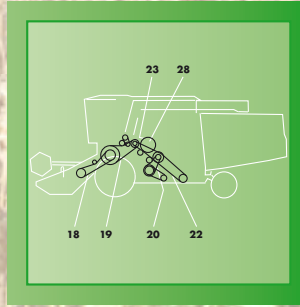
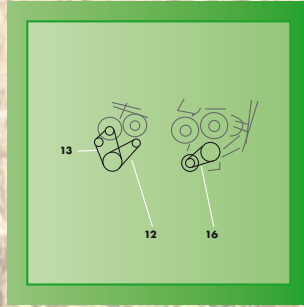
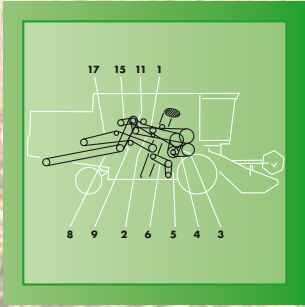

No.	Application	OEM - PN	Set	Optibelt AP-Nr.	EAN
1	STRAW STRIPPER DRUM	01145057	1	1001269	4014486492354
1	STRAW STRIPPER DRUM	01145056	1	1002028	4014486491630
2	ENGINE - GRAIN TANK EMPTYING	01145055	1	1000825	4014486472516
3	THRESHING DRUM VARIATOR DRIVE	01145374	1	1001541	4014486460605
4	COUNTERSHAFT - THRESHING DRUM	01145049	1	1000317	4014486465341
5	FAN DRIVE VARIABLE SPEED - CLEANING FAN	01145332	1	1001073	4014486496574
5	FAN DRIVE VARIABLE SPEED - CLEANING FAN	01145369	1	1001074	4014486496581
6	STRAW WALKER - VARIATOR	01145331	1	1001075	4014486496598
8	CHOPPER DRIVE	01145188	1	1001716	4014486486971
8	CHOPPER DRIVE	01145187	1	1001740	4014486487244
9	CHOPPER DRIVE	01145475	2	1000689	4014486470673
9	CHOPPER DRIVE	01145479	1	1001767	4014486487510
11	CLUTCH GRAIN TANK	01141613	1	1001749	4014486487329
12	ALTERNATOR DRIVE FOR 4070/4075	02235180	1	1002462	4014486493467

DEUTZ-FAHR TOPLINER 4070

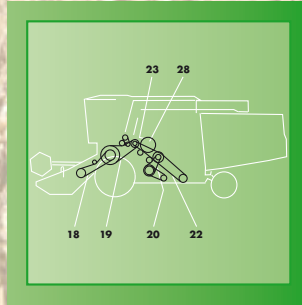
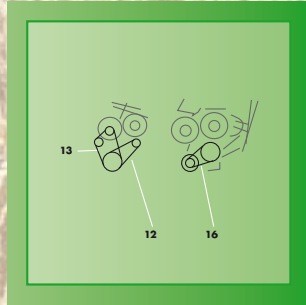
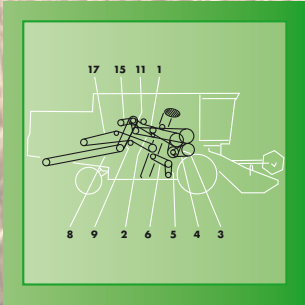

13	BLOWER DRIVE FOR 4070/4075	02235177	2	1002487	4014486493894
15	COOLING PLANT	01145318	1	1002046	4014486475227
17	STRAW WALKER DRIVE	01145054	1	1000427	4014486466904
17	STRAW WALKER DRIVE	01145053	1	1000434	4014486467017
18	CUTTING TABLE DRIVE	01145025	1	1001779	4014486520378
19	FEEDER CHANNEL	01145329	1	1001863	4014486489026
19	FEEDER CHANNEL	01141941	1	1001865	4014486489057
20	SHAKER SHOE DRIVE	01143413	3	1002852	4014486464498
22	RETURN ELEVATOR DRIVE	01145052	1	1000350	4014486466065
23	STRAW STRIPPER DRUM	01143410	2	1002835	4014486463668
24	STRAW STRIPPER DRUM	01145051	2	1000333	4014486465723

DEUTZ-FAHR TOPLINER 4075

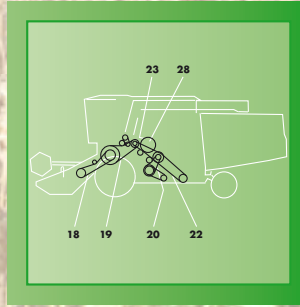
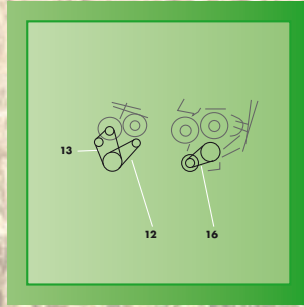
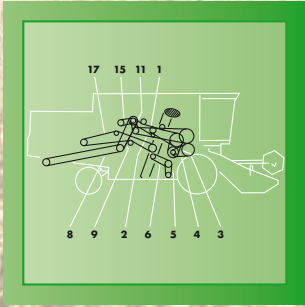

No.	Application	OEM - PN	Set	Optibelt AP-Nr.	EAN
1	STRAW STRIPPER DRUM	01145057	1	1001269	4014486492354
1	STRAW STRIPPER DRUM	01145056	1	1002028	4014486491630
2	ENGINE - GRAIN TANK EMPTYING	01145055	1	1000825	4014486472516
3	THRESHING DRUM VARIATOR DRIVE	01145374	1	1001541	4014486460605
4	COUNTERSHAFT - THRESHING DRUM	01145049	1	1000317	4014486465341
5	FAN DRIVE VARIABLE SPEED - CLEANING FAN	01145332	1	1001073	4014486496574
5	FAN DRIVE VARIABLE SPEED - CLEANING FAN	01145369	1	1001074	4014486496581
6	STRAW WALKER - VARIATOR	01145331	1	1001075	4014486496598
8	CHOPPER DRIVE	01145188	1	1001716	4014486486971
8	CHOPPER DRIVE	01145187	1	1001740	4014486487244
9	CHOPPER DRIVE	01145475	2	1000689	4014486470673
9	CHOPPER DRIVE	01145479	1	1001767	4014486487510
11	CLUTCH GRAIN TANK	01141613	1	1001749	4014486487329
12	ALTERNATOR DRIVE FOR 4070/4075	02235180	1	1002462	4014486493467

DEUTZ-FAHR TOPLINER 4075

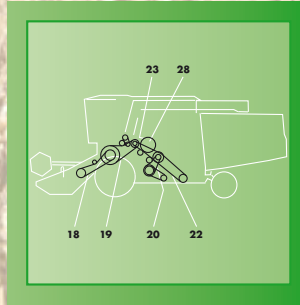
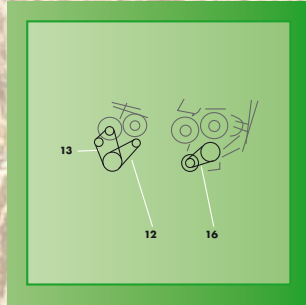
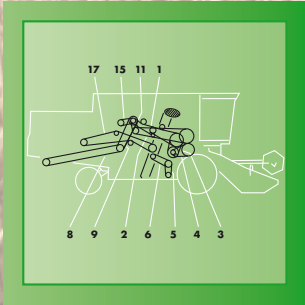

13	BLOWER DRIVE FOR 4070/4075	02235177	2	1002487	4014486493894
15	COOLING PLANT	01145318	1	1002046	4014486475227
16	ALTERNATOR DRIVE FOR 4075/4080/4090	02237477	1	1002452	4014486493337
17	STRAW WALKER DRIVE	01145054	1	1000427	4014486466904
17	STRAW WALKER DRIVE	01145053	1	1000434	4014486467017
18	CUTTING TABLE DRIVE	01145025	1	1001779	4014486520378
19	FEEDER CHANNEL	01145329	1	1001863	4014486489026
19	FEEDER CHANNEL	01141941	1	1001865	4014486489057
20	SHAKER SHOE DRIVE	01143413	3	1002852	4014486464498
22	RETURN ELEVATOR DRIVE	01145052	1	1000350	4014486466065
23	STRAW STRIPPER DRUM	01143410	2	1002835	4014486463668
24	STRAW STRIPPER DRUM	01145051	2	1000333	4014486465723

DEUTZ-FAHR TOPLINER 4080

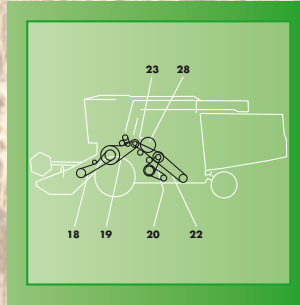
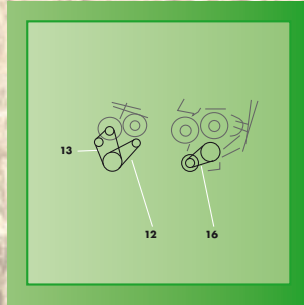
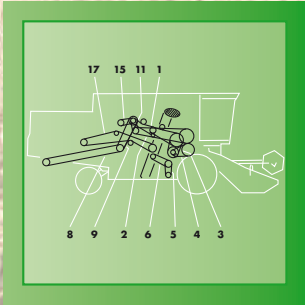

No.	Application	OEM - PN	Set	Optibelt AP-Nr.	EAN
1	STRAW STRIPPER DRUM	01145057	1	1001269	4014486492354
1	STRAW STRIPPER DRUM	01145056	1	1002028	4014486491630
2	ENGINE - GRAIN TANK EMPTYING	01145055	1	1000825	4014486472516
3	THRESHING DRUM VARIATOR DRIVE	01145374	1	1001541	4014486460605
4	COUNTERSHAFT - THRESHING DRUM	01145049	1	1000317	4014486465341
5	FAN DRIVE VARIABLE SPEED - CLEANING FAN	01145332	1	1001073	4014486496574
5	FAN DRIVE VARIABLE SPEED - CLEANING FAN	01145369	1	1001074	4014486496581
6	STRAW WALKER - VARIATOR	01145331	1	1001075	4014486496598
8	CHOPPER DRIVE	01145188	1	1001716	4014486486971
8	CHOPPER DRIVE	01145187	1	1001740	4014486487244
9	CHOPPER DRIVE	01145475	2	1000689	4014486470673
9	CHOPPER DRIVE	01145479	1	1001767	4014486487510

DEUTZ-FAHR TOPLINER 4080

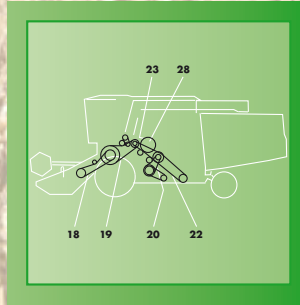
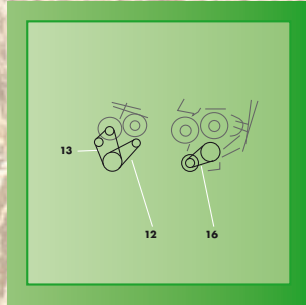
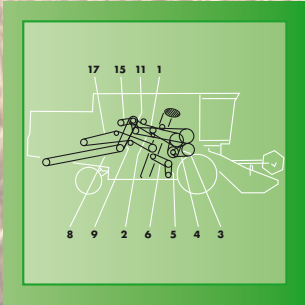

11	CLUTCH GRAIN TANK	01141613	1	1001749	4014486487329
15	COOLING PLANT	01145318	1	1002046	4014486475227
16	ALTERNATOR DRIVE FOR 4075/4080/4090	02237477	1	1002452	4014486493337
17	STRAW WALKER DRIVE	01145054	1	1000427	4014486466904
17	STRAW WALKER DRIVE	01145053	1	1000434	4014486467017
18	CUTTING TABLE DRIVE	01145025	1	1001779	4014486520378
19	FEEDER CHANNEL	01145329	1	1001863	4014486489026
19	FEEDER CHANNEL	01141941	1	1001865	4014486489057
20	SHAKER SHOE DRIVE	01143413	3	1002852	4014486464498
22	RETURN ELEVATOR DRIVE	01145052	1	1000350	4014486466065
23	STRAW STRIPPER DRUM	01143410	2	1002835	4014486463668
24	STRAW STRIPPER DRUM	01145051	2	1000333	4014486465723

DEUTZ-FAHR TOPLINER 4090

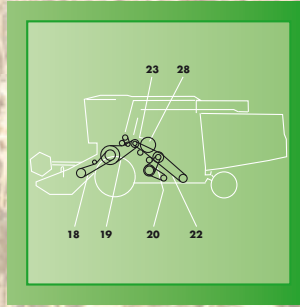
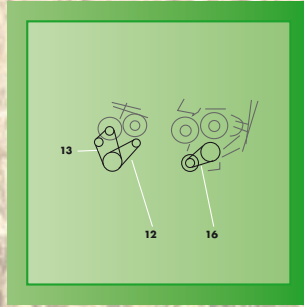
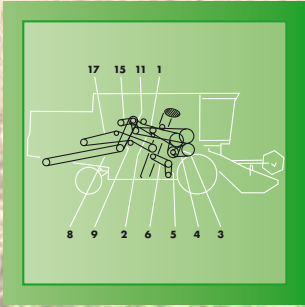

No.	Application	OEM - PN	Set	Optibelt AP-Nr.	EAN
1	STRAW STRIPPER DRUM	01145057	1	1001269	4014486492354
1	STRAW STRIPPER DRUM	01145056	1	1002028	4014486491630
2	ENGINE - GRAIN TANK EMPTYING	01145055	1	1000825	4014486472516
3	THRESHING DRUM VARIATOR DRIVE	01145374	1	1001541	4014486460605
4	COUNTERSHAFT - THRESHING DRUM	01145049	1	1000317	4014486465341
5	FAN DRIVE VARIABLE SPEED - CLEANING FAN	01145332	1	1001073	4014486496574
5	FAN DRIVE VARIABLE SPEED - CLEANING FAN	01145369	1	1001074	4014486496581
6	STRAW WALKER - VARIATOR	01145331	1	1001075	4014486496598
8	CHOPPER DRIVE	01145188	1	1001716	4014486486971
8	CHOPPER DRIVE	01145187	1	1001740	4014486487244
9	CHOPPER DRIVE	01145475	2	1000689	4014486470673
9	CHOPPER DRIVE	01145479	1	1001767	4014486487510

DEUTZ-FAHR TOPLINER 4090

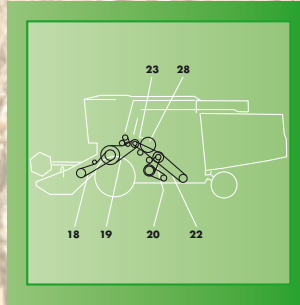
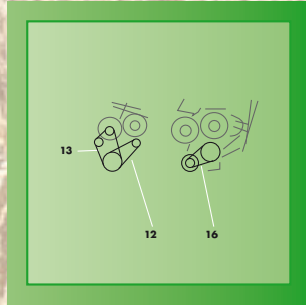
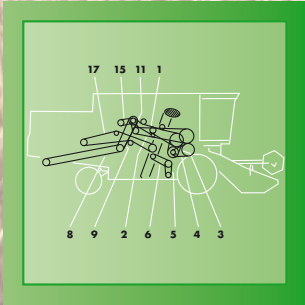

11	CLUTCH GRAIN TANK	01141613	1	1001749	4014486487329
15	COOLING PLANT	01145318	1	1002046	4014486475227
16	ALTERNATOR DRIVE FOR 4075/4080/4090	02237477	1	1002452	4014486493337
17	STRAW WALKER DRIVE	01145054	1	1000427	4014486466904
17	STRAW WALKER DRIVE	01145053	1	1000434	4014486467017
18	CUTTING TABLE DRIVE	01145025	1	1001779	4014486520378
19	FEEDER CHANNEL	01145329	1	1001863	4014486489026
19	FEEDER CHANNEL	01141941	1	1001865	4014486489057
20	SHAKER SHOE DRIVE	01143413	3	1002852	4014486464498
22	RETURN ELEVATOR DRIVE	01145052	1	1000350	4014486466065
23	STRAW STRIPPER DRUM	01143410	2	1002835	4014486463668
24	STRAW STRIPPER DRUM	01145051	2	1000333	4014486465723

DEUTZ-FAHR TOPLINER 8XL



No.	Application	OEM - PN	Set	Optibelt AP-Nr.	EAN
1		01145744	1	1001309	4014486492699
5		01145633	1	1000799	4014486472189
6		01145699	1	1000564	4014486468694
7		01145792	1	1000770	4014486471762
8		01145823	1	1002090	4014486475838
10		01145921	1	1000042	4014486460797
11		01145742	1	1001299	4014486492521
12		01145960	3	1002755	4014486463323
13		01145789	2	1004094	4014486520019
14		01145332	1	1001073	4014486496574
15		01145724	1	1001076	4014486496604
18		01145865	1	1001991	4014486491111
19		01145866	1	1001926	4014486489941
21		01141643	1	1000735	4014486471311
22		01145959	2	1002849	4014486463910
24		01141904	1	1001457	4014486459654

DRONNINGBORG D 1200



BISO - Schrattecker
BIZON
CASE INTL. HARVESTER
CLAAS
DEUTZ-FAHR
DRONNINGBORG
FENDT
FORTSCHRITT
JOHN DEERE
KRONE
LAVERDA
MASSEY FERGUSON
NEW HOLLAND
ROSTSELMASH

No.	Application	OEM - PN	Set	Optibelt AP-Nr.	EAN
1	FILLING ELEVATOR	41935700	1	1003447	4014486465464
3	ELEVATOR - RETURN ELEVATOR GRAIN	41932600	1	1000289	4014486464757
6	DRIVING GEAR	41996300	1	1002205	4014486477566
7	AWNER SHAFT	41974300	1	1001357	4014486474718
8	STRAW SHAKER	41966500	1	1003444	4014486465235
10	FEEDER SHAFT (UPPER)	41937300	1	1000339	4014486520217
11	KNIFE DRIVE	41964400	1	1003409	4014486463415
12	FEEDER AUGER	41953700	1	1003505	4014486469196
13	HYDRAULIC DRIVE VARIATOR	41996500	1	1002150	4014486476682
15	SPRING LOADED DRIVE VARIATOR	41994300	1	1001215	4014486497748
16	STRAW GUIDE	41926100	1	1000224	4014486462913
20	STRAW GUIDE	41996100	1	1002080	4014486475708
21	MAIN FAN VARIABLE SPEED DRIVE	41928100	1	1003415	4014486463637
22	MAIN FAN	41930300	1	1003426	4014486464092
24	FEEDER SHAFT (UPPER)	41954800	1	1003537	4014486470611

DRONNINGBORG D 1250



No.	Application	OEM - PN	Set	Optibelt AP-Nr.	EAN
1	FILLING ELEVATOR	41935700	1	1003447	4014486465464
3	ELEVATOR - RETURN ELEVATOR GRAIN	41932600	1	1000289	4014486464757
6	DRIVING GEAR	41996300	1	1002205	4014486477566
7	AWNER SHAFT	41974300	1	1001357	4014486474718
8	STRAW SHAKER	41966500	1	1003444	4014486465235
10	FEEDER SHAFT (UPPER)	41937300	1	1000339	4014486520217
11	KNIFE DRIVE	41964400	1	1003409	4014486463415
12	FEEDER AUGER	41953700	1	1003505	4014486469196
13	HYDRAULIC DRIVE VARIATOR	41996500	1	1002150	4014486476682
15	SPRING LOADED DRIVE VARIATOR	41994300	1	1001215	4014486497748
16	STRAW GUIDE	41926100	1	1000224	4014486462913
20	STRAW GUIDE	41996100	1	1002080	4014486475708
21	MAIN FAN VARIABLE SPEED DRIVE	41928100	1	1003415	4014486463637
22	MAIN FAN	41930300	1	1003426	4014486464092
24	FEEDER SHAFT (UPPER)	41954800	1	1003537	4014486470611

DRONNINGBORG D 1500



No.	Application	OEM - PN	Set	Optibelt AP-Nr.	EAN
1	FAN DRIVE	41928100	1	1003415	4014486463637
2	COUNTERSHAFT DRIVE	41996400	1	1002071	4014486475579
4	FAN DRIVE	41974300	1	1001357	4014486474718
6	HYDRAULIC DRIVE VARIATOR	41996500	1	1002150	4014486476682
7	GEAR BOX	41994300	1	1001215	4014486497748
10	SHAKER SHAFT DRIVE	41966900	1	1003449	4014486465501
11	FILLING AUGER	41997600	1	1002197	4014486477467
14	FEEDER AUGER	41953700	1	1003505	4014486469196
22	THRESHING DRUM VARIATOR DRIVE	41981900	1	1000570	4014486468786
29	CRANK PULLEY	41964400	1	1003409	4014486463415

DRONNINGBORG D 1600



No.	Application	OEM - PN	Set	Optibelt AP-Nr.	EAN
1	FILLING ELEVATOR	41935700	1	1003447	4014486465464
3	ELEVATOR - RETURN ELEVATOR GRAIN	41932600	1	1000289	4014486464757
6	DRIVING GEAR	41996300	1	1002205	4014486477566
7	AWNER SHAFT	41974300	1	1001357	4014486474718
8	STRAW SHAKER	41966500	1	1003444	4014486465235
10	FEEDER SHAFT (UPPER)	41937300	1	1000339	4014486520217
11	KNIFE DRIVE	41964400	1	1003409	4014486463415
12	FEEDER AUGER	41953700	1	1003505	4014486469196
13	HYDRAULIC DRIVE VARIATOR	41996500	1	1002150	4014486476682
15	SPRING LOADED DRIVE VARIATOR	41994300	1	1001215	4014486497748
16	STRAW GUIDE	41926100	1	1000224	4014486462913
20	STRAW GUIDE	41996100	1	1002080	4014486475708
21	MAIN FAN VARIABLE SPEED DRIVE	41928100	1	1003415	4014486463637
22	MAIN FAN	41930300	1	1003426	4014486464092
24	FEEDER SHAFT (UPPER)	41954800	1	1003537	4014486470611

DRONNINGBORG D 1650



BISO - Schrattecker
BIZON
CASE INTL. HARVESTER
CLAAS
DEUTZ-FAHR
DRONNINGBORG
FENDT
FORTSCHRITT
JOHN DEERE
KRONE
LAVERDA
MASSEY FERGUSON
NEW HOLLAND
ROSTSELMASH

No.	Application	OEM - PN	Set	Optibelt AP-Nr.	EAN
1	FILLING ELEVATOR	41935700	1	1003447	4014486465464
3	ELEVATOR - RETURN ELEVATOR GRAIN	41932600	1	1000289	4014486464757
6	DRIVING GEAR	41996300	1	1002205	4014486477566
7	AWNER SHAFT	41974300	1	1001357	4014486474718
8	STRAW SHAKER	41966500	1	1003444	4014486465235
10	FEEDER SHAFT (UPPER)	41937300	1	1000339	4014486520217
11	KNIFE DRIVE	41964400	1	1003409	4014486463415
12	FEEDER AUGER	41953700	1	1003505	4014486469196
13	HYDRAULIC DRIVE VARIATOR	41996500	1	1002150	4014486476682
15	SPRING LOADED DRIVE VARIATOR	41994300	1	1001215	4014486497748
16	STRAW GUIDE	41926100	1	1000224	4014486462913
20	STRAW GUIDE	41996100	1	1002080	4014486475708
21	MAIN FAN VARIABLE SPEED DRIVE	41928100	1	1003415	4014486463637
22	MAIN FAN	41930300	1	1003426	4014486464092
24	FEEDER SHAFT (UPPER)	41954800	1	1003537	4014486470611

DRONNINGBORG D 1800



No.	Application	OEM - PN	Set	Optibelt AP-Nr.	EAN
1	FAN DRIVE	41928100	1	1003415	4014486463637
2	COUNTERSHAFT DRIVE	41996400	1	1002071	4014486475579
4	FAN DRIVE	41974300	1	1001357	4014486474718
6	HYDRAULIC DRIVE VARIATOR	41996500	1	1002150	4014486476682
7	GEAR BOX	41994300	1	1001215	4014486497748
10	SHAKER SHAFT DRIVE	41966900	1	1003449	4014486465501
11	FILLING AUGER	41997600	1	1002197	4014486477467
14	FEEDER AUGER	41953700	1	1003505	4014486469196
22	THRESHING DRUM VARIATOR DRIVE	41981900	1	1000570	4014486468786
29	CRANK PULLEY	41964400	1	1003409	4014486463415

DRONNINGBORG D 1900



No.	Application	OEM - PN	Set	Optibelt AP-Nr.	EAN
1		41983500	1	1000611	4014486469493
2		41964300	1	1003405	4014486463309
5		41950600	1	1003524	4014486469998
6		41950900	1	1000600	4014486469325
9		41987200	1	1003518	4014486469714
10		41935200	1	1000318	4014486465372
12		41928900	1	1000249	4014486463828
13		41942100	1	1000404	4014486466676
14		41987300	1	1000815	4014486472400
18		41935900	1	1000328	4014486465587
19		41950400	1	1003517	4014486469691
20		41929200	1	1003424	4014486463996

BISO - Schrattecker
 BIZON
 CASE INTL. HARVESTER
 CLAAS
 DEUTZ-FAHR
 DRONNINGBORG
 FENDT
 FORTSCHRITT
 JOHN DEERE
 KRONE
 LAVERDA
 MASSEY FERGUSON
 NEW HOLLAND
 ROSTSELMASH

DRONNINGBORG D 2250

No.	Application	OEM - PN	Set	Optibelt AP-Nr.	EAN
1	FEEDER AUGER	41983500	1	1000611	4014486469493
1	FEEDER AUGER	41983500	1	1000611	4014486469493
2	COUNTERSHAFT DRIVE	41964300	1	1003405	4014486463309
2	KNIFE DRIVE	41964300	1	1003405	4014486463309
3	FEEDER SHAFT (UPPER)	41955400	1	1000724	4014486471168
3	COUNTERSHAFT DRIVE	41955400	1	1000724	4014486471168
5	ELEVATOR DRIVE GRAIN	41954100	1	1000645	4014486470055
5	ECCENTRIC SHAFT DRIVE	41982200	1	1003499	4014486469004
6	CENTER SHAFT	41987100	1	1000602	4014486469349
6	STRAW SHAKER - RETURN AUGER	41989900	1	1001375	4014486474893
7	INTERMEDIATE SHAFT	41950000	1	1000625	4014486469738
7	ENGINE	41994600	1	1001845	4014486488746
9	STRAW GUIDE	41950000	1	1000625	4014486469738
9	COUNTERSHAFT DRIVE	41995600	1	1001822	4014486488401
10	HYDRAULIC PUMP DRIVE	41997200	1	1003676	4014486476460
11	RETURN AUGER DRIVE	41989900	1	1001375	4014486474893
11	COUNTER DRIVE	41999700	1	1002208	4014486477597
12	STRAW CUTTER	41999800	1	1002207	4014486477580
13	STRAW CHOPPER DRIVE	41940900	1	1000385	4014486466485
13	STRAW GUIDE - DISCHARGE AUGER	41995100	2	1000546	4014486468328
14	MAIN FAN	41957600	1	1000656	4014486470208
14	THRESHING DRUM VARIATOR DRIVE	41957800	1	1000706	4014486470925

DRONNINGBORG D 2250, D 2500



15	MAIN FAN	41950100	1	1000627	4014486469776
16	MAIN FAN VARIABLE SPEED DRIVE	41950200	1	1003539	4014486470727
17	MAIN FAN	41950300	3	1002859	4014486471007
1	FEEDER AUGER	41983500	1	1000611	4014486469493
2	KNIFE DRIVE	41964300	1	1003405	4014486463309
3	COUNTERSHAFT DRIVE	41955400	1	1000724	4014486471168
5	ECCENTRIC SHAFT DRIVE	41982200	1	1003499	4014486469004
6	STRAW SHAKER - RETURN AUGER	41989900	1	1001375	4014486474893
7	INTERMEDIATE SHAFT	41950000	1	1000625	4014486469738
9	COUNTERSHAFT DRIVE	41995600	1	1001822	4014486488401
10	HYDRAULIC PUMP DRIVE	41997200	1	1003676	4014486476460
11	COUNTER DRIVE STRAW CHOPPER	41999700	1	1002208	4014486477597
12	STRAW CUTTER	41999800	1	1002207	4014486477580
13	STRAW GUIDE - DISCHARGE AUGER	41995100	2	1000546	4014486468328
14	THRESHING DRUM VARIATOR DRIVE	41957800	1	1000706	4014486470925
16	MAIN FAN VARIABLE SPEED DRIVE	41950200	1	1003539	4014486470727
17	MAIN FAN	41950300	3	1002859	4014486471007

DRONNINGBORG D 2600



No.	Application	OEM - PN	Set	Optibelt AP-Nr.	EAN
1	FEEDER AUGER	41983500	1	1000611	4014486469493
2	KNIFE DRIVE	41964300	1	1003405	4014486463309
2	KNIFE DRIVE	41964300	1	1003405	4014486463309
3	COUNTERSHAFT DRIVE	41955400	1	1000724	4014486471168
7	CENTER SHAFT	41950000	1	1000625	4014486469738
8	STRAW GUIDE	41986800	1	1000684	4014486470628
10	ENGINE	41997200	1	1003676	4014486476460
11	COUNTER DRIVE	41999700	1	1002208	4014486477597
12	STRAW CHOPPER DRIVE	41999800	1	1002207	4014486477580
14	THRESHING DRUM VARIATOR DRIVE	41957800	1	1000706	4014486470925
16	SELECTOR FOR MAIN FAN	41950200	1	1003539	4014486470727
17	MAIN FAN	41950300	3	1002859	4014486471007

DRONNINGBORG D 3000 S



No.	Application	OEM - PN	Set	Optibelt AP-Nr.	EAN
1	RETURN AUGER (UPPER)	41964300	1	1003405	4014486463309
1	RETURN AUGER (UPPER)	41964300	1	1003405	4014486463309
5	HYDRAULIC PUMP DRIVE	41924900	1	1003394	4014486462692
5	HYDRAULIC PUMP DRIVE	41924900	1	1003394	4014486462692
5	HYDRAULIC PUMP DRIVE	41924900	1	1003394	4014486462692
5	HYDRAULIC PUMP DRIVE	41924900	1	1003394	4014486462692
6	STRAW CHOPPER DRIVE	41986500	1	1000805	4014486472271
6	STRAW CHOPPER DRIVE	41986500	1	1000805	4014486472271
6	STRAW CHOPPER DRIVE	41986500	1	1000805	4014486472271
6	STRAW CHOPPER DRIVE	41986500	1	1000805	4014486472271
8	COUNTERSHAFT DRIVE	41992700	1	1000910	4014486473575
8	COUNTERSHAFT DRIVE	41992700	1	1000910	4014486473575
8	COUNTERSHAFT DRIVE	41992700	1	1000910	4014486473575
9	FEEDER SHAFT (UPPER)	41983900	1	1003521	4014486469882
9	FEEDER SHAFT (UPPER)	41983900	1	1003521	4014486469882
9	FEEDER SHAFT (UPPER)	41983900	1	1003521	4014486469882
9	FEEDER SHAFT (UPPER)	41983900	1	1003521	4014486469882
10	COUNTER DRIVE	41955900	1	1000704	4014486470888
10	COUNTER DRIVE STRAW CHOPPER	41955900	1	1000704	4014486470888
11	COUNTER DRIVE	41955900	1	1000704	4014486470888
11	COUNTER DRIVE STRAW CHOPPER	41955900	1	1000704	4014486470888
14	INTERMEDIATE SHAFT	41926600	1	1000235	4014486463361

DRONNINGBORG D 3000 S



No.	Application	OEM - PN	Set	Optibelt AP-Nr.	EAN
14	INTERMEDIATE SHAFT	41926600	1	1000235	4014486463361
14	INTERMEDIATE SHAFT	41926600	1	1000235	4014486463361
14	INTERMEDIATE SHAFT	41926600	1	1000235	4014486463361
15	ELEVATOR DRIVE GRAIN	41937600	1	1003450	4014486465600
15	STRIPPER BEATER	41937600	1	1003450	4014486465600
15	ELEVATOR DRIVE GRAIN	41937600	1	1003450	4014486465600
15	ELEVATOR DRIVE GRAIN	41937600	1	1003450	4014486465600
16	DISCHARGE AUGER SHAFT	41984300	1	1000898	4014486473414
16	DISCHARGE AUGER SHAFT	41984300	1	1000898	4014486473414
16	DISCHARGE AUGER SHAFT	41984300	1	1000898	4014486473414
17	ECCENTRIC SHAFT DRIVE	41926300	1	1000230	4014486463187
17	ECCENTRIC SHAFT DRIVE	41926300	1	1000230	4014486463187
17	ECCENTRIC SHAFT DRIVE	41926300	1	1000230	4014486463187
17	ECCENTRIC SHAFT DRIVE	41926300	1	1000230	4014486463187
18	MAIN FAN	41930300	1	1003426	4014486464092
18	MAIN FAN	41930300	1	1003426	4014486464092
18	MAIN FAN	41930300	1	1003426	4014486464092
18	MAIN FAN	41930300	1	1003426	4014486464092
19	AWNER SHAFT	41966500	1	1003444	4014486465235
19	MAIN FAN SELECTOR	41934900	1	1003445	4014486465303
19	MAIN FAN SELECTOR	41934900	1	1003445	4014486465303
19	ECCENTRIC SHAFT DRIVE	41934900	1	1003445	4014486465303

DRONNINGBORG D 3000 S, D 4000



BISO - Schrattecker
BIZON
CASE INTL. HARVESTER
CLAAS
DEUTZ-FAHR
DRONNINGBORG
FENDT
FORTSCHRITT
JOHN DEERE
KRONE
LAVERDA
MASSEY FERGUSON
NEW HOLLAND
ROSTSELMASH

19	ECCENTRIC SHAFT DRIVE	41934900	1	1003445	4014486465303
20	DISCHARGE AUGER SHAFT	41980300	1	1001439	4014486459470
20	STRIPPER BEATER	41980600	1	1001439	4014486459470
20	STRIPPER BEATER	41980600	1	1001439	4014486459470
1	STRIPPER BEATER	41964300	1	1003405	4014486463309
2	FILLING AUGER	41972200	1	1001353	4014486474664
2	FILLING AUGER	41972300	1	1001353	4014486474664
3	STRIPPER BEATER	41992200	1	1001653	4014486486063
3	STRIPPER BEATER	41992200	1	1001653	4014486486063
3	STRIPPER BEATER	41992200	1	1001653	4014486486063
4	HYDRAULIC PUMP DRIVE	41924900	1	1003394	4014486462692
4	HYDRAULIC PUMP DRIVE	41924900	1	1003394	4014486462692
4	HYDRAULIC PUMP DRIVE	41924900	1	1003394	4014486462692
5	PROPULSION PUMP DRIVE	41992100	1	1001643	4014486485950
5	PROPULSION PUMP DRIVE	41992100	1	1001643	4014486485950
5	PROPULSION PUMP DRIVE	41992100	1	1001643	4014486485950
6	STRAW CHOPPER DRIVE	41958500	1	1000859	4014486472936
6	STRAW CHOPPER DRIVE	41958500	1	1000859	4014486472936
6	STRAW CHOPPER DRIVE	41958500	1	1000859	4014486472936
7	FEEDER DRUM	41953700	1	1003505	4014486469196
8	COUNTERSHAFT DRIVE	41964400	1	1003409	4014486463415

DRONNINGBORG D 4000

No.	Application	OEM - PN	Set	Optibelt AP-Nr.	EAN
9	COUNTERSHAFT DRIVE	41992700	1	1000910	4014486473575
9	COUNTERSHAFT DRIVE	41992700	1	1000910	4014486473575
9	COUNTERSHAFT DRIVE	41992400	1	1000918	4014486473674
10	FEEDER SHAFT (UPPER)	41983900	1	1003521	4014486469882
10	FEEDER SHAFT (UPPER)	41983900	1	1003521	4014486469882
10	FEEDER SHAFT (UPPER)	41983900	1	1003521	4014486469882
11	COUNTER DRIVE STRAW CHOPPER	41955900	1	1000704	4014486470888
11	COUNTER DRIVE STRAW CHOPPER	41955900	1	1000704	4014486470888
11	COUNTER DRIVE STRAW CHOPPER	41955900	1	1000704	4014486470888
12	STRAW WALKER - ECCENTRIC	41972800	1	1001355	4014486474695
12	STRAW WALKER - ECCENTRIC	41972800	1	1001355	4014486474695
12	STRAW WALKER - ECCENTRIC	41972800	1	1001355	4014486474695
13	AWNER SHAFT - FAN SHAFT	41958500	1	1000859	4014486472936
13	AWNER SHAFT - FAN SHAFT	41978500	1	1001365	4014486474794
13	AWNER SHAFT - FAN SHAFT	41978500	1	1001365	4014486474794
14	INTERMEDIATE SHAFT	41926600	1	1000235	4014486463361
14	INTERMEDIATE SHAFT	41926600	1	1000235	4014486463361
14	INTERMEDIATE SHAFT	41926600	1	1000235	4014486463361
15	ELEVATOR DRIVE GRAIN	41937600	1	1003450	4014486465600
15	ELEVATOR DRIVE GRAIN	41937600	1	1003450	4014486465600
15	ELEVATOR DRIVE GRAIN	41937600	1	1003450	4014486465600
16	DISCHARGE AUGER SHAFT	41984300	1	1000898	4014486473414

DRONNINGBORG D 4000, D 4000 S



16	DISCHARGE AUGER SHAFT	41984300	1	1000898	4014486473414
16	DISCHARGE AUGER SHAFT	41984300	1	1000898	4014486473414
17	MAIN FAN SELECTOR	41926300	1	1000230	4014486463187
17	MAIN FAN SELECTOR	41926300	1	1000230	4014486463187
17	MAIN FAN SELECTOR	41926300	1	1000230	4014486463187
18	MAIN FAN	41930300	1	1003426	4014486464092
18	MAIN FAN	41930300	1	1003426	4014486464092
18	MAIN FAN	41930300	1	1003426	4014486464092
19	ECCENTRIC SHAFT DRIVE	41966500	1	1003444	4014486465235
19	ECCENTRIC SHAFT DRIVE	41934900	1	1003445	4014486465303
19	ECCENTRIC SHAFT DRIVE	41934900	1	1003445	4014486465303
19	ECCENTRIC SHAFT DRIVE	41934900	1	1003445	4014486465303
20	THRESHING DRUM VARIATOR DRIVE	41980300	1	1001439	4014486459470
20	THRESHING DRUM VARIATOR DRIVE	41980300	1	1001439	4014486459470
1	STRIPPER BEATER	41964300	1	1003405	4014486463309
2	FILLING AUGER	41972200	1	1001353	4014486474664
2	FILLING AUGER	41972300	1	1001353	4014486474664
3	STRIPPER BEATER	41992200	1	1001653	4014486486063
3	STRIPPER BEATER	41992200	1	1001653	4014486486063
3	STRIPPER BEATER	41992200	1	1001653	4014486486063
4	HYDRAULIC PUMP DRIVE	41924900	1	1003394	4014486462692

DRONNINGBORG D 4000 S



No.	Application	OEM - PN	Set	Optibelt AP-Nr.	EAN
4	HYDRAULIC PUMP DRIVE	41924900	1	1003394	4014486462692
4	HYDRAULIC PUMP DRIVE	41924900	1	1003394	4014486462692
5	PROPULSION PUMP DRIVE	41992100	1	1001643	4014486485950
5	PROPULSION PUMP DRIVE	41992100	1	1001643	4014486485950
5	PROPULSION PUMP DRIVE	41992100	1	1001643	4014486485950
6	STRAW CHOPPER DRIVE	41958500	1	1000859	4014486472936
6	STRAW CHOPPER DRIVE	41958500	1	1000859	4014486472936
6	STRAW CHOPPER DRIVE	41958500	1	1000859	4014486472936
7	FEEDER DRUM	41953700	1	1003505	4014486469196
8	COUNTERSHAFT DRIVE	41964400	1	1003409	4014486463415
9	COUNTERSHAFT DRIVE	41992700	1	1000910	4014486473575
9	COUNTERSHAFT DRIVE	41992700	1	1000910	4014486473575
9	COUNTERSHAFT DRIVE	41992400	1	1000918	4014486473674
10	FEEDER SHAFT (UPPER)	41983900	1	1003521	4014486469882
10	FEEDER SHAFT (UPPER)	41983900	1	1003521	4014486469882
10	FEEDER SHAFT (UPPER)	41983900	1	1003521	4014486469882
11	COUNTER DRIVE STRAW CHOPPER	41955900	1	1000704	4014486470888
11	COUNTER DRIVE STRAW CHOPPER	41955900	1	1000704	4014486470888
11	COUNTER DRIVE STRAW CHOPPER	41955900	1	1000704	4014486470888
12	STRAW WALKER - ECCENTRIC	41972800	1	1001355	4014486474695
12	STRAW WALKER - ECCENTRIC	41972800	1	1001355	4014486474695
12	STRAW WALKER - ECCENTRIC	41972800	1	1001355	4014486474695

DRONNINGBORG D 4000 S



13	AWNER SHAFT - FAN SHAFT	41958500	1	1000859	4014486472936
13	AWNER SHAFT - FAN SHAFT	41978500	1	1001365	4014486474794
13	AWNER SHAFT - FAN SHAFT	41978500	1	1001365	4014486474794
14	INTERMEDIATE SHAFT	41926600	1	1000235	4014486463361
14	INTERMEDIATE SHAFT	41926600	1	1000235	4014486463361
14	INTERMEDIATE SHAFT	41926600	1	1000235	4014486463361
15	ELEVATOR DRIVE GRAIN	41937600	1	1003450	4014486465600
15	ELEVATOR DRIVE GRAIN	41937600	1	1003450	4014486465600
15	ELEVATOR DRIVE GRAIN	41937600	1	1003450	4014486465600
16	DISCHARGE AUGER SHAFT	41984300	1	1000898	4014486473414
16	DISCHARGE AUGER SHAFT	41984300	1	1000898	4014486473414
16	DISCHARGE AUGER SHAFT	41984300	1	1000898	4014486473414
17	MAIN FAN SELECTOR	41926300	1	1000230	4014486463187
17	MAIN FAN SELECTOR	41926300	1	1000230	4014486463187
17	MAIN FAN SELECTOR	41926300	1	1000230	4014486463187
18	MAIN FAN	41930300	1	1003426	4014486464092
18	MAIN FAN	41930300	1	1003426	4014486464092
18	MAIN FAN	41930300	1	1003426	4014486464092
19	ECCENTRIC SHAFT DRIVE	41966500	1	1003444	4014486465235
19	ECCENTRIC SHAFT DRIVE	41934900	1	1003445	4014486465303
19	ECCENTRIC SHAFT DRIVE	41934900	1	1003445	4014486465303
19	ECCENTRIC SHAFT DRIVE	41934900	1	1003445	4014486465303

DRONNINGBORG D 4000 S, D 4500



No.	Application	OEM - PN	Set	Optibelt AP-Nr.	EAN
20	THRESHING DRUM VARIATOR DRIVE	41980300	1	1001439	4014486459470
20	THRESHING DRUM VARIATOR DRIVE	41980300	1	1001439	4014486459470
1	RETURN AUGER (UPPER)	41964300	1	1003405	4014486463309
2	FILLING AUGER	41972100	1	1001352	4014486474657
3	STRIPPER BEATER	41991600	1	1003647	4014486489279
4	HYDRAULIC PUMP DRIVE	41991400	1	1001559	4014486484588
5	STRAW CHOPPER DRIVE	41958500	1	1000859	4014486472936
7	COUNTERSHAFT DRIVE	41989100	1	1000915	4014486473643
8	FEEDER SHAFT (UPPER)	41988900	1	1000899	4014486473438
9	COUNTER DRIVE STRAW CHOPPER	41955900	1	1000704	4014486470888
10	STRAW SHAKER - ECCENTRIC SHAFT	41972800	1	1001355	4014486474695
13	FAN SHAFT AWNER SHAFT	41978500	1	1001365	4014486474794
14	INTERMEDIATE SHAFT	41912300	1	1003380	4014486461749
16	ELEVATOR DRIVE GRAIN	41935700	1	1003447	4014486465464
17	DISCHARGE AUGER SHAFT	41988700	1	1003562	4014486473452
18	MAIN FAN SELECTOR	41926300	1	1000230	4014486463187
19	MAIN FAN	41930300	1	1003426	4014486464092
20	ECCENTRIC SHAFT DRIVE	41935500	1	1000321	4014486465419
21	THRESHING DRUM VARIATOR DRIVE	41980800	1	1001501	4014486460155

DRONNINGBORG D 500, D 600



BISO - Schrattecker
 BIZON
 CASE INTL. HARVESTER
 CLAAS
 DEUTZ-FAHR
 DRONNINGBORG
 FENDT
 FORTSCHRITT
 JOHN DEERE
 KRONE
 LAVERDA
 MASSEY FERGUSON
 NEW HOLLAND
 ROSTSELMASH

No.	Application	OEM - PN	Set	Optibelt AP-Nr.	EAN
2	STRIPPER BEATER - SHAKER	41974300	1	1001357	4014486474718
4	RETURN ELEVATOR DRIVE	41932800	1	1003437	4014486464818
6	FAN SECOND CLEANER	41974300	1	1001357	4014486474718
9	FILLING AUGER	41964500	1	1003408	4014486463392
14	HYDRAULIC PUMP DRIVE	41902600	1	1000086	4014486460834
2	STRIPPER BEATER - SHAKER	41974300	1	1001357	4014486474718
4	RETURN ELEVATOR DRIVE	41932800	1	1003437	4014486464818
6	FAN SECOND CLEANER	41974300	1	1001357	4014486474718
9	FILLING AUGER	41964500	1	1003408	4014486463392
14	HYDRAULIC PUMP DRIVE	41902600	1	1000086	4014486460834

DRONNINGBORG D 7000

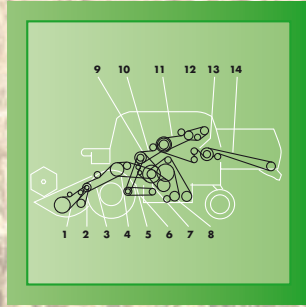
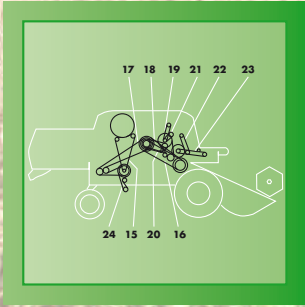

No.	Application	OEM - PN	Set	Optibelt AP-Nr.	EAN
1	FEEDER DRUM	41983500	1	1000611	4014486469493
2	CRANKSHAFT	41964300	1	1003405	4014486463309
3	COUNTERSHAFT DRIVE	41993000	1	1001104	4014486496864
5		41950600	1	1003524	4014486469998
6		41950900	1	1000600	4014486469325
7	ECCENTRIC SHAFT DRIVE	41982400	1	1003501	4014486469059
8	STRAW SHAKER CRANK - GRAIN AUGER	41990100	1	1001377	4014486474916
9	INTERMEDIATE SHAFT	41987200	1	1003518	4014486469714
10	STRIPPER BEATER	41935200	1	1000318	4014486465372
11	COUNTERSHAFT DRIVE	41993400	1	1003633	4014486488609
12	HYDRAULIC PUMP DRIVE	41928900	1	1000249	4014486463828
12	HYDRAULIC PUMP DRIVE	41929000	1	1000251	4014486463897

DRONNINGBORG D 7000

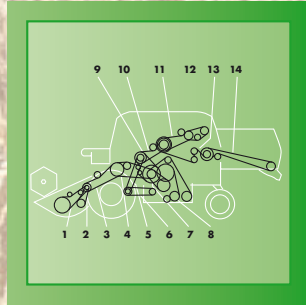
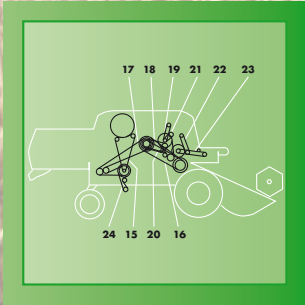

12	HYDRAULIC PUMP DRIVE	41930200	1	1000260	4014486464108
12	HYDRAULIC PUMP DRIVE	41929200	1	1003424	4014486463996
13	COUNTER DRIVE STRAW CHOPPER	41942100	1	1000404	4014486466676
14	STRAW CHOPPER DRIVE	41987300	1	1000815	4014486472400
15	AWNER SHAFT	41912400	1	1003381	4014486461732
16	THRESHING DRUM VARIATOR DRIVE	41999200	1	1004068	4014486518375
18	DISCHARGE AUGER SHAFT	41935900	1	1000328	4014486465587
18	DISCHARGE AUGER SHAFT	41936200	2	1002770	4014486465648
20	STRIPPER BEATER	41982400	1	1003501	4014486469059
25	MAIN FAN SELECTOR - MAIN FAN	41982200	1	1003499	4014486469004
26	COUNTER DRIVE RADIATOR	41905300	1	1000114	4014486461220
27	COUNTER DRIVE RADIATOR	41911000	1	1000143	4014486461619

DRONNINGBORG D 7000 S

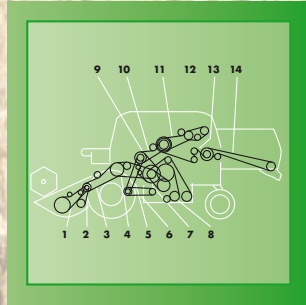
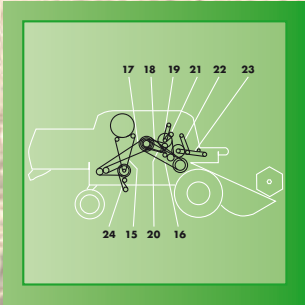

No.	Application	OEM - PN	Set	Optibelt AP-Nr.	EAN
1	FEEDER DRUM	41983500	1	1000611	4014486469493
2	CRANKSHAFT	41964300	1	1003405	4014486463309
3	COUNTERSHAFT DRIVE	41993000	1	1001104	4014486496864
5		41950600	1	1003524	4014486469998
6		41950900	1	1000600	4014486469325
7	ECCENTRIC SHAFT DRIVE	41982400	1	1003501	4014486469059
8	STRAW SHAKER CRANK - GRAIN AUGER	41990100	1	1001377	4014486474916
9	INTERMEDIATE SHAFT	41987200	1	1003518	4014486469714
10	STRIPPER BEATER	41935200	1	1000318	4014486465372
11	COUNTERSHAFT DRIVE	41993400	1	1003633	4014486488609
12	HYDRAULIC PUMP DRIVE	41928900	1	1000249	4014486463828
12	HYDRAULIC PUMP DRIVE	41929000	1	1000251	4014486463897

DRONNINGBORG D 7000 S

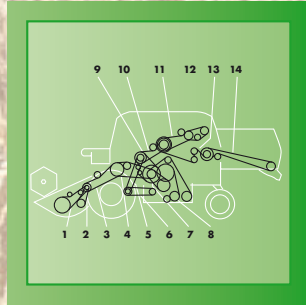
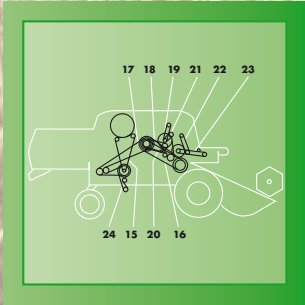

12	HYDRAULIC PUMP DRIVE	41930200	1	1000260	4014486464108
12	HYDRAULIC PUMP DRIVE	41929200	1	1003424	4014486463996
13	COUNTER DRIVE STRAW CHOPPER	41942100	1	1000404	4014486466676
14	STRAW CHOPPER DRIVE	41987300	1	1000815	4014486472400
15	AWNER SHAFT	41912400	1	1003381	4014486461732
16	THRESHING DRUM VARIATOR DRIVE	41999200	1	1004068	4014486518375
18	DISCHARGE AUGER SHAFT	41935900	1	1000328	4014486465587
18	DISCHARGE AUGER SHAFT	41936200	2	1002770	4014486465648
20	STRIPPER BEATER	41982400	1	1003501	4014486469059
25	MAIN FAN SELECTOR - MAIN FAN	41982200	1	1003499	4014486469004
26	COUNTER DRIVE RADIATOR	41905300	1	1000114	4014486461220
27	COUNTER DRIVE RADIATOR	41911000	1	1000143	4014486461619

DRONNINGBORG D 7200

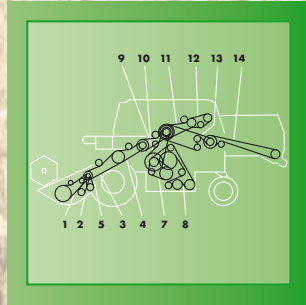
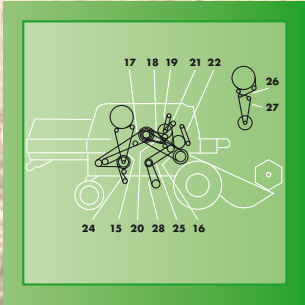

No.	Application	OEM - PN	Set	Optibelt AP-Nr.	EAN
1	FEEDER DRUM	41983500	1	1000611	4014486469493
1	FEEDER DRUM	41983500	1	1000611	4014486469493
1	FEEDER DRUM	41983600	1	1000611	4014486469493
2	CRANKSHAFT	41963900	1	1000233	4014486463293
2	CRANKSHAFT	41964300	1	1003405	4014486463309
3	COUNTERSHAFT DRIVE	41989200	1	1000908	4014486473568
3	COUNTERSHAFT DRIVE	41989400	1	1000911	4014486473605
4	FEEDER SHAFT (UPPER)	41991700	1	1001844	4014486488739
7	ECCENTRIC SHAFT DRIVE	41982500	1	1000585	4014486469066
7	ECCENTRIC SHAFT DRIVE	41982400	1	1003501	4014486469059
8	STRAW SHAKER CRANK - GRAIN AUGER	41990100	1	1001377	4014486474916
8	STRAW SHAKER CRANK	41990400	1	1003581	4014486474930
9	INTERMEDIATE SHAFT	41988000	1	1000698	4014486470802
10	STRIPPER BEATER	41934800	3	1002768	4014486465228
11	COUNTER SELECTOR	41993400	1	1003633	4014486488609
12	HYDRAULIC PUMP DRIVE	41929000	1	1000251	4014486463897

DRONNINGBORG D 7200

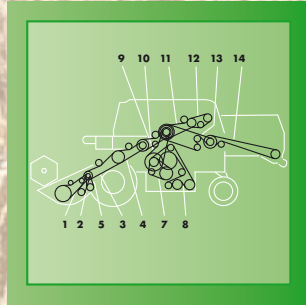
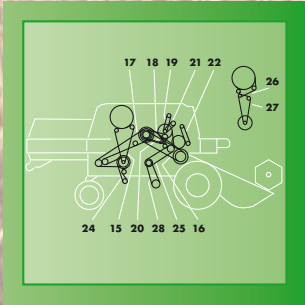

12	HYDRAULIC PUMP DRIVE	41930200	1	1000260	4014486464108
13	COUNTER DRIVE STRAW CHOPPER	41942100	1	1000404	4014486466676
14	STRAW CHOPPER DRIVE	41987300	1	1000815	4014486472400
15	AWNER SHAFT	41912300	1	1003380	4014486461749
15	AWNER SHAFT	41912400	1	1003381	4014486461732
17	FAN SHAFT AWNER SHAFT	41990400	1	1003581	4014486474930
18	DISCHARGE AUGER SHAFT	41936200	2	1002770	4014486465648
20	STRIPPER BEATER	41982500	1	1000585	4014486469066
25	MAIN FAN SELECTOR	41987900	1	1000575	4014486468847
26	COUNTER DRIVE RADIATOR	41905300	1	1000114	4014486461220
27	COUNTER DRIVE RADIATOR	41911000	1	1000143	4014486461619
28	MAIN FAN	41987900	1	1000575	4014486468847
28	MAIN FAN	41982100	1	1000582	4014486469011
28	MAIN FAN	41982200	1	1003499	4014486469004

DRONNINGBORG D 7500

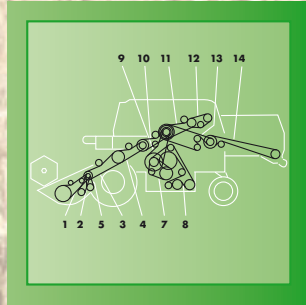
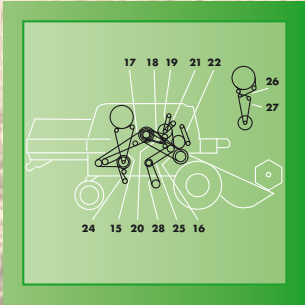

No.	Application	OEM - PN	Set	Optibelt AP-Nr.	EAN
1	FEEDER DRUM	41983500	1	1000611	4014486469493
1	FEEDER DRUM	41983500	1	1000611	4014486469493
1	FEEDER DRUM	41983600	1	1000611	4014486469493
2	CRANKSHAFT	41963900	1	1000233	4014486463293
2	CRANKSHAFT	41964300	1	1003405	4014486463309
3	COUNTERSHAFT DRIVE	41989200	1	1000908	4014486473568
3	COUNTERSHAFT DRIVE	41989400	1	1000911	4014486473605
4	FEEDER SHAFT (UPPER)	41991700	1	1001844	4014486488739
7	ECCENTRIC SHAFT DRIVE	41982500	1	1000585	4014486469066
7	ECCENTRIC SHAFT DRIVE	41982400	1	1003501	4014486469059
8	STRAW SHAKER CRANK - GRAIN AUGER	41990100	1	1001377	4014486474916
8	STRAW SHAKER CRANK - GRAIN AUGER	41990400	1	1003581	4014486474930
9	INTERMEDIATE SHAFT	41988000	1	1000698	4014486470802
10	STRIPPER BEATER	41934800	3	1002768	4014486465228
11	COUNTERSHAFT DRIVE	41993400	1	1003633	4014486488609
12	ENGINE - HYDRAULIC PUMP	41929000	1	1000251	4014486463897

DRONNINGBORG D 7500

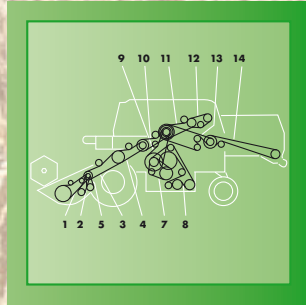
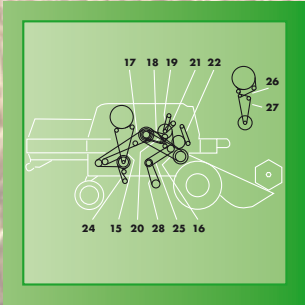

12	HYDRAULIC PUMP DRIVE	41930200	1	1000260	4014486464108
13	COUNTER DRIVE STRAW CHOPPER	41942100	1	1000404	4014486466676
14	STRAW CHOPPER DRIVE	41987300	1	1000815	4014486472400
15	AWNER SHAFT	41912300	1	1003380	4014486461749
15	AWNER SHAFT	41912400	1	1003381	4014486461732
16	THRESHING DRUM VARIATOR DRIVE	41980900	1	1001526	4014486460452
17	FAN SHAFT AWNER SHAFT	41990400	1	1003581	4014486474930
18	DISCHARGE AUGER SHAFT	41936200	2	1002770	4014486465648
20	STRIPPER BEATER	41982500	1	1000585	4014486469066
25	MAIN FAN SELECTOR	41987900	1	1000575	4014486468847
26	COUNTER DRIVE RADIATOR	41905300	1	1000114	4014486461220
27	COUNTER DRIVE RADIATOR	41911000	1	1000143	4014486461619
28	MAIN FAN	41987900	1	1000575	4014486468847
28	MAIN FAN SELECTOR - MAIN FAN	41982100	1	1000582	4014486469011
28	MAIN FAN	41982200	1	1003499	4014486469004

DRONNINGBORG D 8000

No.	Application	OEM - PN	Set	Optibelt AP-Nr.	EAN
1	FEEDER DRUM	41983500	1	1000611	4014486469493
1	FEEDER DRUM	41983500	1	1000611	4014486469493
1	FEEDER DRUM	41983600	1	1000611	4014486469493
2	CRANKSHAFT	41964300	1	1003405	4014486463309
2	CRANKSHAFT	41964300	1	1003405	4014486463309
3	COUNTERSHAFT DRIVE	41993000	1	1001104	4014486496864
5		41950600	1	1003524	4014486469998
6		41950900	1	1000600	4014486469325
7	ECCENTRIC SHAFT DRIVE	41982400	1	1003501	4014486469059
8	STRAW SHAKER CRANK - GRAIN AUGER	41990100	1	1001377	4014486474916
9	INTERMEDIATE SHAFT	41987200	1	1003518	4014486469714
10	STRIPPER BEATER	41935200	1	1000318	4014486465372
11	COUNTER SELECTOR	41993400	1	1003633	4014486488609
12	HYDRAULIC PUMP DRIVE	41929000	1	1000251	4014486463897
12	HYDRAULIC PUMP DRIVE	41930200	1	1000260	4014486464108
12	HYDRAULIC PUMP DRIVE	41930300	1	1003426	4014486464092
13	COUNTER DRIVE STRAW CHOPPER	41942100	1	1000404	4014486466676
14	STRAW CHOPPER DRIVE	41987600	1	1000853	4014486472844
15	AWNER SHAFT	41912400	1	1003381	4014486461732
16	THRESHING DRUM VARIATOR DRIVE	41999200	1	1004068	4014486518375
18	DISCHARGE AUGER SHAFT	41935900	1	1000328	4014486465587
18	DISCHARGE AUGER SHAFT	41936200	2	1002770	4014486465648

DRONNINGBORG D 8000, D 8000 S



20	STRIPPER BEATER	41982400	1	1003501	4014486469059
25	MAIN FAN SELECTOR	41982200	1	1003499	4014486469004
26	COUNTER DRIVE RADIATOR	41905300	1	1000114	4014486461220
27	COUNTER DRIVE RADIATOR	41911000	1	1000143	4014486461619
1	FEEDER DRUM	41983500	1	1000611	4014486469493
1	FEEDER DRUM	41983500	1	1000611	4014486469493
1	FEEDER DRUM	41983600	1	1000611	4014486469493
2	CRANKSHAFT	41964300	1	1003405	4014486463309
2	CRANKSHAFT	41964300	1	1003405	4014486463309
3	COUNTERSHAFT DRIVE	41993000	1	1001104	4014486496864
5		41950600	1	1003524	4014486469998
6		41950900	1	1000600	4014486469325
7	ECCENTRIC SHAFT DRIVE	41982400	1	1003501	4014486469059
8	STRAW SHAKER CRANK - GRAIN AUGER	41990100	1	1001377	4014486474916
9	INTERMEDIATE SHAFT	41987200	1	1003518	4014486469714
10	STRIPPER BEATER	41935200	1	1000318	4014486465372
11	COUNTER SELECTOR	41993400	1	1003633	4014486488609
12	HYDRAULIC PUMP DRIVE	41929000	1	1000251	4014486463897
12	HYDRAULIC PUMP DRIVE	41930200	1	1000260	4014486464108
12	HYDRAULIC PUMP DRIVE	41930300	1	1003426	4014486464092
13	COUNTER DRIVE STRAW CHOPPER	41942100	1	1000404	4014486466676

DRONNINGBORG D 8000 S



No.	Application	OEM - PN	Set	Optibelt AP-Nr.	EAN
14	STRAW CHOPPER DRIVE	41987600	1	1000853	4014486472844
15	AWNER SHAFT	41912400	1	1003381	4014486461732
16	THRESHING DRUM VARIATOR DRIVE	41999200	1	1004068	4014486518375
18	DISCHARGE AUGER SHAFT	41935900	1	1000328	4014486465587
18	DISCHARGE AUGER SHAFT	41936200	2	1002770	4014486465648
20	STRIPPER BEATER	41982400	1	1003501	4014486469059
25	MAIN FAN SELECTOR	41982200	1	1003499	4014486469004
26	COUNTER DRIVE RADIATOR	41905300	1	1000114	4014486461220
27	COUNTER DRIVE RADIATOR	41911000	1	1000143	4014486461619

DRONNINGBORG D 8400

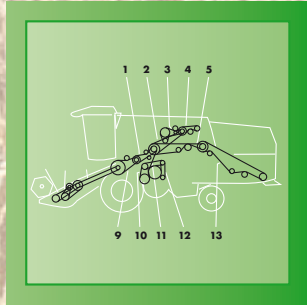
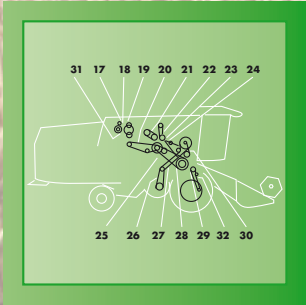

No.	Application	OEM - PN	Set	Optibelt AP-Nr.	EAN
1	STRIPPER BEATER	41934800	3	1002768	4014486465228
2	COUNTERSHAFT DRIVE	41990051	1	1001877	4014486489255
3	DISCHARGE AUGER SHAFT	41990050	1	1003600	4014486485196
5	INTERMEDIATE SHAFT - STRAW CHOPPER	41942200	1	1000410	4014486466737
6	KNIFE DRIVE	41985600	1	1000693	4014486470741
9	FEEDER SHAFT (UPPER)	41991700	1	1001844	4014486488739
10	ECCENTRIC SHAFT DRIVE	41982100	1	1000582	4014486469011
11	INTERMEDIATE SHAFT	41984100	1	1000655	4014486470185
12	STRAW SHAKER CRANK	41990068	1	1001368	4014486474824
13	STRAW CHOPPER DRIVE	41978400	1	1001725	4014486487084
17	AIR CONDITIONING COMPRESSOR DRIVE	41991000	1	1002346	4014486478792
17	AIR CONDITIONING COMPRESSOR DRIVE	41909000	1	1003748	4014486496048
19	SUCTION STRAINER	41990009	1	1002357	4014486478907
20	DUST EXTRACTOR	41936700	1	1000327	4014486465556
21	DISCHARGE AUGER SHAFT	41979600	1	1003347	4014486486285
23	INTERMEDIATE SHAFT - FILL ELEVATOR	41950100	1	1000627	4014486469776
25	COUNTERSHAFT - GRAIN SEPARATOR	41982100	1	1000582	4014486469011
26	MAIN FAN	41982100	1	1000582	4014486469011
27	MAIN FAN VARIABLE SPEED DRIVE	41987900	1	1000575	4014486468847
28	THRESHING DRUM VARIATOR DRIVE	41980900	1	1001526	4014486460452
29	DISCHARGE AUGER SHAFT	41950400	1	1003517	4014486469691

DRONNINGBORG D 8500

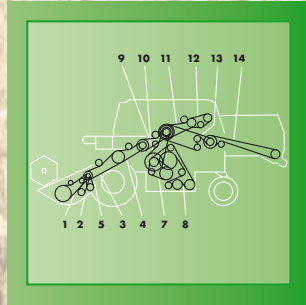
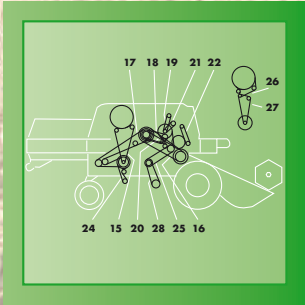

No.	Application	OEM - PN	Set	Optibelt AP-Nr.	EAN
1	FEEDER DRUM	41983500	1	1000611	4014486469493
1	FEEDER DRUM	41983600	1	1000611	4014486469493
2	CRANKSHAFT	41963900	1	1000233	4014486463293
2	CRANKSHAFT	41964300	1	1003405	4014486463309
3	COUNTERSHAFT DRIVE	41989200	1	1000908	4014486473568
3	COUNTERSHAFT DRIVE	41989400	1	1000911	4014486473605
4	FEEDER SHAFT (UPPER)	41991700	1	1001844	4014486488739
7	ECCENTRIC SHAFT DRIVE	41982500	1	1000585	4014486469066
7	ECCENTRIC SHAFT DRIVE	41982400	1	1003501	4014486469059
8	STRAW SHAKER CRANK - GRAIN AUGER	41990100	1	1001377	4014486474916
8	STRAW SHAKER CRANK	41990069	1	1001378	4014486474923
8	STRAW SHAKER CRANK	41990400	1	1003581	4014486474930
9	INTERMEDIATE SHAFT	41988000	1	1000698	4014486470802
10	STRIPPER BEATER	41934800	3	1002768	4014486465228
11	COUNTER SELECTOR	41991300	1	1001836	4014486488616
11	COUNTER SELECTOR	41993400	1	1003633	4014486488609

DRONNINGBORG D 8500

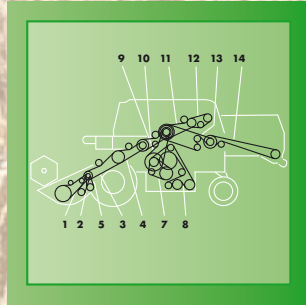
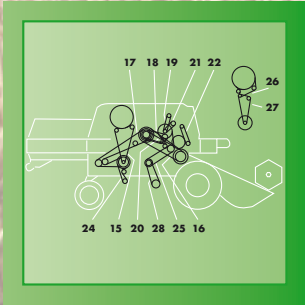

12	HYDRAULIC PUMP DRIVE	41930200	1	1000260	4014486464108
13	COUNTER DRIVE STRAW CHOPPER	41942100	1	1000404	4014486466676
14	STRAW CHOPPER DRIVE	41987300	1	1000815	4014486472400
15	AWNER SHAFT	41912300	1	1003380	4014486461749
15	AWNER SHAFT	41912400	1	1003381	4014486461732
17	FAN SHAFT AWNER SHAFT	41990069	1	1001378	4014486474923
18	DISCHARGE AUGER SHAFT	41936200	2	1002770	4014486465648
20	STRIPPER BEATER	41982400	1	1003501	4014486469059
25	MAIN FAN SELECTOR	41987900	1	1000575	4014486468847
26	COUNTER DRIVE RADIATOR	41905300	1	1000114	4014486461220
27	COUNTER DRIVE RADIATOR	41911000	1	1000143	4014486461619
28	MAIN FAN SELECTOR - MAIN FAN	41987900	1	1000575	4014486468847
28	MAIN FAN SELECTOR - MAIN FAN	41982100	1	1000582	4014486469011
28	MAIN FAN SELECTOR - MAIN FAN	41982200	1	1003499	4014486469004

DRONNINGBORG D 8700

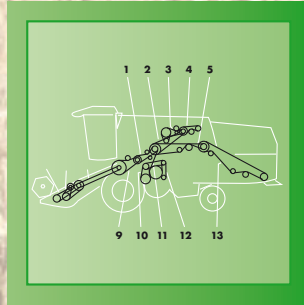
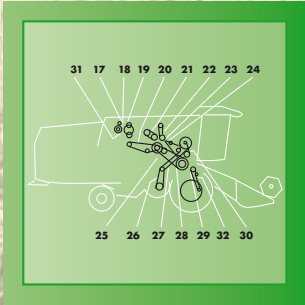

No.	Application	OEM - PN	Set	Optibelt AP-Nr.	EAN
1	STRIPPER BEATER	41934800	3	1002768	4014486465228
2	COUNTERSHAFT DRIVE	41990051	1	1001877	4014486489255
3	DISCHARGE AUGER SHAFT	41990050	1	1003600	4014486485196
5	INTERMEDIATE SHAFT - STRAW CHOPPER	41942200	1	1000410	4014486466737
6	KNIFE DRIVE	41985600	1	1000693	4014486470741
9	FEEDER SHAFT (UPPER)	41991700	1	1001844	4014486488739
10	ECCENTRIC SHAFT DRIVE	41982100	1	1000582	4014486469011
11	INTERMEDIATE SHAFT	41984100	1	1000655	4014486470185
12	STRAW SHAKER CRANK	41990068	1	1001368	4014486474824
13	STRAW CHOPPER DRIVE	41978400	1	1001725	4014486487084
17	AIR CONDITIONING COMPRESSOR DRIVE	41991000	1	1002346	4014486478792
17	AIR CONDITIONING COMPRESSOR DRIVE	41909000	1	1003748	4014486496048
19	SUCTION STRAINER	41990009	1	1002357	4014486478907
20	DUST EXTRACTOR	41936700	1	1000327	4014486465556
21	DISCHARGE AUGER SHAFT	41979600	1	1003347	4014486486285
23	INTERMEDIATE SHAFT - FILL ELEVATOR	41950100	1	1000627	4014486469776
25	COUNTERSHAFT - GRAIN SEPARATOR	41982100	1	1000582	4014486469011
26	MAIN FAN	41982100	1	1000582	4014486469011
27	MAIN FAN VARIABLE SPEED DRIVE	41987900	1	1000575	4014486468847
28	THRESHING DRUM VARIATOR DRIVE	41980900	1	1001526	4014486460452
29	DISCHARGE AUGER SHAFT	41950400	1	1003517	4014486469691

DRONNINGBORG D 8900



BISO - Schrattecker
 BIZON
 CASE INTL. HARVESTER
 CLAAS
 DEUTZ-FAHR
 DRONNINGBORG
 FENDT
 FORTSCHRITT
 JOHN DEERE
 KRONE
 LAVERDA
 MASSEY FERGUSON
 NEW HOLLAND
 ROSTSELMASH

No.	Application	OEM - PN	Set	Optibelt AP-Nr.	EAN
1		41933700	2	1002760	4014486464993
2		41979400	1	1001251	4014486492071
3		41979100	1	1001607	4014486485332
5		41979600	1	1003347	4014486486285
6		41978900	1	1001730	4014486487145
7		41983500	1	1000611	4014486469493
7		41983600	1	1000611	4014486469493
8		41963900	1	1000233	4014486463293
11		41979800	1	1001990	4014486491104
12		41990001	1	1002212	4014486477634
13		41933700	2	1002760	4014486464993
14		41979000	1	1001632	4014486485776
17		41911000	1	1000143	4014486461619
19		41986100	1	1000675	4014486470475
20		41998800	1	1000278	4014486464528
22		41937500	2	1002773	4014486465891
23		41978800	1	1001683	4014486486544
27		41981200	1	1001427	4014486459357
28		41981100	1	1001436	4014486459449
29		41981000	1	1001539	4014486460582
30		41985200	1	1000603	4014486469370
31		41985300	1	1003514	4014486469622

DRONNINGBORG D 900



No.	Application	OEM - PN	Set	Optibelt AP-Nr.	EAN
2	COUNTERSHAFT (PRIMARY)	41996400	1	1002071	4014486475579
3	HYDRAULIC PUMP DRIVE	41922200	1	1000186	4014486462159
4	GEAR BOX	41994300	1	1001215	4014486497748
5	REEL DRIVE - VARIATOR PULLEY	41962000	1	1000192	4014486462234
6	REEL DRIVE	41939300	1	1000366	4014486466287
7		41926100	1	1000224	4014486462913
8	COUNTERSHAFT DRIVE	41903000	1	1000089	4014486460865
9	FEEDER AUGER	41982400	1	1003501	4014486469059
10	MAIN BLOWER SHAKER BEATER	41974300	1	1001357	4014486474718
11	FILLING AUGER	41938900	1	1000356	4014486466133
12	THRESHING DRUM/FAN	41974300	1	1001357	4014486474718
14	BEATER RETURN ELEVATOR	41932800	1	1003437	4014486464818
15		41904900	1	1000112	4014486461183
17	COUNTERSHAFT DRIVE	41954800	1	1003537	4014486470611
18	COUNTERSHAFT DRIVE	41995700	1	1001429	4014486459371
19	DRIVING GEAR FOR AUGER	41955800	1	1000757	4014486471588
20		41962600	1	1000201	4014486462395

DRONNINGBORG D 9000

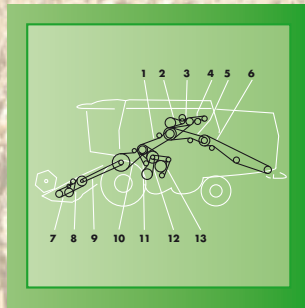
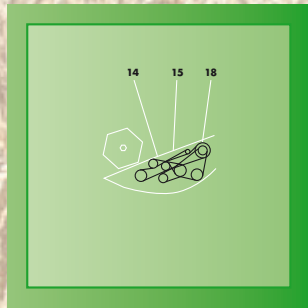
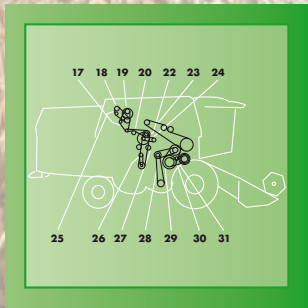

No.	Application	OEM - PN	Set	Optibelt AP-Nr.	EAN
1	COUNTERSHAFT DRIVE	41979900	1	1003576	4014486492217
2	DISCHARGE AUGER SHAFT	41979400	1	1001251	4014486492071
3	DIESEL ENGINE	41979100	1	1001607	4014486485332
5	INTERMEDIATE SHAFT - STRAW CHOPPER	41979600	1	1003347	4014486486285
6	STRAW CHOPPER DRIVE	41978900	1	1001730	4014486487145
7	KNIFE DRIVE	41985600	1	1000693	4014486470741
10	FEEDER SHAFT (UPPER)	41979800	1	1001990	4014486491104
11	STRIPPER BEATER	41990001	1	1002212	4014486477634
12	ECCENTRIC SHAFT - INTERMEDIATE SHAFT	41933700	2	1002760	4014486464993
13	STRAW SHAKER CRANK	41979000	1	1001632	4014486485776
14	KNIFE DRIVE	41986300	1	1000756	4014486471571
17	DIESEL ENGINE	41911000	1	1000143	4014486461619
19	INTERMEDIATE SHAFT - FILL ELEVATOR	41986100	1	1000675	4014486470475
20	DUST EXTRACTOR - COUNTERSHAFT	41998800	1	1000278	4014486464528
22	COUNTERSHAFT DRIVE	41937500	2	1002773	4014486465891
23	DISCHARGE AUGER SHAFT	41978800	1	1001683	4014486486544
25	AIR CONDITIONING COMPRESSOR DRIVE	41909000	1	1003748	4014486496048
27	MAIN FAN RADIATOR	41981200	1	1001427	4014486459357
28	MAIN FAN	41981100	1	1001436	4014486459449
29	INTERMEDIATE SHAFT - VARIATOR DRIVE	41981000	1	1001539	4014486460582
30	INTERMEDIATE SHAFT - VARIATOR DRIVE	41985200	1	1000603	4014486469370
31	THRESHING DRUM VARIATOR DRIVE	41985300	1	1003514	4014486469622

DRONNINGBORG D 950

No.	Application	OEM - PN	Set	Optibelt AP-Nr.	EAN
2	COUNTERSHAFT (PRIMARY)	41996400	1	1002071	4014486475579
3	HYDRAULIC PUMP DRIVE	41922200	1	1000186	4014486462159
4	GEAR BOX	41994300	1	1001215	4014486497748
5	REEL DRIVE - VARIATOR PULLEY	41962000	1	1000192	4014486462234
6	REEL DRIVE	41939300	1	1000366	4014486466287
7		41926100	1	1000224	4014486462913
8	COUNTERSHAFT DRIVE	41903000	1	1000089	4014486460865
9	FEEDER AUGER	41982400	1	1003501	4014486469059
10	MAIN BLOWER SHAKER BEATER	41974300	1	1001357	4014486474718
11	FILLING AUGER	41938900	1	1000356	4014486466133
12	THRESHING DRUM/FAN	41974300	1	1001357	4014486474718
14	BEATER RETURN ELEVATOR	41932800	1	1003437	4014486464818
15		41904900	1	1000112	4014486461183
17	COUNTERSHAFT DRIVE	41954800	1	1003537	4014486470611
18	COUNTERSHAFT DRIVE	41995700	1	1001429	4014486459371
19	DRIVING GEAR FOR AUGER	41955800	1	1000757	4014486471588
20		41962600	1	1000201	4014486462395

FENDT 5250



BISO - Schrattecker
 BIZON
 CASE INTL. HARVESTER
 CLAAS
 DEUTZ-FAHR
 DRONNING-BORG
 FENDT
 FORTSCHRITT
 JOHN DEERE
 KRONE
 LAVERDA
 MASSEY FERGUSON
 NEW HOLLAND
 ROSTSELMASH

No.	Application	OEM - PN	Set	Optibelt AP-Nr.	EAN
1		340433422	1	1000606	4014486520514
2		340433253	1	1000231	4014486520491
3		340433197	1	1000164	4014486461879
4		344311227	1	1001820	4014486488371
5		344312128	1	1003623	4014486487503
6		340433984	1	1001346	4014486474596
7		340435152	1	1001539	4014486460582
8		344311318	1	1002000	4014486491265
9		340433539	1	1001120	4014486497069
10		340433474	1	1000789	4014486472059
11		344311131	1	1001640	4014486485929
12		344311151	1	1001717	4014486486995
13		344311123	1	1001622	4014486485554
14		340435150	1	1001422	4014486459296
15		344311117	1	1003592	4014486484939
16		340433154	1	1003374	4014486461343
17		340433253	1	1000231	4014486520491
18		340434138	1	1001061	4014486496451
19		340433423	1	1000613	4014486469509

FENDT 6300, 6330



No.	Application	OEM - PN	Set	Optibelt AP-Nr.	EAN
1	DRUM DRIVE	41979900	1	1003576	4014486492217
2	THRESHING DRUM VARIATOR DRIVE	41978000	1	1001304	4014486492620
3	DISPOSAL SHAFT DRIVE	41978100	1	1003606	4014486485639
4	THRESHER DRIVE (SECONDARY)	41937800	2	1002774	4014486465815
5	MOVEMENT DRIVE	41990057	1	1003659	4014486490503
6	CRUSHER DRIVE	41979600	1	1003347	4014486486285
1	DRUM DRIVE	41979900	1	1003576	4014486492217
2	THRESHING DRUM VARIATOR DRIVE	41978000	1	1001304	4014486492620
3	DISPOSAL SHAFT DRIVE	41978100	1	1003606	4014486485639
4	THRESHER DRIVE (SECONDARY)	41937800	2	1002774	4014486465815
5	MOVEMENT DRIVE	41990057	1	1003659	4014486490503
6	CRUSHER DRIVE	41979600	1	1003347	4014486486285

FENDT 8300



BISO - Schrottenecker
 BIZON
 CASE INTL. HARVESTER
 CLAAS
 DEUTZ-FAHR
 DRONNING-BORG
 FENDT
 FORTSCHRITT
 JOHN DEERE
 KRONE
 LAVERDA
 MASSEY FERGUSON
 NEW HOLLAND
 ROSTSELMASH

No.	Application	OEM - PN	Set	Optibelt AP-Nr.	EAN
1		28274029	1	1001797	4014486488050
2		41921801	1	1004180	4014486523027
3		41929000	1	1000251	4014486463897
4		41939300	1	1000366	4014486466287
5		41975300	1	1004165	4014486522990
6		41978800	1	1001683	4014486486544
7		41979600	1	1003347	4014486486285
8		41979800	1	1001990	4014486491104
10		41981100	1	1001436	4014486459449
11		41981200	1	1001427	4014486459357
12		41986300	1	1000756	4014486471571
13		41990001	1	1002212	4014486477634
14		41990007	2	1003313	4014486476323
15		41990007	2	1003313	4014486476323
16		41990059	1	1001262	4014486492224
17		41990064	1	1001303	4014486492613
18		685121585	1	1004124	4014486523065

FORTSCHRITT E 514

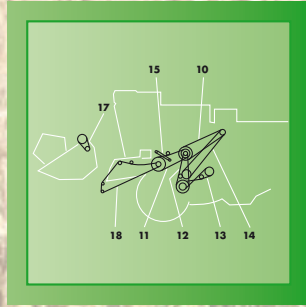
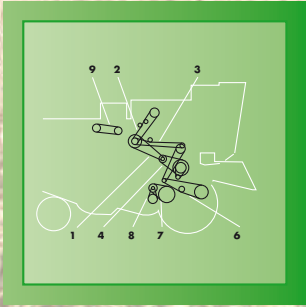

No.	Application	OEM - PN	Set	Optibelt AP-Nr.	EAN
6		4250121772	1	1001617	4014486485479
10		4250121764	1	1003650	4014486489354
16		4250121780	1	1001663	4014486486193

FORTSCHRITT E 516

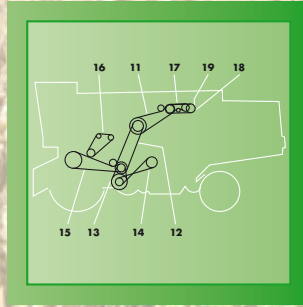
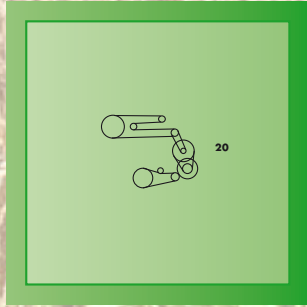
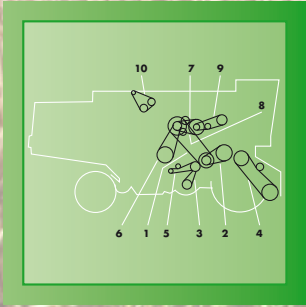

No.	Application	OEM - PN	Set	Optibelt AP-Nr.	EAN
1		4240023362	1	1001207	4014486497663
2		4240023387	1	1001956	4014486490633
3		4240023354	1	1001000	4014486497236
4		4240023395	1	1003652	4014486489491
5		4240044287	1	1002079	4014486475692
6		4240044295	1	1003680	4014486477061
7		4240044301	1	1002148	4014486476637
9		4240044270	2	1003005	4014486476729
10		9911861645	1	1002076	4014486475654
11		4240023370	1	1001990	4014486491104
12		4240044254	2	1002231	4014486477931
13		4240046545	2	1002989	4014486475593
14		4240040388	1	1002185	4014486477290
15		4240023395	1	1003652	4014486489491
16		4240044301	1	1002148	4014486476637
17		4240044262	2	1002131	4014486476361
19		4240043405	2	1003779	4014486476408
20		4240043413	1	1002142	4014486476545

FORTSCHRITT E 516 B



No.	Application	OEM - PN	Set	Optibelt AP-Nr.	EAN
1		4240023362	1	1001207	4014486497663
2		4240023387	1	1001956	4014486490633
3		4240023354	1	1001000	4014486497236
4		4240023395	1	1003652	4014486489491
5		4240044287	1	1002079	4014486475692
6		4240044295	1	1003680	4014486477061
7		4240044301	1	1002148	4014486476637
9		4240044270	2	1003005	4014486476729
10		9911861645	1	1002076	4014486475654
11		4240023370	1	1001990	4014486491104
12		4240044254	2	1002231	4014486477931
13		4240046545	2	1002989	4014486475593
14		4240040388	1	1002185	4014486477290
15		4240023395	1	1003652	4014486489491
16		4240044301	1	1002148	4014486476637
17		4240044262	2	1002131	4014486476361
19		4240043405	2	1003779	4014486476408
20		4240043413	1	1002142	4014486476545

FORTSCHRITT E 517

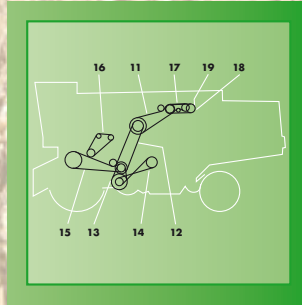
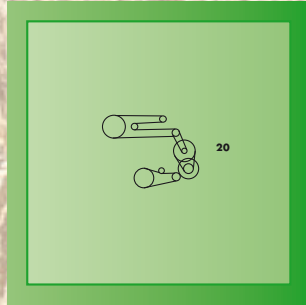
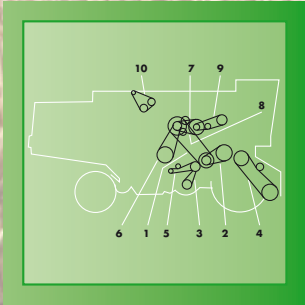

No.	Application	OEM - PN	Set	Optibelt AP-Nr.	EAN
1		4240023362	1	1001207	4014486497663
2		4240023387	1	1001956	4014486490633
3		4240023354	1	1001000	4014486497236
4		4240023395	1	1003652	4014486489491
5		4240044287	1	1002079	4014486475692
6		4240044295	1	1003680	4014486477061
7		4240044301	1	1002148	4014486476637
9		4240044270	2	1003005	4014486476729
10		9911861645	1	1002076	4014486475654
11		4240023370	1	1001990	4014486491104
12		4240044254	2	1002231	4014486477931
13		4240046545	2	1002989	4014486475593
14		4240040388	1	1002185	4014486477290
15		4240023395	1	1003652	4014486489491
16		4240044301	1	1002148	4014486476637
17		4240044262	2	1002131	4014486476361
19		4240043405	2	1003779	4014486476408
20		4240043413	1	1002142	4014486476545

FORTSCHRITT E 524, E 525

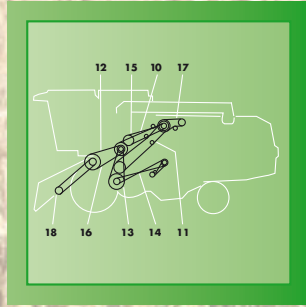
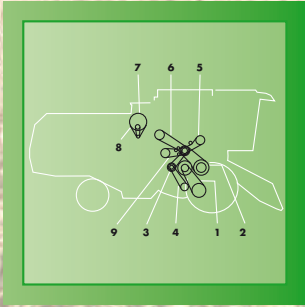

No.	Application	OEM - PN	Set	Optibelt AP-Nr.	EAN
10		4260699985	1	1001901	4014486489613
11		4260699960	1	1001915	4014486489811
15		4260699977	1	1001649	4014486486018
16		4260703942	1	1001869	4014486489095
18		4260715183	1	1001892	4014486489507
10		4260699985	1	1001901	4014486489613
11		4260699960	1	1001915	4014486489811
15		4260699977	1	1001649	4014486486018
16		4260703942	1	1001869	4014486489095
18		4260715183	1	1001892	4014486489507

JOHN DEERE 330



No.	Application	OEM - PN	Set	Optibelt AP-Nr.	EAN
1	REEL DRIVE VARIABLE SPEED	Z20459	1	1003583	4014486459029
2	STRAW ELEVATOR DRIVE	Z20460	1	1000697	4014486470789
3	REEL DRIVE	Z20562	1	1000753	4014486471526
4	HYDRAULIC PUMP DRIVE	Z23752	1	1000095	4014486460933
4	HYDRAULIC PUMP DRIVE	Z21171	1	1003371	4014486461190
4	HYDRAULIC PUMP DRIVE	Z21254	1	1003372	4014486461244
5	UNLOADING SYSTEM	Z21398	1	1000561	4014486468601
5	UNLOADING SYSTEM	Z21400	1	1003496	4014486468649
7	SICKLE KNIFE DRIVE	Z23693	1	1000695	4014486470765
9	FAN DRIVE VARIABLE SPEED	Z20459	1	1003583	4014486459029
10	FAN DRIVE	Z20703	1	1000679	4014486470529
11	CYLINDER DRIVE	Z20823	1	1003587	4014486460230
12	ROTARY SCREEN - ELEVATOR	Z20743	1	1003505	4014486469196

JOHN DEERE 430



No.	Application	OEM - PN	Set	Optibelt AP-Nr.	EAN
1	REEL DRIVE VARIABLE SPEED	Z20459	1	1003583	4014486459029
2	STRAW ELEVATOR DRIVE	Z20460	1	1000697	4014486470789
3	REEL DRIVE	Z20562	1	1000753	4014486471526
4	HYDRAULIC PUMP DRIVE	Z23752	1	1000095	4014486460933
4	HYDRAULIC PUMP DRIVE	Z21171	1	1003371	4014486461190
4	HYDRAULIC PUMP DRIVE	Z21254	1	1003372	4014486461244
5	UNLOADING SYSTEM	Z21398	1	1000561	4014486468601
5	UNLOADING SYSTEM	Z21400	1	1003496	4014486468649
7	SICKLE KNIFE DRIVE	Z23693	1	1000695	4014486470765
9	FAN DRIVE VARIABLE SPEED	Z20459	1	1003583	4014486459029
10	FAN DRIVE	Z20703	1	1000679	4014486470529
11	CYLINDER DRIVE	Z20823	1	1003587	4014486460230
12	ROTARY SCREEN - ELEVATOR	Z20743	1	1003505	4014486469196

JOHN DEERE 530



No.	Application	OEM - PN	Set	Optibelt AP-Nr.	EAN
1	REEL DRIVE VARIABLE SPEED	Z20459	1	1003583	4014486459029
2	REEL DRIVE	Z20562	1	1000753	4014486471526
3	HYDRAULIC PUMP DRIVE	Z21171	1	1003371	4014486461190
3	HYDRAULIC PUMP DRIVE	Z21254	1	1003372	4014486461244
4	UNLOADING SYSTEM	Z21398	1	1000561	4014486468601
4	UNLOADING SYSTEM	Z21400	1	1003496	4014486468649
6	SICKLE KNIFE DRIVE	Z21500	1	1001103	4014486496857
7	STRAW ELEVATOR DRIVE	Z21501	1	1001102	4014486496840
9	FAN DRIVE VARIABLE SPEED	Z20459	1	1003583	4014486459029
10	FAN DRIVE	Z20703	1	1000679	4014486470529
11	ROTARY SCREEN - ELEVATOR	Z20743	1	1003505	4014486469196
12	CYLINDER DRIVE	Z20823	1	1003587	4014486460230
13	HYDRAULIC PUMP DRIVE - ENGINE	Z22208	1	1003720	4014486494891

JOHN DEERE 630



No.	Application	OEM - PN	Set	Optibelt AP-Nr.	EAN
1	REEL DRIVE VARIABLE SPEED	Z20459	1	1003583	4014486459029
2	REEL DRIVE	Z20562	1	1000753	4014486471526
3	HYDRAULIC PUMP DRIVE	Z21171	1	1003371	4014486461190
3	HYDRAULIC PUMP DRIVE	Z21254	1	1003372	4014486461244
4	UNLOADING SYSTEM	Z21398	1	1000561	4014486468601
4	UNLOADING SYSTEM	Z21400	1	1003496	4014486468649
6	SICKLE KNIFE DRIVE	Z21500	1	1001103	4014486496857
7	STRAW ELEVATOR DRIVE	Z21501	1	1001102	4014486496840
9	FAN DRIVE VARIABLE SPEED	Z20459	1	1003583	4014486459029
10	FAN DRIVE	Z20703	1	1000679	4014486470529
11	ROTARY SCREEN - ELEVATOR	Z20743	1	1003505	4014486469196
12	CYLINDER DRIVE	Z20823	1	1003587	4014486460230
13	HYDRAULIC PUMP DRIVE - ENGINE	Z22208	1	1003720	4014486494891

JOHN DEERE 730



No.	Application	OEM - PN	Set	Optibelt AP-Nr.	EAN
1	REEL DRIVE VARIABLE SPEED	Z20459	1	1003583	4014486459029
2	REEL DRIVE	Z20562	1	1000753	4014486471526
3	HYDRAULIC PUMP DRIVE	Z21254	1	1003372	4014486461244
4	UNLOADING SYSTEM	Z21400	1	1003496	4014486468649
5	SICKLE KNIFE DRIVE	Z21501	1	1001102	4014486496840
5	SICKLE KNIFE DRIVE	Z21500	1	1001103	4014486496857
6	STRAW ELEVATOR DRIVE	Z21501	1	1001102	4014486496840
9	FAN DRIVE VARIABLE SPEED	Z20459	1	1003583	4014486459029
10	FAN DRIVE	Z20703	1	1000679	4014486470529
11	ROTARY SCREEN - ELEVATOR	Z20743	1	1003505	4014486469196
12	CYLINDER DRIVE	Z20823	1	1003587	4014486460230
13	HYDRAULIC PUMP DRIVE - ENGINE	Z22208	1	1003720	4014486494891

BISO - Schrattecker
BIZON
CASE INTL. HARVESTER
CLAAS
DEUTZ-FAHR
DRONNING-BORG
FENDT
FORTSCHRITT
JOHN DEERE
KRONE
LAVERDA
MASSEY FERGUSON
NEW HOLLAND
ROSTSELMASH

JOHN DEERE 930



No.	Application	OEM - PN	Set	Optibelt AP-Nr.	EAN
1	REEL DRIVE	Z20562	1	1000753	4014486471526
2	REEL DRIVE VARIABLE SPEED	Z30692	1	1001407	4014486459142
2	REEL DRIVE VARIABLE SPEED	Z20459	1	1003583	4014486459029
3	SICKLE KNIFE DRIVE	Z23693	1	1000695	4014486470765
4	STRAW ELEVATOR DRIVE	Z21501	1	1001102	4014486496840
4	STRAW ELEVATOR DRIVE	Z30130	1	1001111	4014486496949
7	UNLOADING SYSTEM	Z21400	1	1003496	4014486468649
9	STRAW WALKER DRIVE	Z25473	1	1003494	4014486468540
10	PURIFY DRIVE	Z31283	1	1000038	4014486460759
11	FAN DRIVE	Z20703	1	1000679	4014486470529
12	FAN DRIVE VARIABLE SPEED	Z20459	1	1003583	4014486459029
13	CYLINDER VARIATOR DRIVE	Z20823	1	1003587	4014486460230
14	ROTARY SCREEN DRIVE	Z28458	1	1000594	4014486469233

JOHN DEERE 940



No.	Application	OEM - PN	Set	Optibelt AP-Nr.	EAN
1	REEL DRIVE	Z20562	1	1000753	4014486471526
2	REEL DRIVE VARIABLE SPEED	Z30692	1	1001407	4014486459142
2	REEL DRIVE VARIABLE SPEED	Z20459	1	1003583	4014486459029
3	SICKLE KNIFE DRIVE	Z23693	1	1000695	4014486470765
4	STRAW ELEVATOR DRIVE	Z21501	1	1001102	4014486496840
4	STRAW ELEVATOR DRIVE	Z30130	1	1001111	4014486496949
7	UNLOADING SYSTEM	Z21400	1	1003496	4014486468649
9	STRAW WALKER DRIVE	Z25473	1	1003494	4014486468540
10	PURIFY DRIVE	Z31283	1	1000038	4014486460759
11	FAN DRIVE	Z20703	1	1000679	4014486470529
12	FAN DRIVE VARIABLE SPEED	Z20459	1	1003583	4014486459029
13	CYLINDER VARIATOR DRIVE	Z20823	1	1003587	4014486460230
14	ROTARY SCREEN DRIVE	Z28458	1	1000594	4014486469233

JOHN DEERE 950



No.	Application	OEM - PN	Set	Optibelt AP-Nr.	EAN
1	REEL DRIVE	Z20562	1	1000753	4014486471526
2	REEL DRIVE VARIABLE SPEED	Z30692	1	1001407	4014486459142
2	REEL DRIVE VARIABLE SPEED	Z20459	1	1003583	4014486459029
3	SICKLE KNIFE DRIVE	Z30130	1	1001111	4014486496949
4	STRAW ELEVATOR DRIVE	Z21501	1	1001102	4014486496840
6	THRESHING DRUM VARIATOR DRIVE	Z32173	1	1001979	4014486490961
6	THRESHING DRUM VARIATOR DRIVE	Z29962	1	1004146	4014486523270
7	UNLOADING SYSTEM	Z21400	1	1003496	4014486468649
10	PURIFY DRIVE	Z31283	1	1000038	4014486460759
11	FAN DRIVE	Z20703	1	1000679	4014486470529
12	FAN DRIVE VARIABLE SPEED	Z20459	1	1003583	4014486459029
13	CYLINDER VARIATOR DRIVE	Z20823	1	1003587	4014486460230
14	ROTARY SCREEN DRIVE	Z28458	1	1000594	4014486469233
16	STRAW WALKER DRIVE	Z25473	1	1003494	4014486468540

JOHN DEERE 952



No.	Application	OEM - PN	Set	Optibelt AP-Nr.	EAN
1	REEL DRIVE	Z20562	1	1000753	4014486471526
2	REEL DRIVE VARIABLE SPEED	Z30692	1	1001407	4014486459142
2	REEL DRIVE VARIABLE SPEED	Z20459	1	1003583	4014486459029
3	SICKLE KNIFE DRIVE	Z30130	1	1001111	4014486496949
4	STRAW ELEVATOR DRIVE	Z21501	1	1001102	4014486496840
4	STRAW ELEVATOR DRIVE	Z32568	1	1004129	4014486523119
7	UNLOADING SYSTEM	Z21400	1	1003496	4014486468649
9	STRAW CHOPPER DRIVE	Z33774	1	1000401	4014486466645
11	PURIFY DRIVE	Z31283	1	1000038	4014486460759
12	FAN DRIVE	Z34405	1	1000675	4014486470475
13	FAN DRIVE VARIABLE SPEED	Z20459	1	1003583	4014486459029
14	CYLINDER VARIATOR DRIVE	Z20823	1	1003587	4014486460230
15	WATERPUMP DRIVE	Z32190	1	1000002	4014486458985
15	ROTARY SCREEN DRIVE	Z20743	1	1003505	4014486469196

JOHN DEERE 955



No.	Application	OEM - PN	Set	Optibelt AP-Nr.	EAN
1	REEL DRIVE	Z20562	1	1000753	4014486471526
2	REEL DRIVE VARIABLE SPEED	Z30692	1	1001407	4014486459142
2	REEL DRIVE VARIABLE SPEED	Z20459	1	1003583	4014486459029
3	SICKLE KNIFE DRIVE	Z30130	1	1001111	4014486496949
4	STRAW ELEVATOR DRIVE	Z21501	1	1001102	4014486496840
4	STRAW ELEVATOR DRIVE	Z32568	1	1004129	4014486523119
7	UNLOADING SYSTEM	Z21400	1	1003496	4014486468649
9	STRAW CHOPPER DRIVE	Z33774	1	1000401	4014486466645
10	PURIFY DRIVE	Z31283	1	1000038	4014486460759
10	STRAW WALKER DRIVE	Z32883	1	1000157	4014486461794
11	FAN DRIVE	Z34405	1	1000675	4014486470475
12	FAN DRIVE VARIABLE SPEED	Z20459	1	1003583	4014486459029
13	CYLINDER VARIATOR DRIVE	Z20823	1	1003587	4014486460230
15	WATERPUMP DRIVE	Z32190	1	1000002	4014486458985
15	ROTARY SCREEN DRIVE	Z20743	1	1003505	4014486469196

JOHN DEERE 960



No.	Application	OEM - PN	Set	Optibelt AP-Nr.	EAN
1	REEL DRIVE	Z20562	1	1000753	4014486471526
2	REEL DRIVE VARIABLE SPEED	Z30692	1	1001407	4014486459142
2	REEL DRIVE VARIABLE SPEED	Z20459	1	1003583	4014486459029
3	SICKLE KNIFE DRIVE	Z30130	1	1001111	4014486496949
4	STRAW ELEVATOR DRIVE	Z21501	1	1001102	4014486496840
6	THRESHING DRUM VARIATOR DRIVE	Z32173	1	1001979	4014486490961
6	THRESHING DRUM VARIATOR DRIVE	Z29962	1	1004146	4014486523270
7	UNLOADING SYSTEM	Z21400	1	1003496	4014486468649
10	PURIFY DRIVE	Z31283	1	1000038	4014486460759
11	FAN DRIVE	Z20703	1	1000679	4014486470529
12	FAN DRIVE VARIABLE SPEED	Z20459	1	1003583	4014486459029
13	CYLINDER VARIATOR DRIVE	Z20823	1	1003587	4014486460230
14	ROTARY SCREEN DRIVE	Z28458	1	1000594	4014486469233
16	STRAW WALKER DRIVE	Z25473	1	1003494	4014486468540

JOHN DEERE 965



No.	Application	OEM - PN	Set	Optibelt AP-Nr.	EAN
1	REEL DRIVE	Z20562	1	1000753	4014486471526
2	REEL DRIVE VARIABLE SPEED	Z20459	1	1003583	4014486459029
3	MAIN DRIVE	Z33790	1	1001995	4014486491180
4	UNLOADING SYSTEM	Z33368	1	1000603	4014486469370
5	HYDRAULIC PUMP DRIVE	Z34828	1	1003397	4014486462821
6	TRACTION DRIVE	AZ22914	2	1002915	4014486496918
8	STRAW ELEVATOR DRIVE	Z21500	1	1001103	4014486496857
11	PURIFY DRIVE	Z31283	1	1000038	4014486460759
12	COUNTERSHAFT - PURIFY DRIVE	Z32190	1	1000002	4014486458985
13	CYLINDER DRIVE	Z20823	1	1003587	4014486460230
14	FAN DRIVE	Z34405	1	1000675	4014486470475
15	SICKLE KNIFE DRIVE	Z30130	1	1001111	4014486496949

JOHN DEERE 970



No.	Application	OEM - PN	Set	Optibelt AP-Nr.	EAN
1	REEL DRIVE	Z20562	1	1000753	4014486471526
2	REEL DRIVE VARIABLE SPEED	Z30692	1	1001407	4014486459142
2	REEL DRIVE VARIABLE SPEED	Z20459	1	1003583	4014486459029
3	SICKLE KNIFE DRIVE	Z30130	1	1001111	4014486496949
4	STRAW ELEVATOR DRIVE	Z21501	1	1001102	4014486496840
6	THRESHING DRUM VARIATOR DRIVE	Z32173	1	1001979	4014486490961
6	THRESHING DRUM VARIATOR DRIVE	Z29962	1	1004146	4014486523270
7	UNLOADING SYSTEM	Z21400	1	1003496	4014486468649
10	PURIFY DRIVE	Z31283	1	1000038	4014486460759
11	FAN DRIVE	Z20703	1	1000679	4014486470529
12	FAN DRIVE VARIABLE SPEED	Z20459	1	1003583	4014486459029
13	CYLINDER VARIATOR DRIVE	Z20823	1	1003587	4014486460230
14	ROTARY SCREEN DRIVE	Z28458	1	1000594	4014486469233
16	STRAW WALKER DRIVE	Z25473	1	1003494	4014486468540

JOHN DEERE 975



No.	Application	OEM - PN	Set	Optibelt AP-Nr.	EAN
1	REEL DRIVE	Z20562	1	1000753	4014486471526
2	REEL DRIVE VARIABLE SPEED	Z20459	1	1003583	4014486459029
3	MAIN DRIVE	Z33790	1	1001995	4014486491180
4	UNLOADING SYSTEM	Z33368	1	1000603	4014486469370
5	HYDRAULIC PUMP DRIVE	Z34828	1	1003397	4014486462821
6	TRACTION DRIVE	AZ22914	2	1002915	4014486496918
8	STRAW ELEVATOR DRIVE	Z21500	1	1001103	4014486496857
11	PURIFY DRIVE	Z31283	1	1000038	4014486460759
12	COUNTERSHAFT - PURIFY DRIVE	Z32190	1	1000002	4014486458985
13	CYLINDER DRIVE	Z20823	1	1003587	4014486460230
14	FAN DRIVE	Z34405	1	1000675	4014486470475
15	SICKLE KNIFE DRIVE	Z30130	1	1001111	4014486496949

JOHN DEERE 985



No.	Application	OEM - PN	Set	Optibelt AP-Nr.	EAN
1	REEL DRIVE	Z20562	1	1000753	4014486471526
2	REEL DRIVE	Z30692	1	1001407	4014486459142
3	MAIN	Z33790	1	1001995	4014486491180
4	UNLOADING DRIVE	Z33368	1	1000603	4014486469370
5	HYDRAULIC PUMP DRIVE	Z34828	1	1003397	4014486462821
6	STRAW DISCHARGE	Z33605	1	1000162	4014486461848
7	HYDRAULIC PUMP DRIVE - ENGINE	CA20518	1	1003386	4014486462425
9	TRACTION (UPPER)	AZ22914	2	1002915	4014486496918
10	TRACTION (LOWER)	Z34099	1	1001523	4014486460421
11	MAIN DRIVE	Z38186	1	1001647	4014486485998
14	PURIFY DRIVE	Z37192	1	1004106	4014486522815
16	CYLINDER	Z37473	1	1003589	4014486460315
18	FAN DRIVE VARIABLE SPEED	Z20459	1	1003583	4014486459029

JOHN DEERE 1032

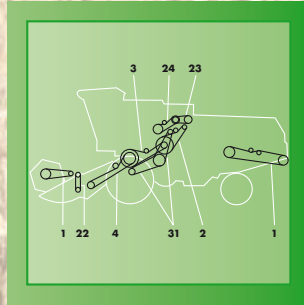
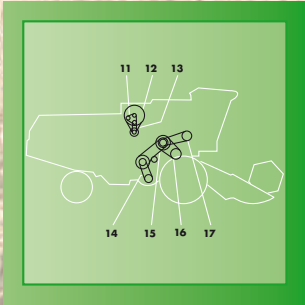

No.	Application	OEM - PN	Set	Optibelt AP-Nr.	EAN
1	STRAW WALKER DRIVE	Z33774	1	1000401	4014486466645
2		Z46222	1	1001861	4014486488975
3	LEAD-IN DRIVE	Z20460	1	1000697	4014486470789
3	LEAD-IN DRIVE	Z21501	1	1001102	4014486496840
3	LEAD-IN DRIVE	Z38186	1	1001647	4014486485998
4	CUTTING TABLE DRIVE	Z23693	1	1000695	4014486470765
4	CUTTING TABLE DRIVE	Z39313	1	1001109	4014486496925
12	ROTARY SCREEN DRIVE	Z31283	1	1000038	4014486460759
13	ROTARY SCREEN DRIVE	Z32190	1	1000002	4014486458985
14	FAN DRIVE VARIABLE SPEED	Z41178	1	1001396	4014486459012
15	FAN DRIVE VARIABLE SPEED	Z34405	1	1000675	4014486470475
16		Z53288	1	1001507	4014486460223
17	ELEVATOR DRIVE UNIT	Z20743	1	1003505	4014486469196
21		Z44740	1	1000747	4014486471441
22	REEL DRIVE VARIABLE SPEED	Z36813	1	1001397	4014486459036
23	HYDRAULIC PUMP DRIVE	Z42382	1	1002811	4014486462920
24	DISCHARGE BEATER DRIVE	Z43253	1	1003492	4014486468465
31	MAIN DRIVE	Z36120	1	1001438	4014486459463

JOHN DEERE 1042

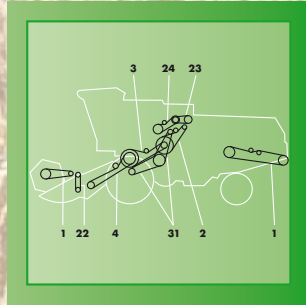
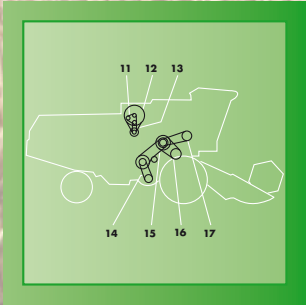

No.	Application	OEM - PN	Set	Optibelt AP-Nr.	EAN
1	STRAW WALKER DRIVE	Z33774	1	1000401	4014486466645
2		Z46222	1	1001861	4014486488975
3	LEAD-IN DRIVE	Z20460	1	1000697	4014486470789
3	LEAD-IN DRIVE	Z21501	1	1001102	4014486496840
3	LEAD-IN DRIVE	Z38186	1	1001647	4014486485998
4	CUTTING TABLE DRIVE	Z23693	1	1000695	4014486470765
4	CUTTING TABLE DRIVE	Z39313	1	1001109	4014486496925
12	ROTARY SCREEN DRIVE	Z31283	1	1000038	4014486460759
13	ROTARY SCREEN DRIVE	Z32190	1	1000002	4014486458985
14	FAN DRIVE VARIABLE SPEED	Z41178	1	1001396	4014486459012
15	FAN DRIVE VARIABLE SPEED	Z34405	1	1000675	4014486470475
16		Z53288	1	1001507	4014486460223
17	ELEVATOR DRIVE UNIT	Z20743	1	1003505	4014486469196
21		Z44740	1	1000747	4014486471441
22	REEL DRIVE VARIABLE SPEED	Z36813	1	1001397	4014486459036
23	HYDRAULIC PUMP DRIVE	Z42382	1	1002811	4014486462920
24	DISCHARGE BEATER DRIVE	Z43253	1	1003492	4014486468465
31	MAIN DRIVE	Z36120	1	1001438	4014486459463

JOHN DEERE 1052

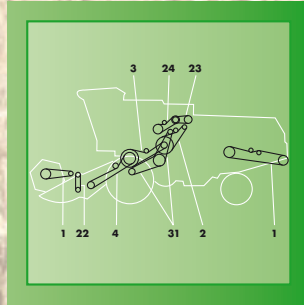
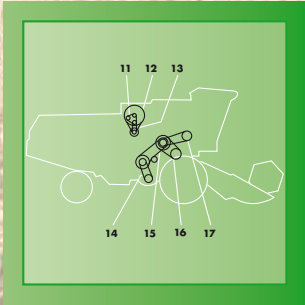

No.	Application	OEM - PN	Set	Optibelt AP-Nr.	EAN
1	STRAW WALKER DRIVE	Z33774	1	1000401	4014486466645
2		Z46222	1	1001861	4014486488975
3	LEAD-IN DRIVE	Z20460	1	1000697	4014486470789
3	LEAD-IN DRIVE	Z21501	1	1001102	4014486496840
3	LEAD-IN DRIVE	Z38186	1	1001647	4014486485998
4	CUTTING TABLE DRIVE	Z23693	1	1000695	4014486470765
4	CUTTING TABLE DRIVE	Z39313	1	1001109	4014486496925
12	ROTARY SCREEN DRIVE	Z31283	1	1000038	4014486460759
13	ROTARY SCREEN DRIVE	Z32190	1	1000002	4014486458985
14	FAN DRIVE VARIABLE SPEED	Z41178	1	1001396	4014486459012
15	FAN DRIVE VARIABLE SPEED	Z34405	1	1000675	4014486470475
16		Z53288	1	1001507	4014486460223
17	ELEVATOR DRIVE UNIT	Z20743	1	1003505	4014486469196
21		Z44740	1	1000747	4014486471441
22	REEL DRIVE VARIABLE SPEED	Z36813	1	1001397	4014486459036
23	HYDRAULIC PUMP DRIVE	Z42382	1	1002811	4014486462920
24	DISCHARGE BEATER DRIVE	Z43253	1	1003492	4014486468465
31	MAIN DRIVE	Z36120	1	1001438	4014486459463

JOHN DEERE 1055

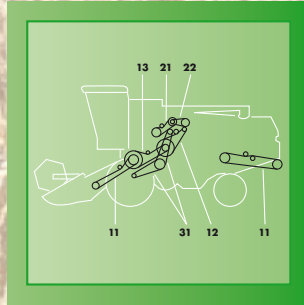
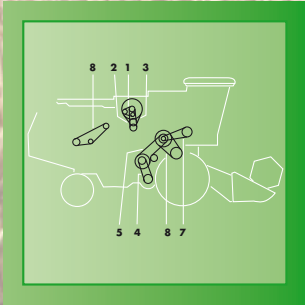

No.	Application	OEM - PN	Set	Optibelt AP-Nr.	EAN
2	ROTARY SCREEN DRIVE	Z31283	1	1000038	4014486460759
3	ROTARY SCREEN DRIVE	Z32190	1	1000002	4014486458985
4	FAN DRIVE VARIABLE SPEED	Z41178	1	1001396	4014486459012
5	FAN DRIVE VARIABLE SPEED	Z34405	1	1000675	4014486470475
6		Z53288	1	1001507	4014486460223
7	ELEVATOR DRIVE UNIT	Z20743	1	1003505	4014486469196
8		Z35965	1	1000153	4014486461756
11	STRAW WALKER DRIVE	Z33774	1	1000401	4014486466645
12		Z46222	1	1001861	4014486488975
13	LEAD-IN DRIVE	Z21501	1	1001102	4014486496840
13	LEAD-IN DRIVE	Z38186	1	1001647	4014486485998
14	CUTTING TABLE DRIVE	Z39313	1	1001109	4014486496925
14	CUTTING TABLE DRIVE	Z39312	1	1001118	4014486497038
21	DISCHARGE BEATER DRIVE	Z43253	1	1003492	4014486468465
22	HYDRAULIC PUMP DRIVE	Z42382	1	1002811	4014486462920

JOHN DEERE 1065

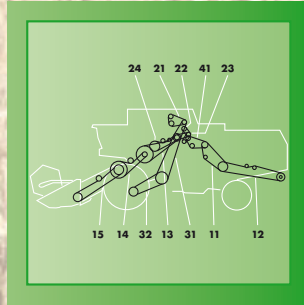
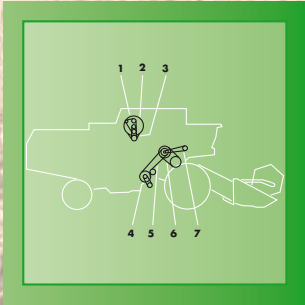

No.	Application	OEM - PN	Set	Optibelt AP-Nr.	EAN
1	CUTTING TABLE DRIVE LEAD-IN	Z33790	1	1001995	4014486491180
2	DISCHARGE BEATER DRIVE	Z43253	1	1003492	4014486468465
4	HYDROSTATIC PUMP DRIVE	Z34828	1	1003397	4014486462821
5	SHAKER SHAFT DRIVE	Z35965	1	1000153	4014486461756
6	MAIN DRIVE	Z34099	1	1001523	4014486460421
7	LEAD-IN DRIVE	Z21501	1	1001102	4014486496840
8	LEAD-IN DRIVE	Z32568	1	1004129	4014486523119
9	CUTTING TABLE DRIVE	Z39313	1	1001109	4014486496925
10	CUTTING TABLE DRIVE	Z39314	1	1001121	4014486497076
12	ROTARY SCREEN DRIVE	Z31283	1	1000038	4014486460759
13	ROTARY SCREEN DRIVE	Z32190	1	1000002	4014486458985
14	CYLINDER VARIATOR DRIVE	Z20823	1	1003587	4014486460230
15	FAN DRIVE VARIABLE SPEED	Z34405	1	1000675	4014486470475
16	FAN DRIVE VARIABLE SPEED	Z41178	1	1001396	4014486459012
18	REEL DRIVE VARIABLE SPEED	Z36813	1	1001397	4014486459036
19	REEL DRIVE VARIABLE SPEED	Z20562	1	1000753	4014486471526
20	MAIN DRIVE	AZ22914	2	1002915	4014486496918
21	STRAW WALKER DRIVE	Z33774	1	1000401	4014486466645

JOHN DEERE 1068

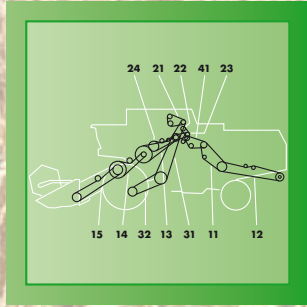
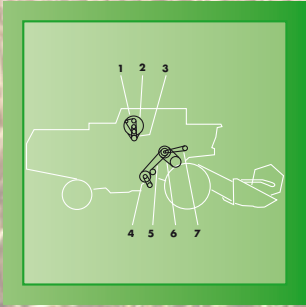

No.	Application	OEM - PN	Set	Optibelt AP-Nr.	EAN
1	FAN DRIVE	AR72036	1	1002351	4014486478846
2	ROTARY SCREEN DRIVE	Z34786	1	1000040	4014486460773
3	ROTARY SCREEN DRIVE	Z32190	1	1000002	4014486458985
4	FAN DRIVE VARIABLE SPEED	Z41178	1	1001396	4014486459012
5	FAN DRIVE VARIABLE SPEED	Z34405	1	1000675	4014486470475
6	CYLINDER VARIATOR DRIVE	Z53288	1	1001507	4014486460223
7		Z45026	1	1000261	4014486464177
11	SHAKER SHAFT DRIVE	Z35965	1	1000153	4014486461756
12	STRAW WALKER DRIVE	Z33774	1	1000401	4014486466645
13	CUTTING TABLE DRIVE LEAD-IN	Z33790	1	1001995	4014486491180
14	LEAD-IN DRIVE (GRAIN)	Z21501	1	1001102	4014486496840
14	LEAD-IN DRIVE (MAIZE)	Z38186	1	1001647	4014486485998
15	CUTTING TABLE DRIVE	Z39313	1	1001109	4014486496925
15	CUTTING TABLE DRIVE	Z39312	1	1001118	4014486497038
15	CUTTING TABLE DRIVE	Z39314	1	1001121	4014486497076
21	AIR CONDITIONING COMPRESSOR DRIVE SUB. FOR Z41889	Z42756	1	1002350	4014486478839
22	AIR CONDITIONING COMPRESSOR DRIVE (FROM NR. 33563)	Z45482	1	1003400	4014486462906
23	HYDRAULIC PUMP DRIVE	Z34828	1	1003397	4014486462821
24		Z47911	1	1000604	4014486469363
32	MAIN DRIVE	Z34099	1	1001523	4014486460421
41		Z43863	1	1000036	4014486460735

JOHN DEERE 1072



No.	Application	OEM - PN	Set	Optibelt AP-Nr.	EAN
1	REEL DRIVE VARIABLE SPEED	Z33790	1	1001995	4014486491180
4	HYDROSTATIC PUMP DRIVE	Z34828	1	1003397	4014486462821
5	SHAKER SHAFT DRIVE	Z35965	1	1000153	4014486461756
6	MAIN DRIVE	Z21501	1	1001102	4014486496840
8	CUTTING TABLE DRIVE	Z39313	1	1001109	4014486496925
10	ROTARY SCREEN DRIVE	Z31283	1	1000038	4014486460759
11	ROTARY SCREEN DRIVE	Z32190	1	1000002	4014486458985
12	CYLINDER VARIATOR DRIVE	Z20823	1	1003587	4014486460230
13	FAN DRIVE VARIABLE SPEED	Z34405	1	1000675	4014486470475
16	REEL DRIVE VARIABLE SPEED	Z36813	1	1001397	4014486459036
17	REEL DRIVE VARIABLE SPEED	Z20562	1	1000753	4014486471526
22	STRAW WALKER DRIVE	Z33774	1	1000401	4014486466645
23	MAIN DRIVE	Z33967	1	1001497	4014486460100

JOHN DEERE 1075



No.	Application	OEM - PN	Set	Optibelt AP-Nr.	EAN
1	CUTTING TABLE DRIVE LEAD-IN	Z33790	1	1001995	4014486491180
2	DISCHARGE BEATER DRIVE	Z33368	1	1000603	4014486469370
4	HYDROSTATIC PUMP DRIVE	Z34828	1	1003397	4014486462821
5	SHAKER SHAFT DRIVE	Z35965	1	1000153	4014486461756
6	MAIN DRIVE	Z34099	1	1001523	4014486460421
7	LEAD-IN DRIVE	Z21501	1	1001102	4014486496840
7	LEAD-IN DRIVE	Z38186	1	1001647	4014486485998
8	CUTTING TABLE DRIVE	Z39314	1	1001121	4014486497076
9	FAN DRIVE	AR72036	1	1002351	4014486478846
12	ROTARY SCREEN DRIVE	Z34786	1	1000040	4014486460773
13	ROTARY SCREEN DRIVE	Z32190	1	1000002	4014486458985
14	CYLINDER VARIATOR DRIVE	Z37473	1	1003589	4014486460315
15	FAN DRIVE VARIABLE SPEED	Z34405	1	1000675	4014486470475
16	FAN DRIVE VARIABLE SPEED	Z41178	1	1001396	4014486459012
18	REEL DRIVE VARIABLE SPEED	Z36813	1	1001397	4014486459036
19	REEL DRIVE VARIABLE SPEED	Z20562	1	1000753	4014486471526
20	MAIN DRIVE	AZ22914	2	1002915	4014486496918
21	STRAW WALKER DRIVE	Z33774	1	1000401	4014486466645

JOHN DEERE 1085



No.	Application	OEM - PN	Set	Optibelt AP-Nr.	EAN
2	DISCHARGE BEATER DRIVE	Z33368	1	1000603	4014486469370
3	AIR CONDITIONING COMPRESSOR DRIVE	Z41932	1	1000229	4014486463118
4	HYDROSTATIC PUMP DRIVE	Z34828	1	1003397	4014486462821
5	SHAKER SHAFT DRIVE	Z35965	1	1000153	4014486461756
6	MAIN DRIVE	Z34099	1	1001523	4014486460421
7	LEAD-IN DRIVE	Z38186	1	1001647	4014486485998
10	ROTARY SCREEN DRIVE	Z38704	1	1000039	4014486460766
12	CYLINDER VARIATOR DRIVE	Z37473	1	1003589	4014486460315
13	FAN DRIVE VARIABLE SPEED	Z34405	1	1000675	4014486470475
14	FAN DRIVE VARIABLE SPEED	Z41178	1	1001396	4014486459012
16	REEL DRIVE VARIABLE SPEED	Z36813	1	1001397	4014486459036
17	REEL DRIVE VARIABLE SPEED	Z20562	1	1000753	4014486471526
19	MAIN DRIVE	AZ22914	2	1002915	4014486496918
22	STRAW WALKER DRIVE	Z33774	1	1000401	4014486466645

JOHN DEERE 1088



No.	Application	OEM - PN	Set	Optibelt AP-Nr.	EAN
1		Z51212	1	1001027	4014486487800
3		Z34828	1	1003397	4014486462821
4		Z42757	1	1003343	4014486462975
5		Z33774	1	1000401	4014486466645
9		Z46709	1	1001832	4014486488555
10		Z43890	1	1003643	4014486489156
11		Z46463	1	1001261	4014486492200
12		Z46365	1	1001404	4014486459104
13		Z44936	1	1001542	4014486460612
15		Z42756	1	1002350	4014486478839
16		Z43863	1	1000036	4014486460735
17		Z38704	1	1000039	4014486460766

BISO - Schrattecker
 BIZON
 CASE INTL. HARVESTER
 CLAAS
 DEUTZ-FAHR
 DRONNING-BORG
 FENDT
 FORTSCHRITT
 JOHN DEERE
 KRONE
 LAVERDA
 MASSEY FERGUSON
 NEW HOLLAND
 ROSTSELMASH

JOHN DEERE 1155



No.	Application	OEM - PN	Set	Optibelt AP-Nr.	EAN
1		AR72036	1	1002351	4014486478846
2		Z31283	1	1000038	4014486460759
2		Z38704	1	1000039	4014486460766
4		Z20459	1	1003583	4014486459029
5		Z34405	1	1000675	4014486470475
6		Z53288	1	1001507	4014486460223
7		Z20743	1	1003505	4014486469196
8		Z35965	1	1000153	4014486461756
11		Z33774	1	1000401	4014486466645
12		Z46222	1	1001861	4014486488975
13		Z21501	1	1001102	4014486496840
14		Z39313	1	1001109	4014486496925
14		Z39312	1	1001118	4014486497038
21		Z43253	1	1003492	4014486468465
22		Z42382	1	1002811	4014486462920

JOHN DEERE 1157



No.	Application	OEM - PN	Set	Optibelt AP-Nr.	EAN
1		AR72036	1	1002351	4014486478846
2		Z31283	1	1000038	4014486460759
2		Z38704	1	1000039	4014486460766
4		Z20459	1	1003583	4014486459029
5		Z34405	1	1000675	4014486470475
6		Z53288	1	1001507	4014486460223
7		Z20743	1	1003505	4014486469196
8		Z35965	1	1000153	4014486461756
11		Z33774	1	1000401	4014486466645
12		Z46222	1	1001861	4014486488975
13		Z21501	1	1001102	4014486496840
14		Z39313	1	1001109	4014486496925
14		Z39312	1	1001118	4014486497038
21		Z43253	1	1003492	4014486468465
22		Z42382	1	1002811	4014486462920

JOHN DEERE 1158



No.	Application	OEM - PN	Set	Optibelt AP-Nr.	EAN
1		AR72036	1	1002351	4014486478846
2		Z31283	1	1000038	4014486460759
2		Z38704	1	1000039	4014486460766
4		Z20459	1	1003583	4014486459029
5		Z34405	1	1000675	4014486470475
6		Z53288	1	1001507	4014486460223
7		Z20743	1	1003505	4014486469196
8		Z35965	1	1000153	4014486461756
11		Z33774	1	1000401	4014486466645
12		Z46222	1	1001861	4014486488975
13		Z21501	1	1001102	4014486496840
14		Z39313	1	1001109	4014486496925
14		Z39312	1	1001118	4014486497038
21		Z43253	1	1003492	4014486468465
22		Z42382	1	1002811	4014486462920

JOHN DEERE 1170

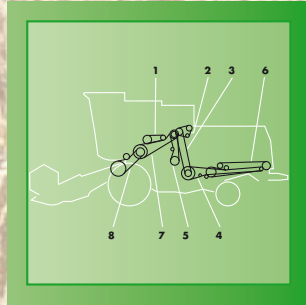
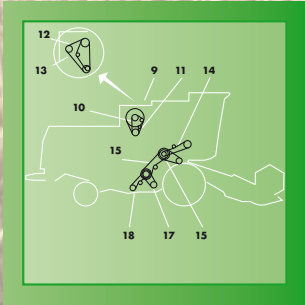

No.	Application	OEM - PN	Set	Optibelt AP-Nr.	EAN
5		Z46709	1	1001832	4014486488555
7		Z46463	1	1001261	4014486492200
8		Z43890	1	1003643	4014486489156
13		R123451	1	1003150	4014486481099
14		Z45026	1	1000261	4014486464177
16		Z44936	1	1001542	4014486460612
17		Z41178	1	1001396	4014486459012
19		Z46709	1	1001832	4014486488555

JOHN DEERE 2054

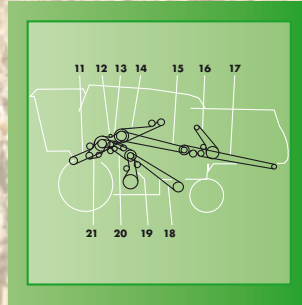
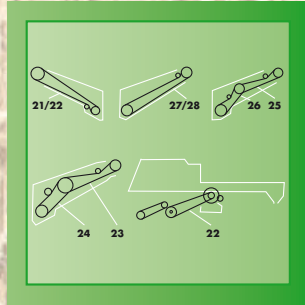
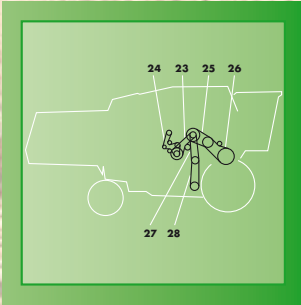

No.	Application	OEM - PN	Set	Optibelt AP-Nr.	EAN
1		Z55801	1	1000786	4014486472028
1		Z54406	1	1001122	4014486497083
1		Z61151	1	1001761	4014486487442
2		Z58752	1	1000788	4014486472042
2		Z59419	1	1001125	4014486497113
3		Z59556	1	1000635	4014486469899
3		Z63005	1	1000648	4014486470093
4		Z59557	1	1001388	4014486475043
5		Z44936	1	1001542	4014486460612
6		Z61858	1	1001973	4014486490886
7		Z62110	1	1001423	4014486459302
8		Z62111	1	1001432	4014486459401
11		Z59344	1	1003858	4014486519907
13		Z64912	1	1001751	4014486519525
13		Z61150	1	1001754	4014486519532
13		Z52909	1	1003856	4014486496680
14		Z61857	1	1001190	4014486520422
15		Z59286	1	1001911	4014486489736
16		Z59114	1	1000324	4014486465488
17		Z59342	1	1003622	4014486487114
18		Z60135	1	1000395	4014486466584
19		Z59322	1	1000640	4014486469981

JOHN DEERE 2054

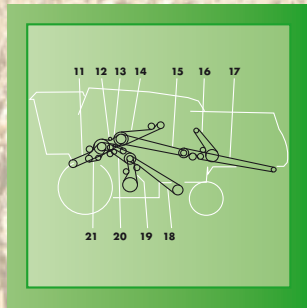
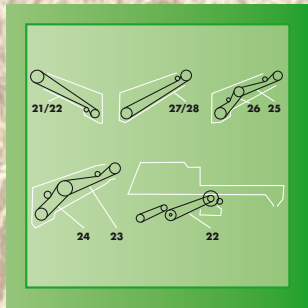
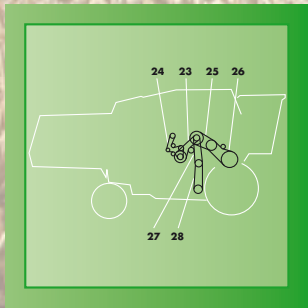

20		Z56959	1	1001089	4014486496710
21		Z56421	1	1001084	4014486496666
22		Z48212	1	1001769	4014486519600
23		Z61152	1	1001764	4014486487473
23		Z60931	1	1003623	4014486487503
24		Z61154	1	1001448	4014486459562
24		Z62211	1	1001449	4014486459579
25		Z54807	1	1001096	4014486496789
25		Z61152	1	1001764	4014486487473
25		Z60931	1	1003623	4014486487503
25		Z58751	1	1004084	4014486520453
26		Z55459	1	1001085	4014486496673
26		Z61153	1	1001753	4014486487367
26		Z61827	1	1001755	4014486519549
26		Z62213	1	1003856	4014486496680
27		Z54406	1	1001122	4014486497083
27		Z62214	1	1001127	4014486497137
27		Z62551	1	1001784	4014486519655
28		Z60930	1	1001784	4014486519655
28		Z62552	1	1001786	4014486519679

JOHN DEERE 2056

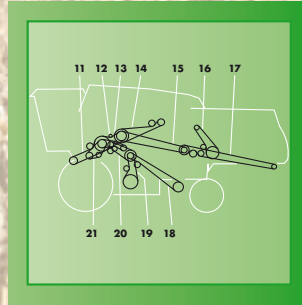
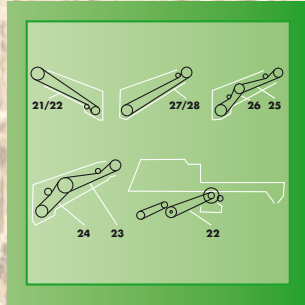
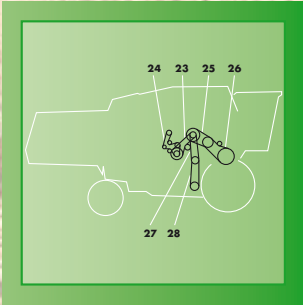

No.	Application	OEM - PN	Set	Optibelt AP-Nr.	EAN
1		Z55801	1	1000786	4014486472028
1		Z54406	1	1001122	4014486497083
1		Z61151	1	1001761	4014486487442
2		Z58752	1	1000788	4014486472042
2		Z59419	1	1001125	4014486497113
3		Z59556	1	1000635	4014486469899
3		Z63005	1	1000648	4014486470093
4		Z59557	1	1001388	4014486475043
5		Z44936	1	1001542	4014486460612
6		Z61858	1	1001973	4014486490886
7		Z62110	1	1001423	4014486459302
8		Z62111	1	1001432	4014486459401
11		Z59344	1	1003858	4014486519907
13		Z64912	1	1001751	4014486519525
13		Z61150	1	1001754	4014486519532
13		Z52909	1	1003856	4014486496680
14		Z61857	1	1001190	4014486520422
15		Z59286	1	1001911	4014486489736
16		Z59114	1	1000324	4014486465488
17		Z59342	1	1003622	4014486487114
18		Z60135	1	1000395	4014486466584
19		Z59322	1	1000640	4014486469981

JOHN DEERE 2056

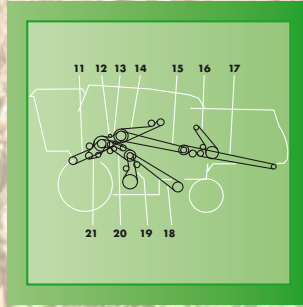
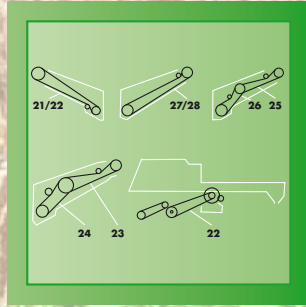
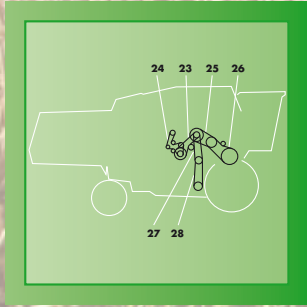

20		Z56959	1	1001089	4014486496710
21		Z56421	1	1001084	4014486496666
22		Z48212	1	1001769	4014486519600
23		Z61152	1	1001764	4014486487473
23		Z60931	1	1003623	4014486487503
24		Z61154	1	1001448	4014486459562
24		Z62211	1	1001449	4014486459579
25		Z54807	1	1001096	4014486496789
25		Z61152	1	1001764	4014486487473
25		Z60931	1	1003623	4014486487503
25		Z58751	1	1004084	4014486520453
26		Z55459	1	1001085	4014486496673
26		Z61153	1	1001753	4014486487367
26		Z61827	1	1001755	4014486519549
26		Z62213	1	1003856	4014486496680
27		Z54406	1	1001122	4014486497083
27		Z62214	1	1001127	4014486497137
27		Z62551	1	1001784	4014486519655
28		Z60930	1	1001784	4014486519655
28		Z62552	1	1001786	4014486519679

JOHN DEERE 2058

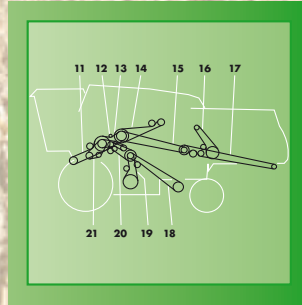
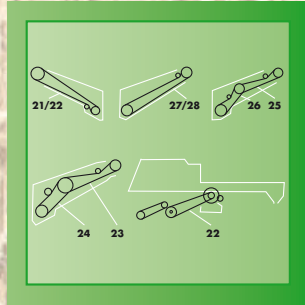
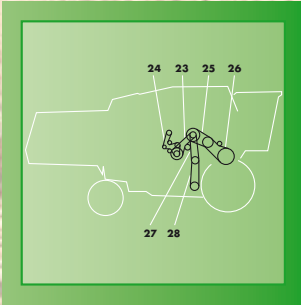

No.	Application	OEM - PN	Set	Optibelt AP-Nr.	EAN
1		Z55801	1	1000786	4014486472028
1		Z54406	1	1001122	4014486497083
1		Z61151	1	1001761	4014486487442
2		Z58752	1	1000788	4014486472042
2		Z59419	1	1001125	4014486497113
3		Z59556	1	1000635	4014486469899
3		Z63005	1	1000648	4014486470093
4		Z59557	1	1001388	4014486475043
5		Z44936	1	1001542	4014486460612
6		Z61858	1	1001973	4014486490886
7		Z62110	1	1001423	4014486459302
8		Z62111	1	1001432	4014486459401
11		Z59344	1	1003858	4014486519907
13		Z64912	1	1001751	4014486519525
13		Z61150	1	1001754	4014486519532
13		Z52909	1	1003856	4014486496680
14		Z61857	1	1001190	4014486520422
15		Z59286	1	1001911	4014486489736
16		Z59114	1	1000324	4014486465488
17		Z59342	1	1003622	4014486487114
18		Z60135	1	1000395	4014486466584
19		Z59322	1	1000640	4014486469981

JOHN DEERE 2058

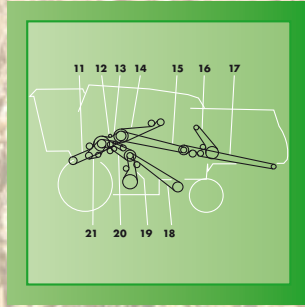
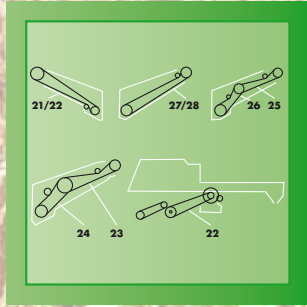
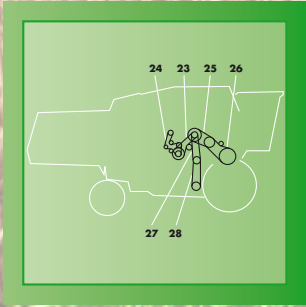

20		Z56959	1	1001089	4014486496710
21		Z56421	1	1001084	4014486496666
22		Z48212	1	1001769	4014486519600
23		Z61152	1	1001764	4014486487473
23		Z60931	1	1003623	4014486487503
24		Z61154	1	1001448	4014486459562
24		Z62211	1	1001449	4014486459579
25		Z54807	1	1001096	4014486496789
25		Z61152	1	1001764	4014486487473
25		Z60931	1	1003623	4014486487503
25		Z58751	1	1004084	4014486520453
26		Z55459	1	1001085	4014486496673
26		Z61153	1	1001753	4014486487367
26		Z61827	1	1001755	4014486519549
26		Z62213	1	1003856	4014486496680
27		Z54406	1	1001122	4014486497083
27		Z62214	1	1001127	4014486497137
27		Z62551	1	1001784	4014486519655
28		Z60930	1	1001784	4014486519655
28		Z62552	1	1001786	4014486519679

JOHN DEERE 2064

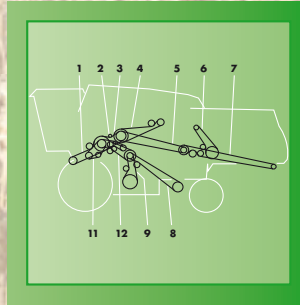
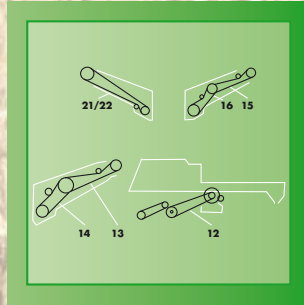
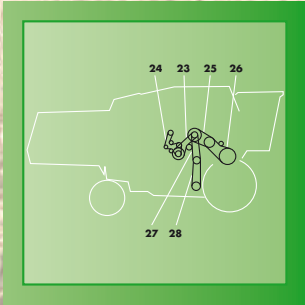

No.	Application	OEM - PN	Set	Optibelt AP-Nr.	EAN
1		Z61151	1	1001761	4014486487442
1		Z59344	1	1003858	4014486519907
3		Z64912	1	1001751	4014486519525
3		Z61150	1	1001754	4014486519532
3		Z52909	1	1003856	4014486496680
4		Z61857	1	1001190	4014486520422
5		Z59286	1	1001911	4014486489736
6		Z59114	1	1000324	4014486465488
7		Z59342	1	1003622	4014486487114
8		Z60135	1	1000395	4014486466584
9		Z56421	1	1001084	4014486496666
10		Z56959	1	1001089	4014486496710
11		Z59322	1	1000640	4014486469981
12		Z59419	1	1001125	4014486497113
12		Z48212	1	1001769	4014486519600
13		Z61152	1	1001764	4014486487473
13		Z60931	1	1003623	4014486487503
14		Z61154	1	1001448	4014486459562
14		Z62211	1	1001449	4014486459579
15		Z54807	1	1001096	4014486496789
15		Z61152	1	1001764	4014486487473
15		Z60931	1	1003623	4014486487503

JOHN DEERE 2064

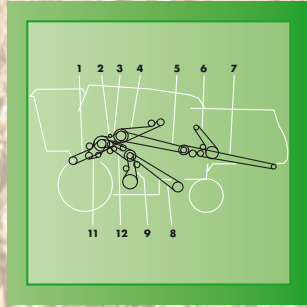
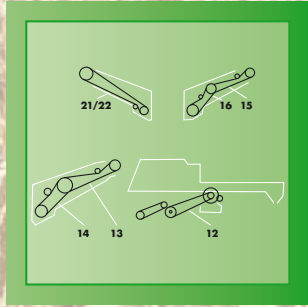
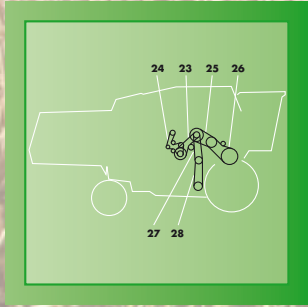

15		Z58751	1	1004084	4014486520453
16		Z55459	1	1001085	4014486496673
16		Z61153	1	1001753	4014486487367
16		Z61827	1	1001755	4014486519549
16		Z62213	1	1003856	4014486496680
21		Z55801	1	1000786	4014486472028
21		Z54406	1	1001122	4014486497083
22		Z58752	1	1000788	4014486472042
22		Z59419	1	1001125	4014486497113
23		Z59556	1	1000635	4014486469899
23		Z63005	1	1000648	4014486470093
24		Z59557	1	1001388	4014486475043
25		Z44936	1	1001542	4014486460612
26		Z61858	1	1001973	4014486490886
27		Z62110	1	1001423	4014486459302
28		Z62111	1	1001432	4014486459401

JOHN DEERE 2066

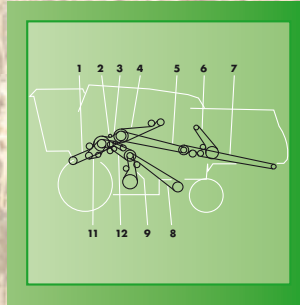
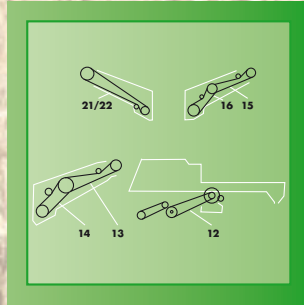
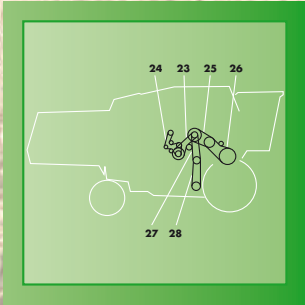

No.	Application	OEM - PN	Set	Optibelt AP-Nr.	EAN
1		Z61151	1	1001761	4014486487442
1		Z59344	1	1003858	4014486519907
3		Z64912	1	1001751	4014486519525
3		Z61150	1	1001754	4014486519532
3		Z52909	1	1003856	4014486496680
4		Z61857	1	1001190	4014486520422
5		Z59286	1	1001911	4014486489736
6		Z59114	1	1000324	4014486465488
7		Z59342	1	1003622	4014486487114
8		Z60135	1	1000395	4014486466584
9		Z56421	1	1001084	4014486496666
10		Z56959	1	1001089	4014486496710
11		Z59322	1	1000640	4014486469981
12		Z59419	1	1001125	4014486497113
12		Z48212	1	1001769	4014486519600
13		Z61152	1	1001764	4014486487473
13		Z60931	1	1003623	4014486487503
14		Z61154	1	1001448	4014486459562
14		Z62211	1	1001449	4014486459579
15		Z54807	1	1001096	4014486496789
15		Z61152	1	1001764	4014486487473
15		Z60931	1	1003623	4014486487503

JOHN DEERE 2066, 2250

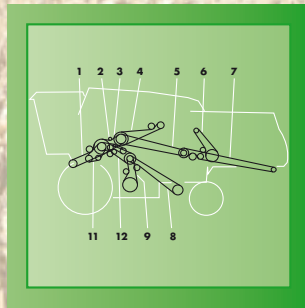
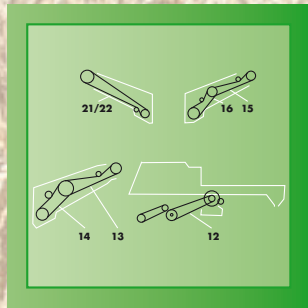
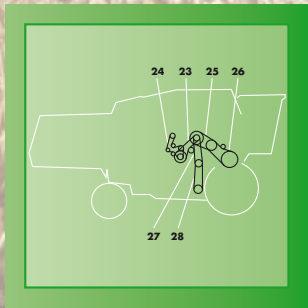

15		Z58751	1	1004084	4014486520453
16		Z55459	1	1001085	4014486496673
16		Z61153	1	1001753	4014486487367
16		Z61827	1	1001755	4014486519549
16		Z62213	1	1003856	4014486496680
21		Z55801	1	1000786	4014486472028
21		Z54406	1	1001122	4014486497083
22		Z58752	1	1000788	4014486472042
22		Z59419	1	1001125	4014486497113
23		Z59556	1	1000635	4014486469899
23		Z63005	1	1000648	4014486470093
24		Z59557	1	1001388	4014486475043
25		Z44936	1	1001542	4014486460612
26		Z61858	1	1001973	4014486490886
27		Z62110	1	1001423	4014486459302
28		Z62111	1	1001432	4014486459401
4	PLATFORM DRIVE	E58967	1	1004189	4014486558135

JOHN DEERE 2254

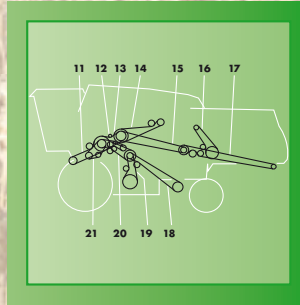
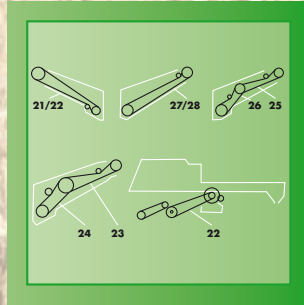
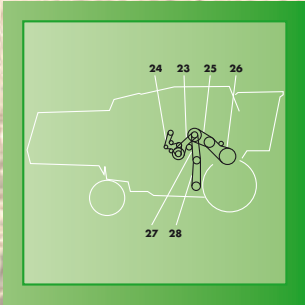

No.	Application	OEM - PN	Set	Optibelt AP-Nr.	EAN
1		Z61151	1	1001761	4014486487442
1		Z59344	1	1003858	4014486519907
3		Z64912	1	1001751	4014486519525
3		Z61150	1	1001754	4014486519532
4		Z61857	1	1001190	4014486520422
5		Z59286	1	1001911	4014486489736
6		Z59114	1	1000324	4014486465488
7		Z59342	1	1003622	4014486487114
8		Z60135	1	1000395	4014486466584
9		Z59322	1	1000640	4014486469981
10		Z56959	1	1001089	4014486496710
11		Z56421	1	1001084	4014486496666
12		Z48212	1	1001769	4014486519600
13		Z61152	1	1001764	4014486487473
13		Z60931	1	1003623	4014486487503
14		Z62211	1	1001449	4014486459579
15		Z54807	1	1001096	4014486496789
15		Z61152	1	1001764	4014486487473
15		Z60931	1	1003623	4014486487503
15		Z58751	1	1004084	4014486520453
16		Z61827	1	1001755	4014486519549
16		Z62213	1	1003856	4014486496680

JOHN DEERE 2254

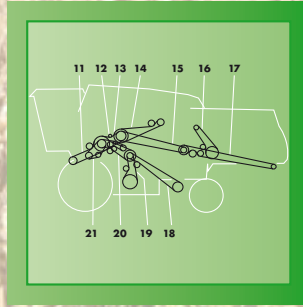
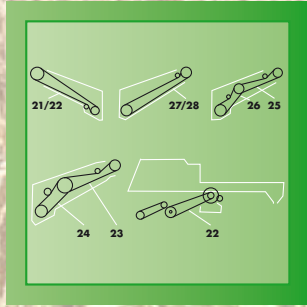
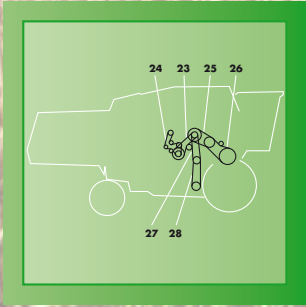

17		Z54406	1	1001122	4014486497083
17		Z62551	1	1001784	4014486519655
18		Z62214	1	1001127	4014486497137
18		Z62552	1	1001786	4014486519679
21		Z54406	1	1001122	4014486497083
22		Z59419	1	1001125	4014486497113
23		Z63005	1	1000648	4014486470093
24		Z59557	1	1001388	4014486475043
25		Z44936	1	1001542	4014486460612
26		Z61858	1	1001973	4014486490886
27		Z62110	1	1001423	4014486459302
28		Z62111	1	1001432	4014486459401

JOHN DEERE 2256

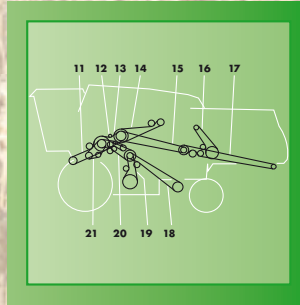
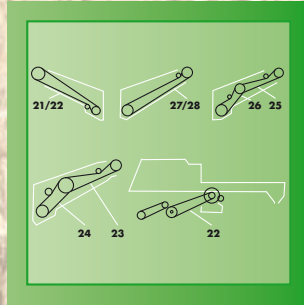
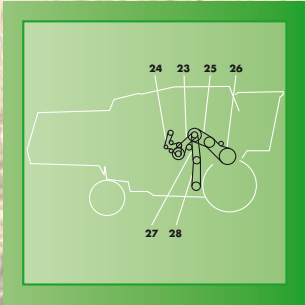

No.	Application	OEM - PN	Set	Optibelt AP-Nr.	EAN
1		Z61151	1	1001761	4014486487442
1		Z59344	1	1003858	4014486519907
3		Z64912	1	1001751	4014486519525
3		Z61150	1	1001754	4014486519532
4		Z61857	1	1001190	4014486520422
5		Z59286	1	1001911	4014486489736
6		Z59114	1	1000324	4014486465488
7		Z59342	1	1003622	4014486487114
8		Z60135	1	1000395	4014486466584
9		Z59322	1	1000640	4014486469981
10		Z56959	1	1001089	4014486496710
11		Z56421	1	1001084	4014486496666
12		Z48212	1	1001769	4014486519600
13		Z61152	1	1001764	4014486487473
13		Z60931	1	1003623	4014486487503
14		Z62211	1	1001449	4014486459579
15		Z54807	1	1001096	4014486496789
15		Z61152	1	1001764	4014486487473
15		Z60931	1	1003623	4014486487503
15		Z58751	1	1004084	4014486520453
16		Z61827	1	1001755	4014486519549
16		Z62213	1	1003856	4014486496680

JOHN DEERE 2256

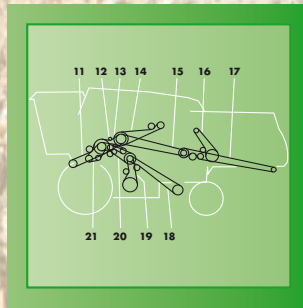
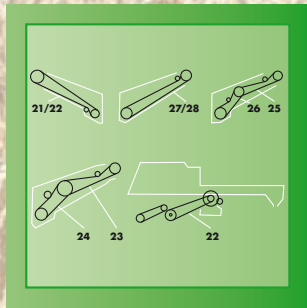
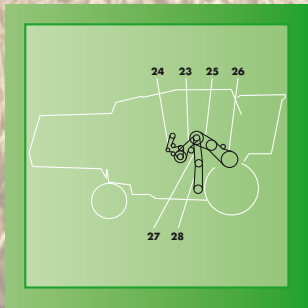

17		Z54406	1	1001122	4014486497083
17		Z62551	1	1001784	4014486519655
18		Z62214	1	1001127	4014486497137
18		Z62552	1	1001786	4014486519679
21		Z54406	1	1001122	4014486497083
22		Z59419	1	1001125	4014486497113
23		Z63005	1	1000648	4014486470093
24		Z59557	1	1001388	4014486475043
25		Z44936	1	1001542	4014486460612
26		Z61858	1	1001973	4014486490886
27		Z62110	1	1001423	4014486459302
28		Z62111	1	1001432	4014486459401

JOHN DEERE 2258

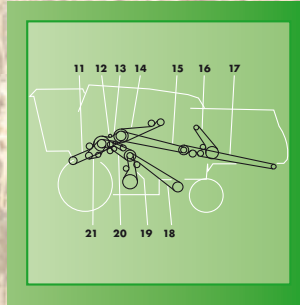
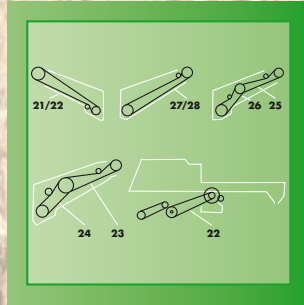
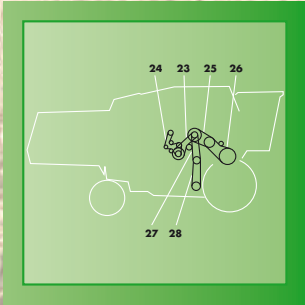

No.	Application	OEM - PN	Set	Optibelt AP-Nr.	EAN
1		Z61151	1	1001761	4014486487442
1		Z59344	1	1003858	4014486519907
3		Z64912	1	1001751	4014486519525
3		Z61150	1	1001754	4014486519532
4		Z61857	1	1001190	4014486520422
5		Z59286	1	1001911	4014486489736
6		Z59114	1	1000324	4014486465488
7		Z59342	1	1003622	4014486487114
8		Z60135	1	1000395	4014486466584
9		Z59322	1	1000640	4014486469981
10		Z56959	1	1001089	4014486496710
11		Z56421	1	1001084	4014486496666
12		Z48212	1	1001769	4014486519600
13		Z61152	1	1001764	4014486487473
13		Z60931	1	1003623	4014486487503
14		Z62211	1	1001449	4014486459579
15		Z54807	1	1001096	4014486496789
15		Z61152	1	1001764	4014486487473
15		Z60931	1	1003623	4014486487503
15		Z58751	1	1004084	4014486520453
16		Z61827	1	1001755	4014486519549
16		Z62213	1	1003856	4014486496680

JOHN DEERE 2258

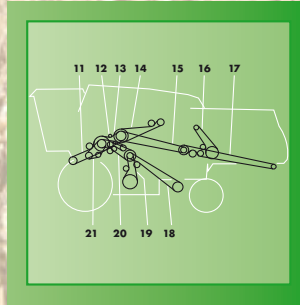
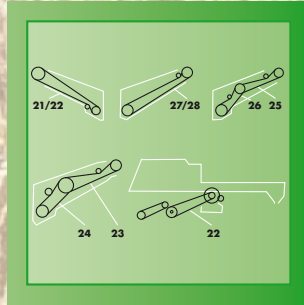
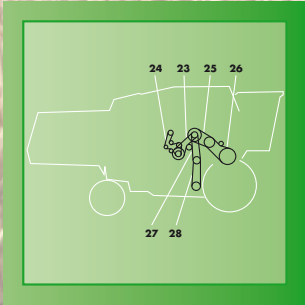

17		Z54406	1	1001122	4014486497083
17		Z62551	1	1001784	4014486519655
18		Z62214	1	1001127	4014486497137
18		Z62552	1	1001786	4014486519679
21		Z54406	1	1001122	4014486497083
22		Z59419	1	1001125	4014486497113
23		Z63005	1	1000648	4014486470093
24		Z59557	1	1001388	4014486475043
25		Z44936	1	1001542	4014486460612
26		Z61858	1	1001973	4014486490886
27		Z62110	1	1001423	4014486459302
28		Z62111	1	1001432	4014486459401

JOHN DEERE 2264

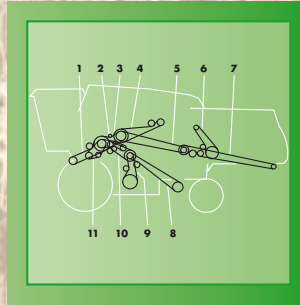
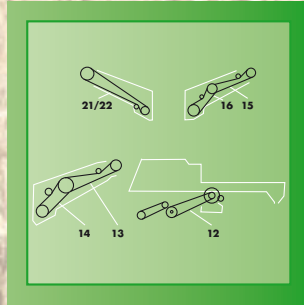
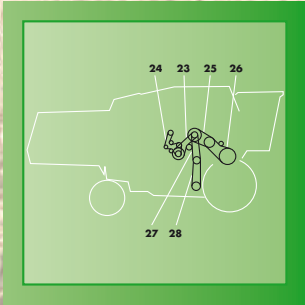

No.	Application	OEM - PN	Set	Optibelt AP-Nr.	EAN
1		Z61151	1	1001761	4014486487442
1		Z59344	1	1003858	4014486519907
3		Z64912	1	1001751	4014486519525
3		Z61150	1	1001754	4014486519532
4		Z61857	1	1001190	4014486520422
5		Z59286	1	1001911	4014486489736
6		Z59114	1	1000324	4014486465488
7		Z59342	1	1003622	4014486487114
8		Z60135	1	1000395	4014486466584
9		Z56421	1	1001084	4014486496666
10		Z56959	1	1001089	4014486496710
11		Z59322	1	1000640	4014486469981
12		Z48212	1	1001769	4014486519600
13		Z61152	1	1001764	4014486487473
13		Z60931	1	1003623	4014486487503
14		Z62211	1	1001449	4014486459579
15		Z54807	1	1001096	4014486496789
15		Z61152	1	1001764	4014486487473
15		Z60931	1	1003623	4014486487503
15		Z58751	1	1004084	4014486520453
16		Z61827	1	1001755	4014486519549
16		Z62213	1	1003856	4014486496680

JOHN DEERE 2264

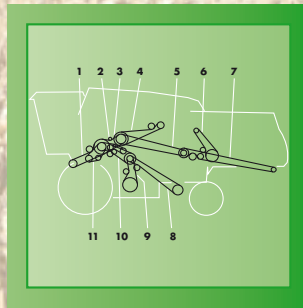
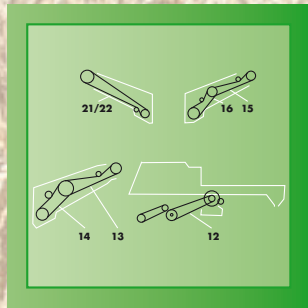
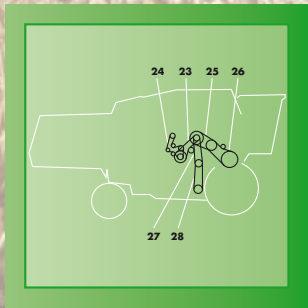

21		Z54406	1	1001122	4014486497083
22		Z59419	1	1001125	4014486497113
23		Z63005	1	1000648	4014486470093
24		Z59557	1	1001388	4014486475043
25		Z44936	1	1001542	4014486460612
26		Z61858	1	1001973	4014486490886
27		Z62110	1	1001423	4014486459302
28		Z62111	1	1001432	4014486459401

JOHN DEERE 2266

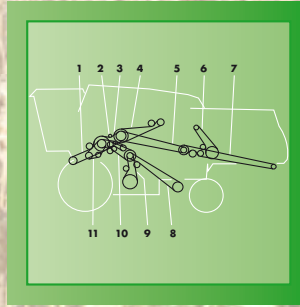
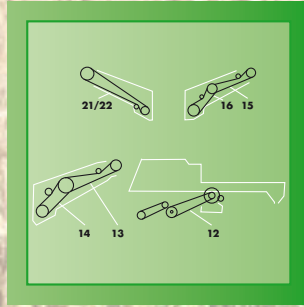
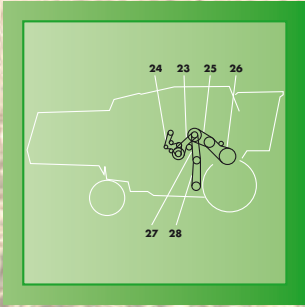

No.	Application	OEM - PN	Set	Optibelt AP-Nr.	EAN
1		Z61151	1	1001761	4014486487442
1		Z59344	1	1003858	4014486519907
3		Z64912	1	1001751	4014486519525
3		Z61150	1	1001754	4014486519532
4		Z61857	1	1001190	4014486520422
5		Z59286	1	1001911	4014486489736
6		Z59114	1	1000324	4014486465488
7		Z59342	1	1003622	4014486487114
8		Z60135	1	1000395	4014486466584
9		Z56421	1	1001084	4014486496666
10		Z56959	1	1001089	4014486496710
11		Z59322	1	1000640	4014486469981
12		Z48212	1	1001769	4014486519600
13		Z61152	1	1001764	4014486487473
13		Z60931	1	1003623	4014486487503
14		Z62211	1	1001449	4014486459579
15		Z54807	1	1001096	4014486496789
15		Z61152	1	1001764	4014486487473
15		Z60931	1	1003623	4014486487503
15		Z58751	1	1004084	4014486520453
16		Z61827	1	1001755	4014486519549
16		Z62213	1	1003856	4014486496680

JOHN DEERE 2266, 2270, 2280, 3300, 3430

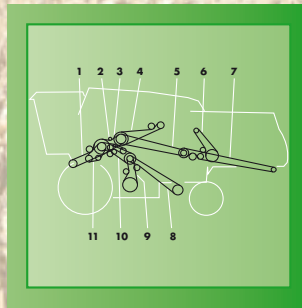
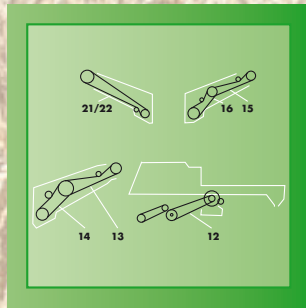
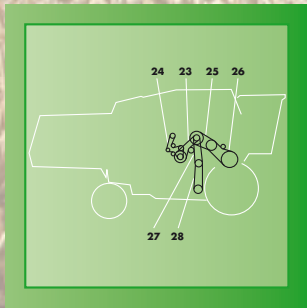

21		Z54406	1	1001122	4014486497083
22		Z59419	1	1001125	4014486497113
23		Z63005	1	1000648	4014486470093
24		Z59557	1	1001388	4014486475043
25		Z44936	1	1001542	4014486460612
26		Z61858	1	1001973	4014486490886
27		Z62110	1	1001423	4014486459302
28		Z62111	1	1001432	4014486459401
4	PLATFORM DRIVE	E58967	1	1004189	4014486558135
4	PLATFORM DRIVE	E58967	1	1004189	4014486558135
7	AIR CONDITIONING COMPRESSOR DRIVE 292	H80896	1	1002570	4014486495355
24	COUNTERSHAFT (SECONDARY)	H138762	1	1000710	4014486470987
28	UNLOADING AUGER COUNTERSHAFT	H76136	1	1000542	4014486468243
3	WATERPUMP DRIVE	R73784	1	1003983	4014486519273

JOHN DEERE 4400, 4420

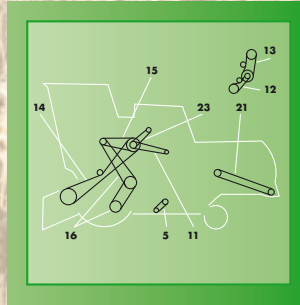
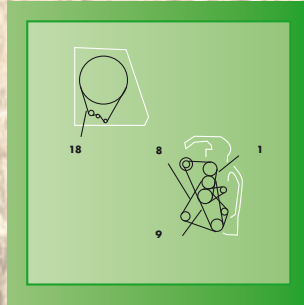
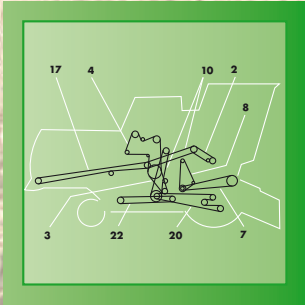

No.	Application	OEM - PN	Set	Optibelt AP-Nr.	EAN
1	ALTERNATOR AND WATERPUMP DRIVE 329DH-02	H80896	1	1002570	4014486495355
7	COMPRESSOR DRIVE (GAS ENGINE) AC 292	H80896	1	1002570	4014486495355
8	COMPRESSOR DRIVE (DIESEL ENGINE) AC 292	H80896	1	1002570	4014486495355
19	PROPULSION DRIVE (LOWER)	H76136	1	1000542	4014486468243
23	COUNTERSHAFT (SECONDARY)	H138762	1	1000710	4014486470987
28	UNLOADING AUGER COUNTERSHAFT	H76136	1	1000542	4014486468243
8	UNLOADING AUGER COUNTERSHAFT	H76136	1	1000542	4014486468243
14	STRAW SPREADER DRIVE	Z33774	1	1000401	4014486466645
15	BEATER DRIVE	Z33790	1	1001995	4014486491180
16	FEEDER HOUSE DRIVE	Z38186	1	1001647	4014486485998
17	STRAW CHOPPER (FRONT)	Z44761	1	1001668	4014486486315
24	COUNTERSHAFT (SECONDARY)	H138762	1	1000710	4014486470987

JOHN DEERE 4425, 4700



BISO - Schrattecker
BIZON
CASE INTL. HARVESTER
CLAAS
DEUTZ-FAHR
DRONNING-BORG
FENDT
FORTSCHRITT
JOHN DEERE
KRONE
LAVERDA
MASSEY FERGUSON
ROSTSELMASH
NEW HOLLAND

No.	Application	OEM - PN	Set	Optibelt AP-Nr.	EAN
1	ALTERNATOR, WATER PUMP	AR72036	1	1002351	4014486478846
2	BEATER	Z33790	1	1001995	4014486491180
3	CLEANING FAN	Z41178	1	1001396	4014486459012
4	COMPRESSOR	Z42756	1	1002350	4014486478839
5	CONDENSER FAN	Z45482	1	1003400	4014486462906
6	CONDENSER ROTARY BLADE	Z43863	1	1000036	4014486460735
7	CONDENSER ROTARY BLADE	Z38704	1	1000039	4014486460766
8	COUNTERSHAFT TO ROTARY SCREEN	Z34786	1	1000040	4014486460773
9	CRANKSHAFT TO COUNTERSHAFT	Z32190	1	1000002	4014486458985
11	FEEDER HOUSE	Z38186	1	1001647	4014486485998
12	LOWER GROUND DRIVE	Z34099	1	1001523	4014486460421
13	MAIN HYDRAULIC PUMP	Z34828	1	1003397	4014486462821
14	SEPARATOR	Z34405	1	1000675	4014486470475
15	STRAW CHOPPER, FRONT	Z44761	1	1001668	4014486486315
17	STRAW SPREADER	Z33774	1	1000401	4014486466645
18	TAILINGS ELEVATOR	Z45026	1	1000261	4014486464177
19	UNLOADING AUGER	Z47911	1	1000604	4014486469363
20	UPPER GROUND DRIVE (PKG. 2)	AZ35635	2	1001105	4014486496871
1		R500173	1	1003213	4014486482348

JOHN DEERE 6600, 6602, 6610

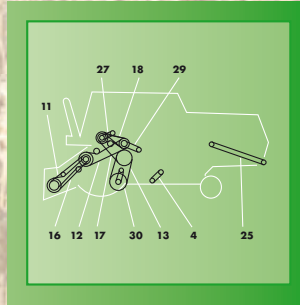
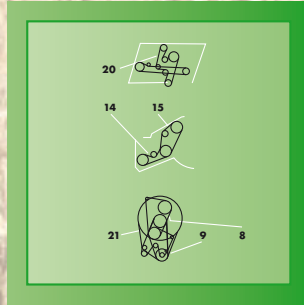
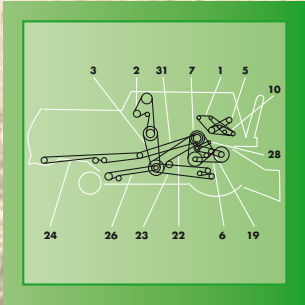

No.	Application	OEM - PN	Set	Optibelt AP-Nr.	EAN
2	U-JOINT LOADING AUGER	H23950	1	1000682	4014486470581
3	CLEAN GRAIN ELEVATOR COUNTERSHAFT	H27433	1	1000598	4014486469301
5	AIR CONDITIONING COMPRESSOR DRIVE	H80896	1	1002570	4014486495355
7	CYLINDER - INTERMEDIATE SHAFT	H113749	1	1001514	4014486460339
11	FEEDER CONVEYOR (LONG FEEDER HOUSE)	H125380	1	1000791	4014486472073
13	HYDROSTATIC PROPULSION DRIVE (LOWER)	AH84633	1	1001087	4014486496697
17	HYDROSTATIC PROPULSION DRIVE (UPPER)	AH84633	1	1001087	4014486496697
26	TAILINGS AUGER (LOWER)	N110085	1	1000702	4014486470857
31	STRAW CHOPPER DRIVE	H80103	1	1000709	4014486470970
8	ELEVATOR DRIVE GRAIN	H23950	1	1000682	4014486470581
17		H80103	1	1000709	4014486470970
18	ELEVATOR DRIVE GRAIN	H27433	1	1000598	4014486469301
19	AUGER DRIVE	N110085	1	1000702	4014486470857
1		Z48567	1	1002618	4014486498028
2		AZ39678	1	1001110	4014486496932
3		AZ39676	2	1002766	4014486464306
4		AZ39677	3	1001343	4014486474558

JOHN DEERE 6620, 6622, 6650, 6700, 6710

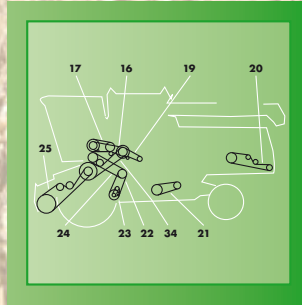
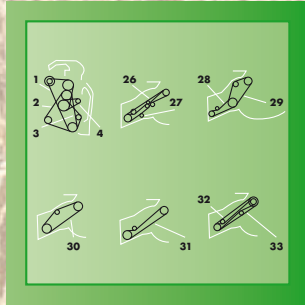
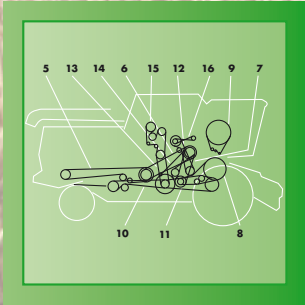

No.	Application	OEM - PN	Set	Optibelt AP-Nr.	EAN
	TORQUE-SENSING COUNTERSHAFT DRIVE	H113749	1	1001514	4014486460339
13	CLEAN GRAIN ELEVATOR COUNTERSHAFT	H27433	1	1000598	4014486469301
18	MULTI-GROOVE SEPARATOR DRIVE	H108175	1	1001140	4014486490022
22	GROUND DRIVE (LOWER)	AH84633	1	1001087	4014486496697
24	GROUND DRIVE (UPPER)	AH84633	1	1001087	4014486496697
26	FEEDER CONVEYOR DRIVE (SERIAL NR. ... - 403301)	H125380	1	1000791	4014486472073
31	FEEDER HOUSE - LOWER FIXED LESS REVERSER (SERIAL NR 615100 - ...)	Z30130	1	1001111	4014486496949
5	LEFT-HAND SIDE	H136881	1	1000693	4014486470741
7	TORQUE-SENSING COUNTERSHAFT DRIVE	H113749	1	1001514	4014486460339
9	CLEAN GRAIN ELEVATOR AND LOADING	H23950	1	1000682	4014486470581
10	CLEAN GRAIN ELEVATOR COUNTERSHAFT	H27433	1	1000598	4014486469301
12	CLEAN GRAIN ELEVATOR COUNTERSHAFT	H27433	1	1000598	4014486469301
25	MULTI-GROOVE SEPARATOR DRIVE	H108175	1	1001140	4014486490022
1		R136235	1	1002684	4014486482591
1		R135199	1	1003235	4014486482669
2		Z55771	1	1002360	4014486478945

JOHN DEERE 6750, 6810, 6950, 7700

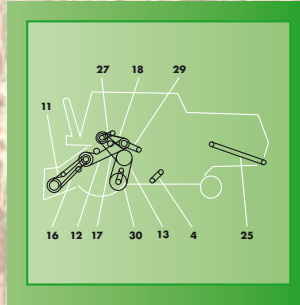
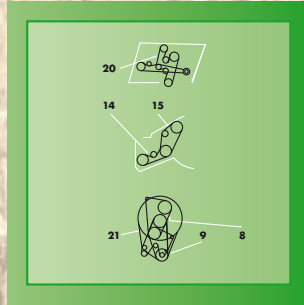
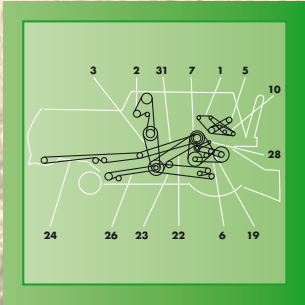

No.	Application	OEM - PN	Set	Optibelt AP-Nr.	EAN
1		R503312	1	1002614	4014486484182
2		R502599	1	1002651	4014486481143
1		AZ51312	2	1003982	4014486519808
2		Z58886	1	1003711	4014486494662
3		AZ56225	2	1002313	4014486480016
1		AZ51638	1	1004153	4014486523676
1	ALTERNATOR AND WATERPUMP DRIVE (GAS ENGINE)	H80896	1	1002570	4014486495355
2	CLEAN GRAIN ELEVATOR U-JOINT LOADING AUGER	H23950	1	1000682	4014486470581
3	CLEAN GRAIN ELEVATOR COUNTERSHAFT	H27433	1	1000598	4014486469301
5	AIR CONDITIONING COMPRESSOR DRIVE 404TH-01	H80896	1	1002570	4014486495355
7	CYLINDER - INTERMEDIATE SHAFT	H113749	1	1001514	4014486460339
11	FEEDER CONVEYOR (LONG FEEDER HOUSE)	H125380	1	1000791	4014486472073
13	HYDROSTATIC PROPULSION DRIVE (LOWER)	AH84633	1	1001087	4014486496697
17	HYDROSTATIC PROPULSION DRIVE (UPPER)	AH84633	1	1001087	4014486496697
18	COUNTERSHAFT (PRIMARY) 404TH-01	H108175	1	1001140	4014486490022
26	TAILINGS AUGER (LOWER)	N110085	1	1000702	4014486470857
31	STRAW CHOPPER DRIVE	H80103	1	1000709	4014486470970

JOHN DEERE 7720, 7721, 7722

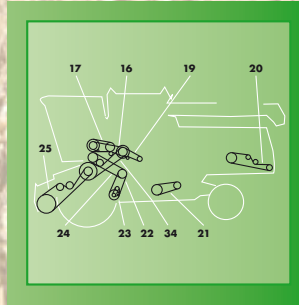
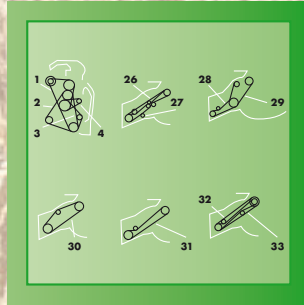
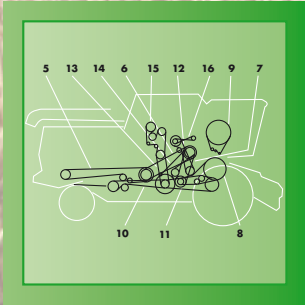

No.	Application	OEM - PN	Set	Optibelt AP-Nr.	EAN
10	TORQUE-SENSING COUNTERSHAFT DRIVE	H113749	1	1001514	4014486460339
13	CLEAN GRAIN ELEVATOR COUNTERSHAFT	H27433	1	1000598	4014486469301
19	FEEDER CONVEYOR DRIVE	H125380	1	1000791	4014486472073
27	MULTI-GROOVE SEPARATOR DRIVE	H108175	1	1001140	4014486490022
29	DRIVE (LOWER)	Z30130	1	1001111	4014486496949
36	GROUND DRIVE (UPPER)	AH84633	1	1001087	4014486496697
38	GROUND DRIVE (LOWER)	AH84633	1	1001087	4014486496697
4	CLEAN GRAIN ELEVATOR COUNTERSHAFT	H27433	1	1000598	4014486469301
14	UNLOADING AUGER COUNTERSHAFT	H23950	1	1000682	4014486470581
5	GROUND DRIVE (UPPER)	AH84633	1	1001087	4014486496697
9	ENGINE POWERSHAFT	AH84633	1	1001087	4014486496697
10	ENGINE POWERSHAFT	H108175	1	1001140	4014486490022
15	CUTTERBAR DRIVE (HILLSIDE)	H21925	1	1000694	4014486470734

JOHN DEERE 8820

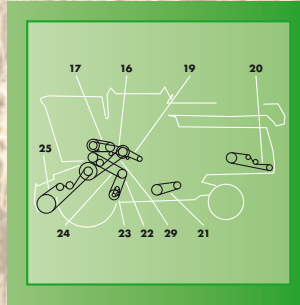
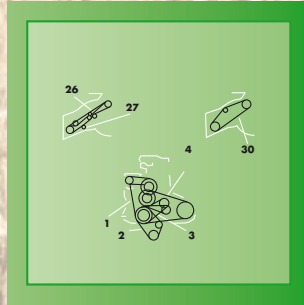
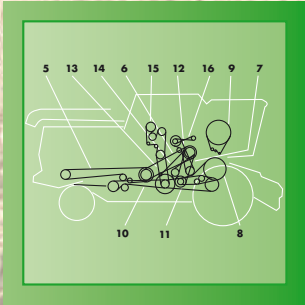

No.	Application	OEM - PN	Set	Optibelt AP-Nr.	EAN
8	TORQUE-SENSING COUNTERSHAFT DRIVE	H113749	1	1001514	4014486460339
11	CLEAN GRAIN ELEVATOR COUNTERSHAFT	H27433	1	1000598	4014486469301
17	FEEDER CONVEYOR DRIVE	H125380	1	1000791	4014486472073
22	MULTI-GROOVE SEPARATOR DRIVE	H108175	1	1001140	4014486490022
29	GROUND DRIVE (UPPER)	AH84633	1	1001087	4014486496697
31	GROUND DRIVE (LOWER)	AH84633	1	1001087	4014486496697

JOHN DEERE 9400

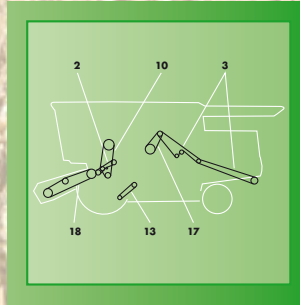
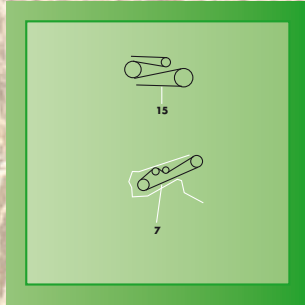
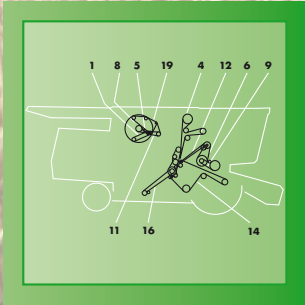

No.	Application	OEM - PN	Set	Optibelt AP-Nr.	EAN
6	CYLINDER DRIVE INTERMEDIATE	H115759	1	1001543	4014486460636
6	CLEAN GRAIN ELEVATOR DRIVE	H141167	1	1004088	4014486520088
7	CYLINDER DRIVE REGULAR DUAL RANGE	H115881	1	1003663	4014486490817
8	TAILINGS AUGER AND ELEVATOR (LOWER)	N110085	1	1000702	4014486470857
10	COUNTERSHAFT (SECONDARY)	H128010	1	1000797	4014486472165
11	STRAW WALKER SHOE - CONVEYOR AUGERS	H131169	1	1001392	4014486475104
12	UNLOADING SYSTEM	AH127866	2	1003765	4014486469394
13	STRAW CHOPPER DRIVE, FRONT	H125380	1	1000791	4014486472073
14	REGULAR	H140404	1	1001434	4014486459425
15	HEADER AND REEL PUMP	H140160	1	1003570	4014486497014
16	FEEDER DRIVE VARIABLE SPEED	H125711	1	1001453	4014486459616
17	BEATER (100 PERCENT BEATER SPEED)	AH139436	2	1001382	4014486474978
18	FEEDER HOUSE FIXED SPEED WITH REVERSER	H126345	1	1001124	4014486497106
19	STRAW SPREADER DRIVE	Z33774	1	1000401	4014486466645

JOHN DEERE 9410



No.	Application	OEM - PN	Set	Optibelt AP-Nr.	EAN
1	AIR CONDITIONING COMPRESSOR	H80896	1	1002570	4014486495355
4	BEATER DRIVE (75 PERCENT)	AH163931	2	1001381	4014486474961
5	BEATER DRIVE (100 PERCENT)	AH139436	2	1001382	4014486474978
6	CHOPPER IN WINDROW OR FORWARD POSITION	H27433	1	1000598	4014486469301
11	CYLINDER DR. REGULAR DUAL RANGE & SINGLE RANGE	H115881	1	1003663	4014486490817
15	FIXED SPEED FEEDER HOUSE WITH REVERSER	H126345	1	1001124	4014486497106
19	LOWER TAILINGS AUGER & ELEVATOR	N110085	1	1000702	4014486470857
22	SECONDARY COUNTERSHAFT	H128010	1	1000797	4014486472165
23	SHOE, STRAW WALKER & CONVEYOR AUGERS	H131169	1	1001392	4014486475104
24	STRAW CHOPPER DRIVE, FRONT	H125380	1	1000791	4014486472073
25	STRAW CHOPPER DRIVE, REGULAR	H140404	1	1001434	4014486459425
27	STRAW SPREADER	Z33774	1	1000401	4014486466645
28	UNLOADING SYSTEM	AH158880	2	1002861	4014486469400

JOHN DEERE 9450



No.	Application	OEM - PN	Set	Optibelt AP-Nr.	EAN
3	ALTERNATOR (95 AMP)	H163515	1	1003209	4014486482256
4	ALTERNATOR (185 AMP)	H166870	1	1004090	4014486520521
5	BEATER DRIVE (75%)	AH163931	2	1001381	4014486474961
6	BEATER DRIVE (100%)	AH139436	2	1001382	4014486474978
7	CLEAN GRAIN ELEVATOR	H141166	1	1001394	4014486475128
8	CLEANING FAN (750 - 1350 RPM)	H152146	1	1001435	4014486459432
9	CLEANING FAN (490 - 980 RPM)	H152180	1	1001431	4014486459395
11	COUNTERSHAFT SECONDARY	H128010	1	1000797	4014486472165
12	CYLINDER DRIVE (240 - 960 RPM) (STANDARD)	H115881	1	1003663	4014486490817
19	FIXED SPEED FEEDER HOUSE W/REVERSER (-700100)	H126345	1	1001124	4014486497106
22	LOWER TAILINGS AUGER & ELEVATOR	N110085	1	1000702	4014486470857
26	SHOE, WALKER, AND CONVEY OR AUGERS	H131169	1	1001392	4014486475104
29	STRAW CHOPPER (SHORT REAR)	H27433	1	1000598	4014486469301
30	STRAW SPREADER	Z33774	1	1000401	4014486466645
31	UNLOADING SYSTEM	AH158880	2	1002861	4014486469400

JOHN DEERE 9500

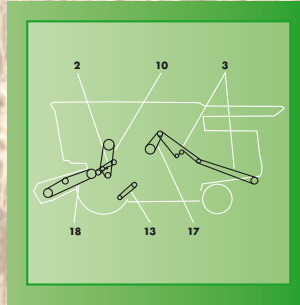
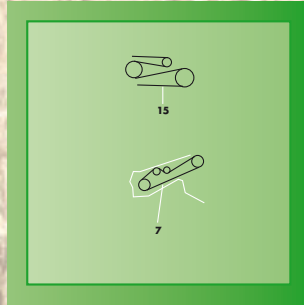
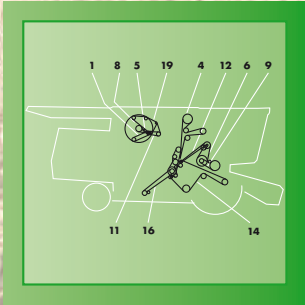

No.	Application	OEM - PN	Set	Optibelt AP-Nr.	EAN
5	CLEAN GRAIN ELEVATOR DRIVE	H141167	1	1004088	4014486520088
6	CYLINDER DRIVE INTERMEDIATE	H115759	1	1001543	4014486460636
7	CYLINDER DRIVE REGULAR DUAL RANGE	H115881	1	1003663	4014486490817
8	TAILINGS AUGER AND ELEVATOR (LOWER)	N110085	1	1000702	4014486470857
10	COUNTERSHAFT (SECONDARY)	H128010	1	1000797	4014486472165
11	STRAW WALKER SHOE - CONVEYOR AUGERS	H131169	1	1001392	4014486475104
12	UNLOADING SYSTEM	AH127866	2	1003765	4014486469394
13	LONG REAR	H125381	1	1000778	4014486471885
13	(FRONT)	H125380	1	1000791	4014486472073
14	REGULAR	H140404	1	1001434	4014486459425
15	HEADER AND REEL PUMP	H140160	1	1003570	4014486497014
16	FEEDER DRIVE VARIABLE SPEED	H125711	1	1001453	4014486459616
17	BEATER (100 PERCENT BEATER SPEED)	AH139436	2	1001382	4014486474978
18	FEEDER HOUSE FIXED SPEED WITH REVERSER	H126345	1	1001124	4014486497106
19	STRAW SPREADER DRIVE	H128234	1	1000419	4014486466829

JOHN DEERE 9501



No.	Application	OEM - PN	Set	Optibelt AP-Nr.	EAN
3	CYLINDER DR. REGULAR DUAL RANGE & SINGLE RANGE	H115881	1	1003663	4014486490817
5	FIXED SPEED FEEDER HOUSE WITH REVERSER	H126345	1	1001124	4014486497106
6	LOWER TAILINGS AUGER & ELEVATOR	N110085	1	1000702	4014486470857
8	SECONDARY COUNTERSHAFT	H128010	1	1000797	4014486472165
8	REGULAR (100 PERCENT)	AH139436	2	1001382	4014486474978
9	STRAW CHOPPER DRIVE, FRONT	H125380	1	1000791	4014486472073
9	SHOE, STRAW WALKER & CONVEYOR AUGERS	H131169	1	1001392	4014486475104
10	STRAW CHOPPER DRIVE, LONG REAR	H125381	1	1000778	4014486471885
11	STRAW CHOPPER DRIVE, REGULAR	H140404	1	1001434	4014486459425
14	STRAW SPREADER	H128234	1	1000419	4014486466829
16	UNLOADING SYSTEM	AH158880	2	1002861	4014486469400

JOHN DEERE 9510



No.	Application	OEM - PN	Set	Optibelt AP-Nr.	EAN
1	AIR CONDITIONING COMPRESSOR	H80896	1	1002570	4014486495355
4	BEATER DRIVE (75 PERCENT)	AH163931	2	1001381	4014486474961
4	BEATER DRIVE (100 PERCENT)	AH139436	2	1001382	4014486474978
5	CHOPPER IN WINDROW OR FORWARD POSITION	H23950	1	1000682	4014486470581
5	CHOPPER IN REAR (OPERATING) POSITION	H125381	1	1000778	4014486471885
8	CYLINDER DR. REGULAR DUAL RANGE & SINGLE RANGE	H115881	1	1003663	4014486490817
11	FIXED SPEED FEEDER HOUSE WITH REVERSER	H126345	1	1001124	4014486497106
12	LOWER TAILINGS AUGER & ELEVATOR	N110085	1	1000702	4014486470857
15	SECONDARY COUNTERSHAFT	H128010	1	1000797	4014486472165
16	SHOE, STRAW WALKER & CONVEYOR AUGERS	H131169	1	1001392	4014486475104
17	STRAW CHOPPER DRIVE, FRONT	H125380	1	1000791	4014486472073
17	STRAW CHOPPER DRIVE, REGULAR (750 - 1350 RPM)	H140404	1	1001434	4014486459425
18	STRAW SPREADER	H128234	1	1000419	4014486466829
19	UNLOADING SYSTEM	AH158880	2	1002861	4014486469400

JOHN DEERE 9540



No.	Application	OEM - PN	Set	Optibelt AP-Nr.	EAN
2		H115881	1	1003663	4014486490817
3		H177263	1	1001394	4014486475128
4		N110085	1	1000702	4014486470857
6	9540	H177589	1	1002285	4014486479683
7	9540	H175467	1	1003125	4014486480788
8		H176765	1	1001789	4014486519686
10		H177177	1	1001905	4014486489668
11		H152146	1	1001435	4014486459432
12		H176766	1	1001756	4014486519556
13	FOR HILLMASTER ONLY	H202821	1	1001759	4014486519563
16		AH139436	2	1001382	4014486474978
17		AH158880	2	1002861	4014486469400

JOHN DEERE 9550



No.	Application	OEM - PN	Set	Optibelt AP-Nr.	EAN
1	AIR CONDITIONING COMPRESSOR	H163515	1	1003209	4014486482256
3	ALTERNATOR (95 AMP)	H163515	1	1003209	4014486482256
3	ALTERNATOR (185 AMP)	H166870	1	1004090	4014486520521
4	BEATER DRIVE (75%)	AH163931	2	1001381	4014486474961
4	BEATER DRIVE (100%)	AH139436	2	1001382	4014486474978
5	CLEAN GRAIN ELEVATOR	H141166	1	1001394	4014486475128
6	CLEANING FAN (490 - 980 RPM)	H152180	1	1001431	4014486459395
6	CLEANING FAN (750 - 1350 RPM)	H152146	1	1001435	4014486459432
8	COUNTERSHAFT SECONDARY	H128010	1	1000797	4014486472165
10	CYLINDER DRIVE (240 - 960 RPM)	H115881	1	1003663	4014486490817
14	FIXED SPEED FEEDER HOUSE W/REVERSER (-700200)	H126345	1	1001124	4014486497106
16	LOWER TAILINGS AUGER & ELEVATOR	N110085	1	1000702	4014486470857
19	SHOE, WALKER, AND CONVEY OR AUGERS	H131169	1	1001392	4014486475104
20	STRAW CHOPPER (STANDARD BALING)	H23950	1	1000682	4014486470581
21	STRAW SPREADER	H128234	1	1000419	4014486466829
22	UNLOADING SYSTEM	AH158880	2	1002861	4014486469400

JOHN DEERE 9560



No.	Application	OEM - PN	Set	Optibelt AP-Nr.	EAN
2		H115881	1	1003663	4014486490817
3		H177263	1	1001394	4014486475128
4		N110085	1	1000702	4014486470857
7	9560 / 9580	H177186	1	1003223	4014486482508
8		H176765	1	1001789	4014486519686
10		H177177	1	1001905	4014486489668
11		H152146	1	1001435	4014486459432
12		H176766	1	1001756	4014486519556
13	FOR HILLMASTER ONLY	H202821	1	1001759	4014486519563
16		AH139436	2	1001382	4014486474978
17		AH158880	2	1002861	4014486469400

JOHN DEERE 9580



No.	Application	OEM - PN	Set	Optibelt AP-Nr.	EAN
2		H115881	1	1003663	4014486490817
3		H177263	1	1001394	4014486475128
4		N110085	1	1000702	4014486470857
7	9560 / 9580	H177186	1	1003223	4014486482508
8		H176765	1	1001789	4014486519686
10		H177177	1	1001905	4014486489668
11		H152146	1	1001435	4014486459432
12		H176766	1	1001756	4014486519556
13	FOR HILLMASTER ONLY	H202821	1	1001759	4014486519563
16		AH139436	2	1001382	4014486474978
17		AH158880	2	1002861	4014486469400

JOHN DEERE 9600

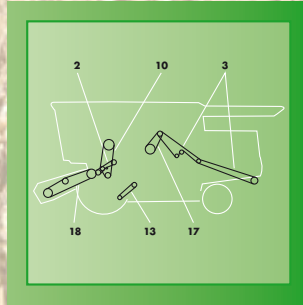
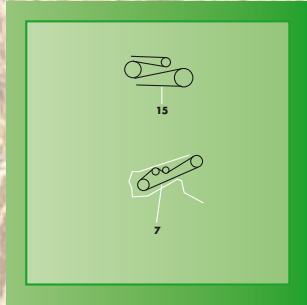
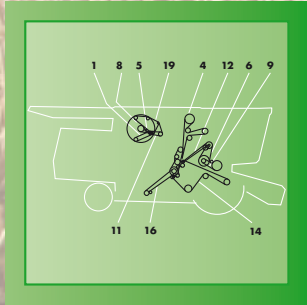

No.	Application	OEM - PN	Set	Optibelt AP-Nr.	EAN
5	CLEAN GRAIN ELEVATOR DRIVE	H141166	1	1001394	4014486475128
6	CYLINDER DRIVE INTERMEDIATE	H115759	1	1001543	4014486460636
7	CYLINDER DRIVE REGULAR DUAL RANGE	H115881	1	1003663	4014486490817
7	UNLOADING SYSTEM	AH127866	2	1003765	4014486469394
8	TAILINGS AUGER AND ELEVATOR (LOWER)	N110085	1	1000702	4014486470857
10	COUNTERSHAFT (SECONDARY)	H128010	1	1000797	4014486472165
11	STRAW WALKER SHOE - CONVEYOR AUGERS	H131169	1	1001392	4014486475104
12	UNLOADING SYSTEM	AH127866	2	1003765	4014486469394
13	LONG REAR	H125381	1	1000778	4014486471885
13	STRAW CHOPPER DRIVE, FRONT	H125380	1	1000791	4014486472073
14	REGULAR	H140404	1	1001434	4014486459425
15	HEADER AND REEL PUMP	H140160	1	1003570	4014486497014
16	FEEDER DRIVE VARIABLE SPEED	H125711	1	1001453	4014486459616
17	BEATER (100 PERCENT BEATER SPEED)	AH139436	2	1001382	4014486474978
18	FEEDER HOUSE FIXED SPEED WITH REVERSER	H126345	1	1001124	4014486497106
19	STRAW SPREADER DRIVE	H128234	1	1000419	4014486466829

JOHN DEERE 9610

No.	Application	OEM - PN	Set	Optibelt AP-Nr.	EAN
1	AIR CONDITIONING COMPRESSOR	H163515	1	1003209	4014486482256
3	ALTERNATOR	H163515	1	1003209	4014486482256
4	BEATER DRIVE (75 PERCENT)	AH163931	2	1001381	4014486474961
4	BEATER DRIVE (100 PERCENT)	AH139436	2	1001382	4014486474978
5	CHOPPER IN WINDROW OR FORWARD POSITION	H23950	1	1000682	4014486470581
5	CHOPPER IN REAR (OPERATING) POSITION	H125381	1	1000778	4014486471885
6	CLEAN GRAIN ELEVATOR	H141167	1	1004088	4014486520088
7	COOLING FAN	H153297	1	1001551	4014486484502
8	CYLINDER DR. REGULAR DUAL RANGE & SINGLE RANGE	H115881	1	1003663	4014486490817
9	ENGINE FAN	H153297	1	1001551	4014486484502
11	FIXED SPEED FEEDER HOUSE WITH REVERSER	H126345	1	1001124	4014486497106
14	LOWER TAILINGS AUGER & ELEVATOR	N110085	1	1000702	4014486470857
16	SECONDARY COUNTERSHAFT	H128010	1	1000797	4014486472165
17	SHOE, STRAW WALKER & CONVEYOR AUGERS	H131169	1	1001392	4014486475104
18	STRAW CHOPPER DRIVE, FRONT	H125380	1	1000791	4014486472073
18	STRAW CHOPPER DRIVE, SLOW SPEED	H152180	1	1001431	4014486459395
18	STRAW CHOPPER DRIVE, REGULAR SPEED	H152146	1	1001435	4014486459432
19	STRAW SPREADER	H128234	1	1000419	4014486466829
20	UNLOADING SYSTEM	AH158880	2	1002861	4014486469400

JOHN DEERE 9640



No.	Application	OEM - PN	Set	Optibelt AP-Nr.	EAN
2		H115881	1	1003663	4014486490817
3		H177263	1	1001394	4014486475128
4		N110085	1	1000702	4014486470857
7	9640	H177186	1	1003223	4014486482508
8		H176765	1	1001789	4014486519686
10		H177177	1	1001905	4014486489668
11		H152146	1	1001435	4014486459432
12		H176766	1	1001756	4014486519556
13	FOR HILLMASTER ONLY	H202821	1	1001759	4014486519563
15		AH139436	2	1001382	4014486474978
16		AH158880	2	1002861	4014486469400

JOHN DEERE 9650

No.	Application	OEM - PN	Set	Optibelt AP-Nr.	EAN
1		R164820	1	1003114	4014486480641
1	AIR CONDITIONING COMPRESSOR	H163515	1	1003209	4014486482256
2	ALTERNATOR (185 AMP) (-695301-)	R164820	1	1003114	4014486480641
2	ALTERNATOR (95 AMP) (-695300)	H163515	1	1003209	4014486482256
2	ALTERNATOR (185 AMP) (-695300)	H166870	1	1004090	4014486520521
3	BEATER DRIVE (75%)	AH163931	2	1001381	4014486474961
3	BEATER DRIVE (100%)	AH139436	2	1001382	4014486474978
4	CLEAN GRAIN ELEVATOR	H141166	1	1001394	4014486475128
5	CLEANING FAN (490 - 980 RPM)	H152180	1	1001431	4014486459395
5	CLEANING FAN (750 - 1350 RPM)	H152146	1	1001435	4014486459432
6	COOLING FAN (-695300)	H153297	1	1001551	4014486484502
6	COOLING FAN (695301-)	H177186	1	1003223	4014486482508
7	COUNTERSHAFT SECONDARY	H128010	1	1000797	4014486472165
8	CYLINDER DRIVE (240 - 960 RPM)	H115881	1	1003663	4014486490817
12	FIXED SPEED FEEDER HOUSE W/REVERSER (-700300)	H126345	1	1001124	4014486497106
14	LOWER TAILINGS AUGER & ELEVATOR	N110085	1	1000702	4014486470857
16	SHOE, WALKER, AND CONVEY OR AUGERS	H131169	1	1001392	4014486475104
17	STRAW CHOPPER (STANDARD BALING)	H23950	1	1000682	4014486470581
18	STRAW SPREADER	H128234	1	1000419	4014486466829
19	UNLOADING SYSTEM	AH158880	2	1002861	4014486469400

JOHN DEERE 9660



No.	Application	OEM - PN	Set	Optibelt AP-Nr.	EAN
1	9660 / 9680	H175628	1	1000180	4014486462098
2		H115881	1	1003663	4014486490817
3		H177263	1	1001394	4014486475128
4		N110085	1	1000702	4014486470857
7	9660 / 9680	H174455	1	1003217	4014486482454
8		H176765	1	1001789	4014486519686
10		H177177	1	1001905	4014486489668
11		H152146	1	1001435	4014486459432
12		H176766	1	1001756	4014486519556
13	FOR HILLMASTER ONLY	H202821	1	1001759	4014486519563
15		AH139436	2	1001382	4014486474978
16		AH158880	2	1002861	4014486469400

JOHN DEERE 9680, 9880, 9935



No.	Application	OEM - PN	Set	Optibelt AP-Nr.	EAN
1	9660 / 9680	H175628	1	1000180	4014486462098
2		H115881	1	1003663	4014486490817
3		H177263	1	1001394	4014486475128
4		N110085	1	1000702	4014486470857
7	9660 / 9680	H174455	1	1003217	4014486482454
8		H176765	1	1001789	4014486519686
10		H177177	1	1001905	4014486489668
11		H152146	1	1001435	4014486459432
12		H176766	1	1001756	4014486519556
13	FOR HILLMASTER ONLY	H202821	1	1001759	4014486519563
15		AH139436	2	1001382	4014486474978
16		AH158880	2	1002861	4014486469400
5	STRAW CHOPPER DRIVE	H217352	1	1001772	4014486519617
1		R123465	1	1003221	4014486482485

JOHN DEERE 9980



No.	Application	OEM - PN	Set	Optibelt AP-Nr.	EAN
1	CLEAN GRAIN ELEVATOR DRIVE	H158512	1	1000853	4014486472844
2		H154723	1	1000738	4014486471335
3		AH150678	2	1002892	4014486470192
5	SHOE FAN AND CONVEYOR AUGERS	H175587	1	1004166	4014486523003
6	CLEANING FAN DRIVE	H165072	1	1001425	4014486459326
8		H154731	1	1000586	4014486469073
9		H175628	1	1000180	4014486462098
10		H178037	1	1002433	4014486493115
11		R135609	1	1003196	4014486481891
12	STRAW CHOPPER (REAR)	H156541	1	1001785	4014486519662
14		AH160080	2	1000681	4014486470550
16		H168301	1	1000708	4014486470956
19		H174885	1	1002641	4014486480597

JOHN DEERE 1072 - 1075 - 1075 HYDRO 4

No.	Application	OEM - PN	Set	Optibelt AP-Nr.	EAN
1	FAN DRIVE - 1075 (TO NR 44386)	AR72036	1	1002351	4014486478846
4	1072 (FROM NR. 39787) - 1075-1075 HY4 (FROM NR. 44387)	Z34786	1	1000040	4014486460773
4	ROTARY SCREEN - 1075 HY 4 (TO NR. 44386)	Z37192	1	1004106	4014486522815
5	ROTARY SCREEN 1072 - 1075	Z32190	1	1000002	4014486458985
5	ROTARY SCREEN - 1075 HY 4 (FROM NR. 44387)	Z45191	1	1000003	4014486458992
5	ROTARY SCREEN - 1075 HY 4 (TO NR. 44386)	Z37191	1	1004105	4014486522761
6	CYLINDER VARIATOR DRIVE (1072)	Z20823	1	1003587	4014486460230
6	CYLINDER DRIVE - 1075 + 1075 HY 4	Z37473	1	1003589	4014486460315
7	FAN DRIVE VARIABLE SPEED	Z34405	1	1000675	4014486470475
8	FAN DRIVE VARIABLE SPEED	Z41178	1	1001396	4014486459012
9	FROM NR. 44137	Z45026	1	1000261	4014486464177
10	1075 HY 4 (FROM NR. 44387)	Z45192	1	1002425	4014486493023
11	SHAKER SHAFT DRIVE	Z35965	1	1000153	4014486461756
12	STRAW WALKER DRIVE	Z33774	1	1000401	4014486466645
13		Z33790	1	1001995	4014486491180
14	MAIN DRIVE (GRAIN)	Z21501	1	1001102	4014486496840
14	MAIN DRIVE - 1075/1075 HY 4 (MAIZE)	Z38186	1	1001647	4014486485998
15	CUTTING TABLE DRIVE - 1072	Z39313	1	1001109	4014486496925
15	CUTTING TABLE DRIVE - 1075/1075 HY 4	Z39314	1	1001121	4014486497076
21	AIR CONDITIONING COMPRESSOR DRIVE SUB. FOR Z41889	Z42756	1	1002350	4014486478839
22		Z42757	1	1003343	4014486462975
23	HYDRAULIC PUMP DRIVE	Z34828	1	1003397	4014486462821

JOHN DEERE 1072 - 1075 - 1075 HYDRO 4



No.	Application	OEM - PN	Set	Optibelt AP-Nr.	EAN
24	DISCHARGE BEATER DRIVE	Z47911	1	1000604	4014486469363
31	MAIN DRIVE (1075)	AZ22914	2	1002915	4014486496918
32	1075	Z34099	1	1001523	4014486460421
33	1075 HY 4	Z41728	1	1001828	4014486488494
41		Z43863	1	1000036	4014486460735

BISO - Schrottenecker
 BIZON
 CASE INTL. HARVESTER
 CLAAS
 DEUTZ-FAHR
 DRONNING-BORG
 FENDT
 FORTSCHRITT
 JOHN DEERE
 KRONE
 LAVERDA
 MASSEY FERGUSON
 NEW HOLLAND
 ROSTSELMASH

JOHN DEERE 1075 HYDRO 4



No.	Application	OEM - PN	Set	Optibelt AP-Nr.	EAN
1	CUTTING TABLE DRIVE LEAD-IN	Z33790	1	1001995	4014486491180
2	DISCHARGE BEATER DRIVE	Z33368	1	1000603	4014486469370
4	HYDROSTATIC PUMP DRIVE	Z34828	1	1003397	4014486462821
5	SHAKER SHAFT DRIVE	Z35965	1	1000153	4014486461756
7	LEAD-IN DRIVE	Z21501	1	1001102	4014486496840
7	LEAD-IN DRIVE	Z38186	1	1001647	4014486485998
8	CUTTING TABLE DRIVE	Z39314	1	1001121	4014486497076
10	ROTARY SCREEN DRIVE	Z34786	1	1000040	4014486460773
10	ROTARY SCREEN DRIVE	Z37192	1	1004106	4014486522815
11	ROTARY SCREEN DRIVE	Z37191	1	1004105	4014486522761
12	CYLINDER VARIATOR DRIVE	Z37473	1	1003589	4014486460315
13	FAN DRIVE VARIABLE SPEED	Z34405	1	1000675	4014486470475
14	FAN DRIVE VARIABLE SPEED	Z41178	1	1001396	4014486459012
16	REEL DRIVE VARIABLE SPEED	Z36813	1	1001397	4014486459036
17	REEL DRIVE VARIABLE SPEED	Z20562	1	1000753	4014486471526
18	HYDROSTATIC PUMP DRIVE	Z41728	1	1001828	4014486488494
22	STRAW WALKER DRIVE	Z33774	1	1000401	4014486466645

JOHN DEERE 1085 - 1085 HYDRO 4



No.	Application	OEM - PN	Set	Optibelt AP-Nr.	EAN
2	FAN DRIVE (TO NR. 44386)	Z38703	1	1002344	4014486478778
4	ROTARY SCREEN - 1085 (TO NR. 44386) - 1085 HY4	Z38704	1	1000039	4014486460766
6	CYLINDER VARIATOR DRIVE	Z37473	1	1003589	4014486460315
7	FAN DRIVE VARIABLE SPEED	Z34405	1	1000675	4014486470475
8	FAN DRIVE VARIABLE SPEED	Z41178	1	1001396	4014486459012
9	1085 (FROM NR. 44387)	Z45191	1	1000003	4014486458992
10	1085 (FROM NR. 44387)	Z34786	1	1000040	4014486460773
12	1085 (FROM NR. 44387)	Z45192	1	1002425	4014486493023
12	1085 HY 4 (FROM NR. 44387)	Z45367	1	1002426	4014486493030
13	FROM NR. 44137	Z45026	1	1000261	4014486464177
21	SHAKER SHAFT DRIVE	Z35965	1	1000153	4014486461756
22	STRAW WALKER DRIVE	Z33774	1	1000401	4014486466645
23	CUTTING TABLE DRIVE LEAD-IN - 1085 (FROM NR. 44387)	Z33790	1	1001995	4014486491180
24		Z43890	1	1003643	4014486489156
31		Z42756	1	1002350	4014486478839
32	AIR CONDITIONING COMPRESSOR DRIVE (FROM NR. 33563)	Z42758	1	1000228	4014486463088
33	HYDRAULIC PUMP DRIVE	Z34828	1	1003397	4014486462821
34		Z47912	1	1000607	4014486469455
41	MAIN DRIVE (1085)	AZ22914	2	1002915	4014486496918
42	MAIN DRIVE (1085)	Z34099	1	1001523	4014486460421
51		Z43863	1	1000036	4014486460735

JOHN DEERE 1166 - 1166 HYDRO 4



No.	Application	OEM - PN	Set	Optibelt AP-Nr.	EAN
2	1166	AZ37807	2	1001108	4014486496901
3	1166	Z34099	1	1001523	4014486460421
5	1166	Z42756	1	1002350	4014486478839
6	1166	Z45482	1	1003400	4014486462906
7		Z34828	1	1003397	4014486462821
8		Z51212	1	1001027	4014486487800
9		Z46759	1	1002333	4014486478648
10		Z35965	1	1000153	4014486461756
12		Z33790	1	1001995	4014486491180
13	DRIVE GRAIN	Z21501	1	1001102	4014486496840
13	MAIZE	Z38186	1	1001647	4014486485998
14		Z39313	1	1001109	4014486496925
14	FOR LONG FEEDER HOUSE	Z39314	1	1001121	4014486497076
15		AR72036	1	1002351	4014486478846
16		Z46764	1	1004107	4014486522822
17		Z32190	1	1000002	4014486458985
18		Z45026	1	1000261	4014486464177
19	SUB FOR Z20823	Z53288	1	1001507	4014486460223
19		Z44936	1	1001542	4014486460612
19		Z20823	1	1003587	4014486460230
21		Z47912	1	1000607	4014486469455
22		Z46365	1	1001404	4014486459104

JOHN DEERE 1166 - 1166 HYDRO 4, 1169 - 1169 HYDRO 4

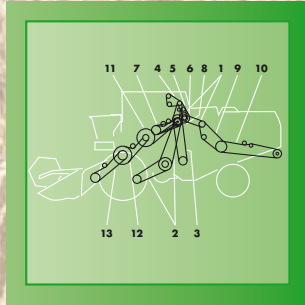
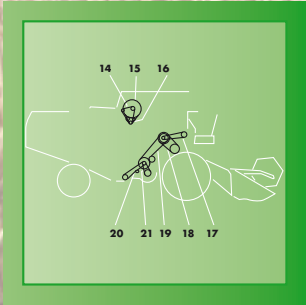

23	1166	Z43863	1	1000036	4014486460735
4	AIR CONDITIONING COMPRESSOR DRIVE WITH SEPARATE CONDENSER COOLING - 1169	Z42756	1	1002350	4014486478839
5	ONLY 1169	Z45482	1	1003400	4014486462906
6		Z34828	1	1003397	4014486462821
7		Z51212	1	1001027	4014486487800
8	AIR CONDITIONING COMPRESSOR DRIVE	Z46759	1	1002333	4014486478648
9		Z35965	1	1000153	4014486461756
11		Z33790	1	1001995	4014486491180
12	MAIZE	Z21501	1	1001102	4014486496840
12	DRIVE GRAIN	Z38186	1	1001647	4014486485998
13		Z39312	1	1001118	4014486497038
14		AR72036	1	1002351	4014486478846
15		Z46764	1	1004107	4014486522822
16		Z32190	1	1000002	4014486458985
17		Z45026	1	1000261	4014486464177
18	SUB FOR Z20823	Z53288	1	1001507	4014486460223
18		Z20823	1	1003587	4014486460230
20		Z47912	1	1000607	4014486469455
21		Z46365	1	1001404	4014486459104

JOHN DEERE 1174 - 1174 HYDRO 4



No.	Application	OEM - PN	Set	Optibelt AP-Nr.	EAN
1		Z43863	1	1000036	4014486460735
2		Z38704	1	1000039	4014486460766
3	1174 - FOR POSITORQUE GROUND SPEED DRIVE	AZ37807	2	1001108	4014486496901
4	1174 - FOR POSITORQUE GROUND SPEED DRIVE	Z34099	1	1001523	4014486460421
5	1174 HY 4 ONLY	Z41728	1	1001828	4014486488494
6	AIR CONDITIONING WITH SEPARATE CONDENSER COOLING	Z42756	1	1002350	4014486478839
7		Z45482	1	1003400	4014486462906
8		Z34828	1	1003397	4014486462821
9		Z51212	1	1001027	4014486487800
10	AIR CONDITIONING WITH INTEGRATED CONDENSER COOLING	Z46759	1	1002333	4014486478648
11		Z35965	1	1000153	4014486461756
13		Z33790	1	1001995	4014486491180
14		Z21501	1	1001102	4014486496840
14		Z38186	1	1001647	4014486485998
15		Z39313	1	1001109	4014486496925
15	FOR FEEDER CONVEYOR LONG	Z39314	1	1001121	4014486497076
16	AIR CONDITIONING WITH SEPARATE CONDENSER COOLING	Z38704	1	1000039	4014486460766
16	1174 ONLY AC WITH INTEGRATED CONDENSER COOLING	Z46764	1	1004107	4014486522822
17		AR72036	1	1002351	4014486478846
18	1174 HY 4 ONLY	Z45367	1	1002426	4014486493030
19		Z32190	1	1000002	4014486458985
20		Z45026	1	1000261	4014486464177

JOHN DEERE 1174 - 1174 HYDRO 4

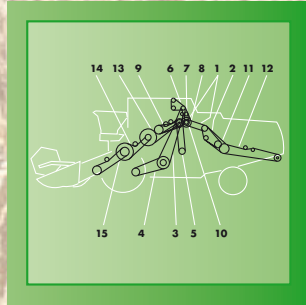
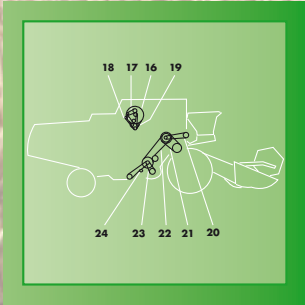

21	SUB FOR Z20823	Z53288	1	1001507	4014486460223
21		Z44936	1	1001542	4014486460612
21		Z20823	1	1003587	4014486460230
23		Z46365	1	1001404	4014486459104
24		Z47912	1	1000607	4014486469455

JOHN DEERE 1177 - 1177 HYDRO 4

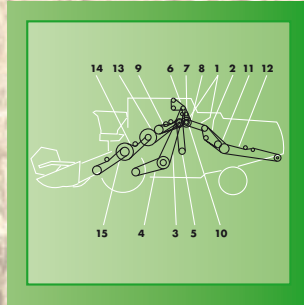
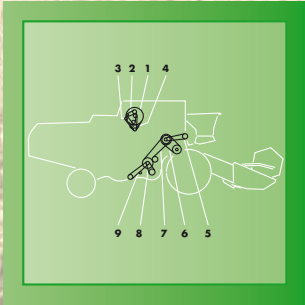

No.	Application	OEM - PN	Set	Optibelt AP-Nr.	EAN
1	1177 ONLY- AC WITH INTEGRATED CONDENSER COOLING	Z46764	1	1004107	4014486522822
2	1177 ONLY	AR72036	1	1002351	4014486478846
3		Z45367	1	1002426	4014486493030
5		Z45026	1	1000261	4014486464177
6		Z44936	1	1001542	4014486460612
8		Z46365	1	1001404	4014486459104
9		Z47912	1	1000607	4014486469455
10		Z35965	1	1000153	4014486461756
12	1177 ONLY	Z33790	1	1001995	4014486491180
13		Z38186	1	1001647	4014486485998
14		Z39314	1	1001121	4014486497076
15	AIR CONDITIONING WITH SEPARATE CONDENSER COOLING	Z42756	1	1002350	4014486478839
16	1177 HY 4	Z42757	1	1003343	4014486462975
16	1177 ONLY	Z45482	1	1003400	4014486462906
17		Z34828	1	1003397	4014486462821
18		Z51212	1	1001027	4014486487800
19	1177 ONLY- AC WITH INTEGRATED CONDENSER COOLING	Z46759	1	1002333	4014486478648
20	1177	AZ37807	2	1001108	4014486496901
21	1177	Z34099	1	1001523	4014486460421
22	1177 HY 4	Z46709	1	1001832	4014486488555
23		Z43863	1	1000036	4014486460735
24	WITHOUT CROOS SHAKER	Z38704	1	1000039	4014486460766

JOHN DEERE 1188 - 1188 HYDRO 4

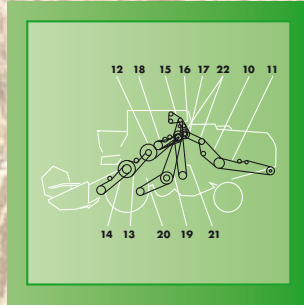
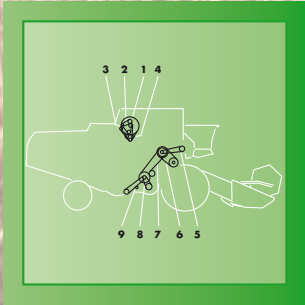

No.	Application	OEM - PN	Set	Optibelt AP-Nr.	EAN
1		Z51707	1	1001634	4014486485820
3		Z38704	1	1000039	4014486460766
5		Z45367	1	1002426	4014486493030
6		Z45026	1	1000261	4014486464177
8		Z44936	1	1001542	4014486460612
9		Z46365	1	1001404	4014486459104
10		Z47912	1	1000607	4014486469455
12		Z35965	1	1000153	4014486461756
13		Z46463	1	1001261	4014486492200
15		Z43890	1	1003643	4014486489156
17		Z42756	1	1002350	4014486478839
18		Z34828	1	1003397	4014486462821
20	1188 ONLY	Z51212	1	1001027	4014486487800
22		Z34099	1	1001523	4014486460421
		Z43863	1	1000036	4014486460735

JOHN DEERE 4435 - 4435 HYDRO, 6600 SIDEHILL, 6700 S

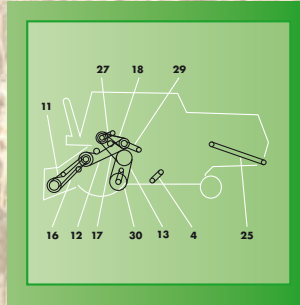
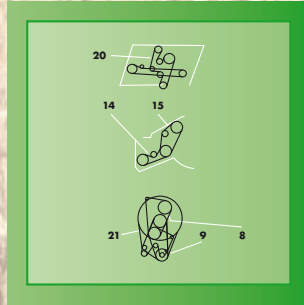
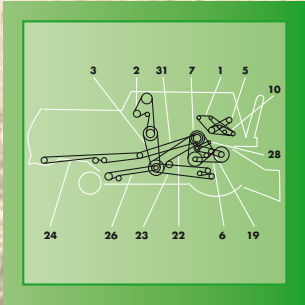

No.	Application	OEM - PN	Set	Optibelt AP-Nr.	EAN
1	ALTERNATOR AND WATERPUMP DRIVE	AR72036	1	1002351	4014486478846
2	CENTER SHAFT TO ROTARY SCREEN	Z46764	1	1004107	4014486522822
3	CRANKSHAFT - CENTER SHAFT	Z32190	1	1000002	4014486458985
4	CLEANING FAN DRIVE	Z46365	1	1001404	4014486459104
6	CYLINDER	Z44936	1	1001542	4014486460612
7	TAILINGS ELEVATOR DRIVE	Z45026	1	1000261	4014486464177
8	CLEAN GRAIN ELEVATOR DRIVE	Z47912	1	1000607	4014486469455
10	BEATER DRIVE	Z33790	1	1001995	4014486491180
11	FEEDER HOUSE DRIVE	Z38186	1	1001647	4014486485998
12	STRAW CHOPPER (FRONT)	Z44761	1	1001668	4014486486315
13	STRAW CHOPPER DRIVE (REAR)	Z47763	1	1001735	4014486487190
14	MAIN HYDRAULIC PUMP	Z34828	1	1003397	4014486462821
15	COMPRESSOR DRIVE	Z46759	1	1002333	4014486478648
16	UNLOADING AUGER DRIVE	Z51212	1	1001027	4014486487800
17	GROUND DRIVE (UPPER)	AZ37807	2	1001108	4014486496901
18	GROUND DRIVE (LOWER)	Z34099	1	1001523	4014486460421
21		Z55645	1	1001739	4014486487237
18	COUNTERSHAFT (PRIMARY)	H108175	1	1001140	4014486490022
1		R135199	1	1003235	4014486482669

JOHN DEERE 9500 SH



No.	Application	OEM - PN	Set	Optibelt AP-Nr.	EAN
1	AIR CONDITIONING COMPRESSOR (SN 650201-)	H80896	1	1002570	4014486495355
2	BEATER DRIVE (75 PERCENT)	AH163931	2	1001381	4014486474961
2	BEATER (100 PERCENT)	AH139436	2	1001382	4014486474978
3	CLEAN GRAIN ELEVATOR (SN 640201-)	H141167	1	1004088	4014486520088
4	COOLING FAN (HIGH POWER)	H153297	1	1001551	4014486484502
5	CYLINDER DR. REGULAR DUAL RANGE & SINGLE RANGE	H115881	1	1003663	4014486490817
7	FIXED SPEED FEEDER HOUSE WITH REVERSER	H126345	1	1001124	4014486497106
9	LOWER TAILINGS AUGER & ELEVATOR	N110085	1	1000702	4014486470857
10	OPTIONAL BEATER (75 PERCENT)	AH163931	2	1001381	4014486474961
12	SECONDARY COUNTERSHAFT	H128010	1	1000797	4014486472165
13	SHOE, STRAW WALKER & CONVEYOR AUGERS	H131169	1	1001392	4014486475104
14	STRAW CHOPPER DRIVE, SHORT REAR (SN 640201-)	H23950	1	1000682	4014486470581
14	STRAW CHOPPER DRIVE, LONG REAR	H125381	1	1000778	4014486471885
14	STRAW CHOPPER DRIVE, FRONT	H125380	1	1000791	4014486472073
14	STRAW CHOPPER DRIVE, REGULAR	H140404	1	1001434	4014486459425
15	STRAW SPREADER	H128234	1	1000419	4014486466829
16	UNLOADING SYSTEM	AH158880	2	1002861	4014486469400

JOHN DEERE 9510 SH



No.	Application	OEM - PN	Set	Optibelt AP-Nr.	EAN
1	AIR CONDITIONING COMPRESSOR	H80896	1	1002570	4014486495355
3	BEATER DRIVE (75 PERCENT)	AH163931	2	1001381	4014486474961
3	BEATER DRIVE (100 PERCENT)	AH139436	2	1001382	4014486474978
4	CHOPPER IN WINDROW OR FORWARD POSITION	H23950	1	1000682	4014486470581
4	CHOPPER IN REAR (OPERATING) POSITION	H125381	1	1000778	4014486471885
7	CYLINDER DR. REGULAR DUAL RANGE & SINGLE RANGE	H115881	1	1003663	4014486490817
10	FIXED SPEED FEEDER HOUSE WITH REVERSER	H126345	1	1001124	4014486497106
11	LOWER TAILINGS AUGER & ELEVATOR	N110085	1	1000702	4014486470857
14	SECONDARY COUNTERSHAFT	H128010	1	1000797	4014486472165
15	SHOE, STRAW WALKER & CONVEYOR AUGERS	H131169	1	1001392	4014486475104
16	STRAW CHOPPER DRIVE, FRONT	H125380	1	1000791	4014486472073
16	STRAW CHOPPER DRIVE, REGULAR (750-1350 RPM)	H140404	1	1001434	4014486459425
17	STRAW SPREADER	H128234	1	1000419	4014486466829
19	UNLOADING SYSTEM	AH158880	2	1002861	4014486469400

JOHN DEERE 9550 SH



No.	Application	OEM - PN	Set	Optibelt AP-Nr.	EAN
1	AIR CONDITIONING COMPRESSOR	H163515	1	1003209	4014486482256
2	ALTERNATOR (95 AMP)	H163515	1	1003209	4014486482256
2	ALTERNATOR (185 AMP)	H166870	1	1004090	4014486520521
3	BEATER DRIVE (75%)	AH163931	2	1001381	4014486474961
3	BEATER DRIVE (100%)	AH139436	2	1001382	4014486474978
4	CLEAN GRAIN ELEVATOR	H141166	1	1001394	4014486475128
5	CLEANING FAN (490 - 980 RPM)	H152180	1	1001431	4014486459395
5	CLEANING FAN (750 - 1350 RPM)	H152146	1	1001435	4014486459432
7	COUNTERSHAFT SECONDARY	H128010	1	1000797	4014486472165
9	CYLINDER DRIVE (240 - 960 RPM)	H115881	1	1003663	4014486490817
13	FIXED SPEED FEEDER HOUSE W/REVERSER (-700200)	H126345	1	1001124	4014486497106
15	LOWER TAILINGS AUGER & ELEVATOR	N110085	1	1000702	4014486470857
17	SHOE, WALKER, AND CONVEY OR AUGERS	H131169	1	1001392	4014486475104
18	STRAW CHOPPER (STANDARD BALING)	H23950	1	1000682	4014486470581
19	STRAW SPREADER	H128234	1	1000419	4014486466829
20	UNLOADING SYSTEM	AH158880	2	1002861	4014486469400

JOHN DEERE 9560 STS



No.	Application	OEM - PN	Set	Optibelt AP-Nr.	EAN
1	CLEAN GRAIN ELEVATOR DRIVE	H218645	1	1001393	4014486475111
2	JACKSHAFT - RIGHT HAND (REAR)	H154723	1	1000738	4014486471335
3	JACKSHAFT - (FRONT) RIGHT HAND	AH202773	2	1002893	4014486469820
4	FEEDER ACCELERATOR - STANDARD SPEED (SERIAL NR. 715301 - ...)	H211581	1	1004059	4014486519815
4	FEEDER ACCELERATOR - LOW SPEED	H221732	1	1004130	4014486523126
5	SHOE FAN AND CONVEYOR AUGERS	H175587	1	1004166	4014486523003
6	CLEANING FAN DRIVE	H206048	1	1001426	4014486459340
6	CLEANING FAN - SLOW SPEED (SUB FOR H206049)	H211601	1	1001433	4014486459418
7	TAILINGS AUGER AND ELEVATOR	H154731	1	1000586	4014486469073
8	HEADER AND REEL PUMP (STANDARD CAPACITY)	H126345	1	1001124	4014486497106
8	HEADER AND REEL PUMP (HIGH CAPACITY)	H209507	1	1004136	4014486523621
9	FEEDER HOUSE FIXED SPEED	H126345	1	1001124	4014486497106
10	UNLOADING AUGER DRIVE	AH160080	2	1000681	4014486470550
12	DISCHARGE BEATER DRIVE	H168301	1	1000708	4014486470956
13	COUNTERSHAFT - DISCHARGE BEATER AND CHOPPER	H157514	1	1004131	4014486523133
14	STRAW CHOPPER DRIVE	H204747	1	1001656	4014486486100
18	ALTERNATOR DRIVE (95 AMP)	R135606	1	1003191	4014486481846
18	ALTERNATOR DRIVE (185 AMP)	R135609	1	1003196	4014486481891

JOHN DEERE 9570 STS



BISO - Schrattecker
BIZON
CASE INTL. HARVESTER
CLAAS
DEUTZ-FAHR
DRONNING-BORG
FENDT
FORTSCHRITT
JOHN DEERE
KRONE
LAVERDA
MASSEY FERGUSON
ROSTSELMASH
NEW HOLLAND

No.	Application	OEM - PN	Set	Optibelt AP-Nr.	EAN
1	CLEAN GRAIN ELEVATOR DRIVE	H218645	1	1001393	4014486475111
2	JACKSHAFT - RIGHT HAND (REAR)	H154723	1	1000738	4014486471335
2	JACKSHAFT - (FRONT) RIGHT HAND	AH202773	2	1002893	4014486469820
3	FEEDER ACCELERATOR - STANDARD SPEED	H236472	1	1004059	4014486519815
3	FEEDER ACCELERATOR - LOW SPEED	H221732	1	1004130	4014486523126
4	SHOE FAN AND CONVEYOR AUGERS	H175587	1	1004166	4014486523003
5	CLEANING FAN DRIVE	H230909	1	1004058	4014486518337
6	TAILINGS AUGER AND ELEVATOR	H154731	1	1000586	4014486469073
7	HEADER AND REEL PUMP (STANDARD CAPACITY)	H126345	1	1001124	4014486497106
7	HEADER AND REEL PUMP (HIGH CAPACITY)	H209507	1	1004136	4014486523621
8	FEEDER HOUSE FIXED SPEED	H203474	1	1004057	4014486519914
9	UNLOADING AUGER DRIVE	AH160080	2	1000681	4014486470550
11	DISCHARGE BEATER DRIVE	H219182	1	1000708	4014486470956
12	COUNTERSHAFT - BEATER AND CHOPPER (HIGH CAPACITY)	H201596	1	1001141	4014486519730
12	COUNTERSHAFT - BEATER AND CHOPPER (STANDARD CAPACITY)	H157514	1	1004131	4014486523133
13	STRAW CHOPPER DRIVE	H204747	1	1001656	4014486486100
15	ROTARY SCREEN DRIVE - ENGINE SIDE	H213353	1	1004109	4014486522846
15	ROTARY SCREEN DRIVE - SCREEN SIDE	H221273	1	1004112	4014486522877
16	ALTERNATOR DRIVE (200 AMP)	R521053	1	1004156	4014486523058

JOHN DEERE 965 HYDRO 4



No.	Application	OEM - PN	Set	Optibelt AP-Nr.	EAN
1	REEL DRIVE	Z20562	1	1000753	4014486471526
2	REEL DRIVE VARIABLE SPEED	Z20459	1	1003583	4014486459029
3	MAIN DRIVE	Z33790	1	1001995	4014486491180
4	UNLOADING SYSTEM	Z33368	1	1000603	4014486469370
5	HYDRAULIC PUMP DRIVE	Z34828	1	1003397	4014486462821
6	TRACTION DRIVE	AZ22914	2	1002915	4014486496918
8	STRAW ELEVATOR DRIVE	Z21500	1	1001103	4014486496857
11	PURIFY DRIVE	Z31283	1	1000038	4014486460759
12	COUNTERSHAFT - PURIFY DRIVE	Z32190	1	1000002	4014486458985
13	CYLINDER DRIVE	Z20823	1	1003587	4014486460230
14	FAN DRIVE	Z34405	1	1000675	4014486470475
15	SICKLE KNIFE DRIVE	Z30130	1	1001111	4014486496949

JOHN DEERE 9650 CTS



No.	Application	OEM - PN	Set	Optibelt AP-Nr.	EAN
1	ALTERNATOR (95 AMP) (-695400)	H163515	1	1003209	4014486482256
1	ALTERNATOR (185 AMP) (-695400)	H166870	1	1004090	4014486520521
2	COUNTERSHAFT SECONDARY	H128010	1	1000797	4014486472165
2	CONVEYOR AUGER, SIEVE, AND CHAFFER	H131169	1	1001392	4014486475104
2		H165708	1	1001579	4014486484861
2	ALTERNATOR (185 AMP) (695401-)	R164820	1	1003114	4014486480641
3	COOLING FAN (695401-)	H177186	1	1003223	4014486482508
6	CLEAN GRAIN ELEVATOR	H141166	1	1001394	4014486475128
9	CYLINDER DRIVE (2830E.L.)	H115881	1	1003663	4014486490817
10	LOWER TAILINGS AUGER & ELEVATOR	N110085	1	1000702	4014486470857
12	CLEANING FAN (490 - 980 RPM)	H152180	1	1001431	4014486459395
12	CLEANING FAN (750 - 1350 RPM)	H152146	1	1001435	4014486459432
13	FIXED SPEED FEEDER HOUSE W/REVERSER (-700400_	H126345	1	1001124	4014486497106
17	OVERSHOT BEATER DRIVE	H139963	1	1000221	4014486462852
17	OVERSHOT BEATER DRIVE (740-1170 RPM)	H165708	1	1001579	4014486484861
18	STRIPPER BEATER DRIVE	H165708	1	1001579	4014486484861
19	UNLOADING SYSTEM	AH158880	2	1002861	4014486469400

JOHN DEERE 9650 STS

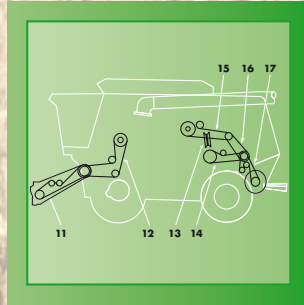
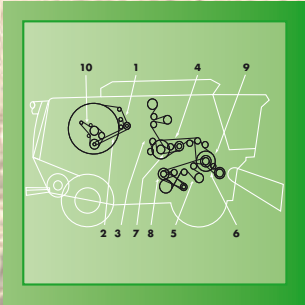

No.	Application	OEM - PN	Set	Optibelt AP-Nr.	EAN
1	ROTARY SCREEN DRIVE	H206807	1	1002435	4014486493139
2	ROTARY SCREEN DRIVE	H157104	1	1002437	4014486493153
3	ELEVATOR DRIVE GRAIN	H158512	1	1000853	4014486472844
4	JACKSHAFT - RIGHT HAND (REAR)	H154723	1	1000738	4014486471335
5	SHOE FAN AND CONVEYOR AUGERS	H175587	1	1004166	4014486523003
7	TAILINGS AUGER AND ELEVATOR	H154731	1	1000586	4014486469073
8	CLEANING FAN DRIVE	H165072	1	1001425	4014486459326
9	JACKSHAFT RIGHT HAND	AH150678	2	1002892	4014486470192
10	ALTERNATOR DRIVE 95 AMP	R135606	1	1003191	4014486481846
12	HEADER AND REEL PUMP	H156541	1	1001785	4014486519662
14	DISCHARGE BEATER DRIVE	H168301	1	1000708	4014486470956
15	UNLOADING AUGER DRIVE	AH160080	2	1000681	4014486470550
16	COUNTERSHAFT - BEATER AND CHOPPER	H157514	1	1004131	4014486523133
17	STRAW CHOPPER DRIVE	H204747	1	1001656	4014486486100

JOHN DEERE 9660 STS

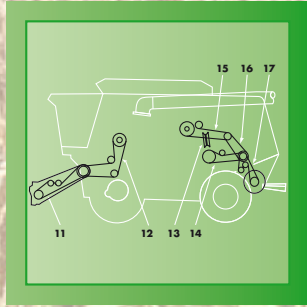
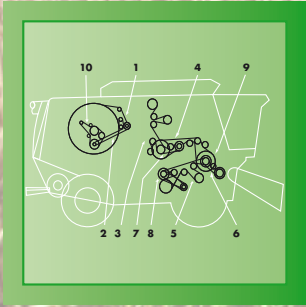

No.	Application	OEM - PN	Set	Optibelt AP-Nr.	EAN
1	CLEAN GRAIN ELEVATOR	H218645	1	1001393	4014486475111
1	CLEAN GRAIN ELEVATOR DRIVE	H218645	1	1001393	4014486475111
2	R.H. JACKSHAFT, REAR	H154723	1	1000738	4014486471335
2	JACKSHAFT - RIGHT HAND (REAR)	H154723	1	1000738	4014486471335
2	R.H. JACKSHAFT, FRONT	AH150678	2	1002892	4014486470192
3	JACKSHAFT - (FRONT) RIGHT HAND	AH150678	2	1002892	4014486470192
3	FEED ACCELERATOR, STANDARD SPEED 715401-	H236472	1	1004059	4014486519815
3	FEED ACCELERATOR, SLOW SPEED	H221732	1	1004130	4014486523126
4	FEEDER ACCELERATOR - STANDARD SPEED (SERIAL NR. 715301 - ...)	H211581	1	1004059	4014486519815
4	FEEDER ACCELERATOR - LOW SPEED	H221732	1	1004130	4014486523126
4	SHOE FAN AND CONVEYOR AUGERS	H175587	1	1004166	4014486523003
5	CLEANING FAN	H206048	1	1001426	4014486459340
5	CLEANING FAN, SLOW SPEED	H211601	1	1001433	4014486459418
5	SHOE FAN AND CONVEYOR AUGERS	H175587	1	1004166	4014486523003
6	TAILINGS AUGER AND ELEVATOR	H154731	1	1000586	4014486469073
6	CLEANING FAN DRIVE	H206048	1	1001426	4014486459340
6	CLEANING FAN - SLOW SPEED	H211601	1	1001433	4014486459418
7	TAILINGS AUGER AND ELEVATOR	H154731	1	1000586	4014486469073
7	HEADER AND REEL PUMP, HIGH CAPACITY	H156541	1	1001785	4014486519662
8	UNLOADING AUGER SYSTEM	AH160080	2	1000681	4014486470550
8	HEADER AND REEL PUMP (HIGH CAPACITY)	H156541	1	1001785	4014486519662
9	FEEDER HOUSE FIXED SPEED	H203474	1	1004057	4014486519914

JOHN DEERE 9660 STS

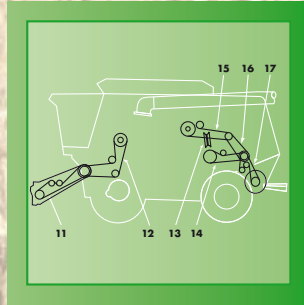
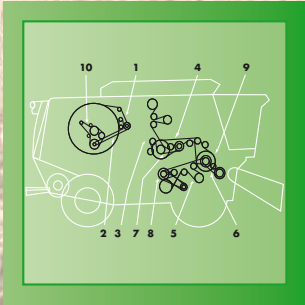

No.	Application	OEM - PN	Set	Optibelt AP-Nr.	EAN
10	UNLOADING AUGER DRIVE	AH160080	2	1000681	4014486470550
10	DISCHARGE BEATER	H219182	1	1000708	4014486470956
12	DISCHARGE BEATER DRIVE	H168301	1	1000708	4014486470956
12	STRAW CHOPPER	H235564	1	1001656	4014486486100
13	COUNTERSHAFT - DISCHARGE BEATER AND CHOPPER	H157514	1	1004131	4014486523133
14	STRAW CHOPPER DRIVE	H204747	1	1001656	4014486486100
14	FIXED SPEED FEEDER HOUSE	H203474	1	1004057	4014486519914
15	ROTARY SCREEN DRIVE, SCREEN SIDE -715400	H175628	1	1000180	4014486462098
15	ROTARY SCREEN DRIVE, ENGINE SIDE -715400	H206807	1	1002435	4014486493139
15	ROTARY SCREEN DRIVE, ENGINE SIDE 715401-	H213353	1	1004109	4014486522846
16	ALTERNATOR, 95 AMP	R135606	1	1003191	4014486481846
16	ALTERNATOR, 185 AMP	R135609	1	1003196	4014486481891
16	ALTERNATOR, 200 AMP	AT262958	1	1003226	4014486482560
17	ROTARY SCREEN DRIVE - ENGINE SIDE	H206807	1	1002435	4014486493139
18	ALTERNATOR DRIVE (95 AMP)	R135606	1	1003191	4014486481846
18	ALTERNATOR DRIVE (185 AMP)	R135609	1	1003196	4014486481891

JOHN DEERE 9670 STS

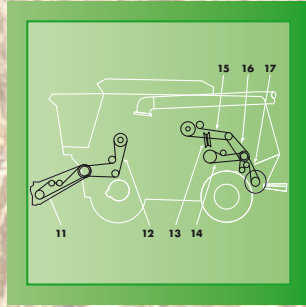
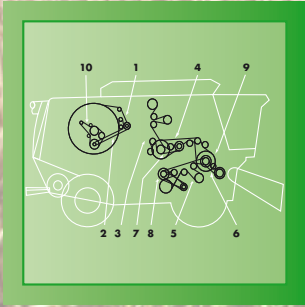

No.	Application	OEM - PN	Set	Optibelt AP-Nr.	EAN
1	CLEAN GRAIN ELEVATOR	H218645	1	1001393	4014486475111
1	CLEAN GRAIN ELEVATOR DRIVE	H218645	1	1001393	4014486475111
2	R.H. JACKSHAFT, REAR	H154723	1	1000738	4014486471335
2	JACKSHAFT - RIGHT HAND (REAR)	H154723	1	1000738	4014486471335
2	R.H. JACKSHAFT, FRONT	AH150678	2	1002892	4014486470192
2	JACKSHAFT - (FRONT) RIGHT HAND	AH150678	2	1002892	4014486470192
3	FEED ACCELERATOR, STANDARD SPEED	H236472	1	1004059	4014486519815
3	FEEDER ACCELERATOR - STANDARD SPEED	H236472	1	1004059	4014486519815
3	FEED ACCELERATOR, SLOW SPEED	H221732	1	1004130	4014486523126
3	FEEDER ACCELERATOR - LOW SPEED	H221732	1	1004130	4014486523126
3	SHOE FAN AND CONVEYOR AUGERS	H175587	1	1004166	4014486523003
4	CLEANING FAN	H206048	1	1001426	4014486459340
4	SHOE FAN AND CONVEYOR AUGERS	H175587	1	1004166	4014486523003
5	TAILINGS AUGER AND ELEVATOR	H154731	1	1000586	4014486469073
5	CLEANING FAN DRIVE	H206048	1	1001426	4014486459340
6	TAILINGS AUGER AND ELEVATOR	H154731	1	1000586	4014486469073
7	HEADER AND REEL PUMP (VARIABLE SPEED)	H156541	1	1001785	4014486519662
7	HEADER AND REEL PUMP (VARIABLE CAPACITY)	H156541	1	1001785	4014486519662
7	HEADER AND REEL (MULTI SPEED FEEDER HOUSE DRIVE)	H229018	1	1004145	4014486523652
8	UNLOADING AUGER SYSTEM	AH160080	2	1000681	4014486470550
8	FEEDER HOUSE FIXED SPEED	H203474	1	1004057	4014486519914
8	FEEDER HOUSE FIXED SPEED (EXTRA HEAVY DUTY)	H229019	1	1004144	4014486523645

JOHN DEERE 9670 STS

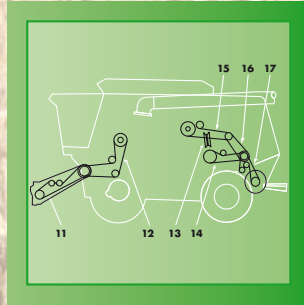
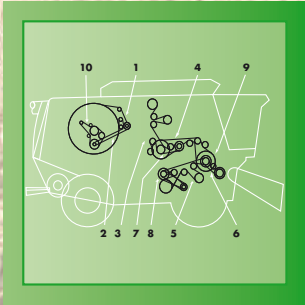

No.	Application	OEM - PN	Set	Optibelt AP-Nr.	EAN
9	UNLOADING AUGER DRIVE	AH160080	2	1000681	4014486470550
10	DISCHARGE BEATER	H219182	1	1000708	4014486470956
11	DISCHARGE BEATER DRIVE	H168301	1	1000708	4014486470956
12	COUNTERSHAFT - BEATER AND CHOPPER (STANDARD CAPACITY)	H157514	1	1004131	4014486523133
12	COUNTERSHAFT, DISCHARGE BEATER AND CHOPPER (REGULAR)	HXE10556	1	1004133	4014486523157
12	COUNTERSHAFT - BEATER AND CHOPPER (HIGH CAPACITY)	H223384	1	1004142	4014486523225
13	STRAW CHOPPER	H232997	1	1001606	4014486485325
13	STRAW CHOPPER DRIVE	H232997	1	1001606	4014486485325
13	STRAW CHOPPER (CIS)	H204747	1	1001656	4014486486100
13	STRAW CHOPPER (CIS)	H235564	1	1001656	4014486486100
13	COUNTERSHAFT, DISCHARGE BEATER AND CHOPPER (HEAVY DUTY)	HXE10501	1	1004142	4014486523225
15	FIXED SPEED FEEDER HOUSE	H203474	1	1004057	4014486519914
15	ROTARY SCREEN DRIVE - ENGINE SIDE	H213353	1	1004109	4014486522846
15	ROTARY SCREEN DRIVE, SCREEN SIDE	H221273	1	1004112	4014486522877
15	ROTARY SCREEN DRIVE - SCREEN SIDE	H221273	1	1004112	4014486522877
15	FIXED SPEED FEEDER HOUSE (MULTI SPEED FEEDER HOUSE DRIVE)	H229019	1	1004144	4014486523645
16	ALTERNATOR, 200 AMP	AT262958	1	1003226	4014486482560
16	ALTERNATOR DRIVE (200 AMP)	AT262958	1	1003226	4014486482560
16	ROTARY SCREEN DRIVE, ENGINE SIDE	H213353	1	1004109	4014486522846

JOHN DEERE 9750 STS

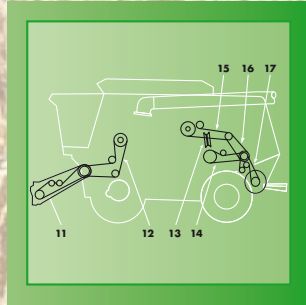
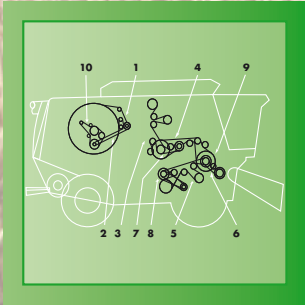

No.	Application	OEM - PN	Set	Optibelt AP-Nr.	EAN
1	ROTARY SCREEN DRIVE	H206807	1	1002435	4014486493139
2	ROTARY SCREEN DRIVE	H157104	1	1002437	4014486493153
3	ELEVATOR DRIVE GRAIN	H158512	1	1000853	4014486472844
4	JACKSHAFT - RIGHT HAND (REAR)	H154723	1	1000738	4014486471335
5	SHOE FAN AND CONVEYOR AUGERS	H175587	1	1004166	4014486523003
7	TAILINGS AUGER AND ELEVATOR	H154731	1	1000586	4014486469073
8	CLEANING FAN DRIVE	H165072	1	1001425	4014486459326
9	JACKSHAFT RIGHT HAND	AH150678	2	1002892	4014486470192
10	ALTERNATOR DRIVE 95 AMP	R135606	1	1003191	4014486481846
12	HEADER AND REEL PUMP	H156541	1	1001785	4014486519662
14	DISCHARGE BEATER DRIVE	H168301	1	1000708	4014486470956
15	UNLOADING AUGER DRIVE	AH160080	2	1000681	4014486470550
16	COUNTERSHAFT - BEATER AND CHOPPER	H157514	1	1004131	4014486523133
17	STRAW CHOPPER DRIVE	H204747	1	1001656	4014486486100

JOHN DEERE 9760 STS



No.	Application	OEM - PN	Set	Optibelt AP-Nr.	EAN
1	CLEAN GRAIN ELEVATOR DRIVE	H218645	1	1001393	4014486475111
2	JACKSHAFT - RIGHT HAND (REAR)	H154723	1	1000738	4014486471335
3	JACKSHAFT - (FRONT) RIGHT HAND	AH150678	2	1002892	4014486470192
4	FEEDER ACCELERATOR - STANDARD SPEED (SERIAL NR. 715301 - ...)	H211581	1	1004059	4014486519815
4	FEEDER ACCELERATOR - LOW SPEED	H221732	1	1004130	4014486523126
5	SHOE FAN AND CONVEYOR AUGERS	H175587	1	1004166	4014486523003
6	CLEANING FAN DRIVE	H206048	1	1001426	4014486459340
6	CLEANING FAN - SLOW SPEED	H211601	1	1001433	4014486459418
7	TAILINGS AUGER AND ELEVATOR	H154731	1	1000586	4014486469073
8	HEADER AND REEL PUMP (HIGH CAPACITY)	H156541	1	1001785	4014486519662
9	FEEDER HOUSE FIXED SPEED	H203474	1	1004057	4014486519914
10	UNLOADING AUGER DRIVE	AH160080	2	1000681	4014486470550
12	DISCHARGE BEATER DRIVE	H168301	1	1000708	4014486470956
13	COUNTERSHAFT - DISCHARGE BEATER AND CHOPPER	H157514	1	1004131	4014486523133
14	STRAW CHOPPER DRIVE	H204747	1	1001656	4014486486100
17	ROTARY SCREEN DRIVE - ENGINE SIDE	H206807	1	1002435	4014486493139
18	ALTERNATOR DRIVE (95 AMP)	R135606	1	1003191	4014486481846
18	ALTERNATOR DRIVE (185 AMP)	R135609	1	1003196	4014486481891

JOHN DEERE 9770 STS



BISO - Schrattecker
BIZON
CASE INTL. HARVESTER
CLAAS
DEUTZ-FAHR
DRONNING-BORG
FENDT
FORTSCHRITT
JOHN DEERE
KRONE
LAVERDA
MASSEY FERGUSON
ROSTSELMASH
NEW HOLLAND

No.	Application	OEM - PN	Set	Optibelt AP-Nr.	EAN
1	CLEAN GRAIN ELEVATOR DRIVE	H218645	1	1001393	4014486475111
2	JACKSHAFT - RIGHT HAND (REAR)	H154723	1	1000738	4014486471335
2	JACKSHAFT - (FRONT) RIGHT HAND	AH150678	2	1002892	4014486470192
3	FEEDER ACCELERATOR - STANDARD SPEED	H236472	1	1004059	4014486519815
3	FEEDER ACCELERATOR - LOW SPEED	H221732	1	1004130	4014486523126
4	SHOE FAN AND CONVEYOR AUGERS	H175587	1	1004166	4014486523003
5	CLEANING FAN DRIVE	H206048	1	1001426	4014486459340
6	TAILINGS AUGER AND ELEVATOR	H154731	1	1000586	4014486469073
7	HEADER AND REEL PUMP (VARIABLE CAPACITY)	H156541	1	1001785	4014486519662
7	HEADER AND REEL PUMP (MULTI SPEED FEEDER HOUSE DRIVE)	H229018	1	1004145	4014486523652
8	FEEDER HOUSE FIXED SPEED	H203474	1	1004057	4014486519914
8	FEEDER HOUSE VARIABLE DRIVE	H229019	1	1004144	4014486523645
9	UNLOADING AUGER DRIVE	AH160080	2	1000681	4014486470550
11	DISCHARGE BEATER DRIVE	H168301	1	1000708	4014486470956
12	COUNTERSHAFT - BEATER AND CHOPPER (STANDARD CAPACITY)	H157514	1	1004131	4014486523133
12	COUNTERSHAFT - BEATER AND CHOPPER (HIGH CAPACITY)	H223384	1	1004142	4014486523225
13	STRAW CHOPPER (CIS)	H204747	1	1001656	4014486486100
13	STRAW CHOPPER DRIVE	H223212	1	1004134	4014486523164
15	ROTARY SCREEN DRIVE - ENGINE SIDE	H213353	1	1004109	4014486522846
15	ROTARY SCREEN DRIVE - SCREEN SIDE	H221273	1	1004112	4014486522877
16	ALTERNATOR DRIVE (200 AMP)	AT262958	1	1003226	4014486482560

JOHN DEERE 9860 STS, 9870 STS



No.	Application	OEM - PN	Set	Optibelt AP-Nr.	EAN
1	HEADER AND REEL PUMP (HIGH CAPACITY)	H156541	1	1001785	4014486519662
2	FEEDER HOUSE FIXED SPEED (EXTRA HEAVY DUTY)	H174885	1	1002641	4014486480597
2	FEEDER HOUSE FIXED SPEED	H203474	1	1004057	4014486519914
3	UNLOADING AUGER DRIVE	AH160080	2	1000681	4014486470550
5	DISCHARGE BEATER DRIVE	H168301	1	1000708	4014486470956
6	COUNTERSHAFT - DISCHARGE BEATER AND CHOPPER	H201596	1	1001141	4014486519730
7	STRAW CHOPPER DRIVE	H217352	1	1001772	4014486519617
9	CLEAN GRAIN ELEVATOR DRIVE	H218645	1	1001393	4014486475111
10	JACKSHAFT - RIGHT HAND (REAR)	H154723	1	1000738	4014486471335
11	JACKSHAFT - (FRONT) RIGHT HAND	AH150678	2	1002892	4014486470192
12	FEEDER ACCELERATOR - STANDARD SPEED (SERIAL NR. 715301-..)	H211581	1	1004059	4014486519815
12	FEEDER ACCELERATOR - LOW SPEED	H221732	1	1004130	4014486523126
13	CLEANING FAN DRIVE	H206048	1	1001426	4014486459340
13	CLEANING FAN - SLOW SPEED	H211601	1	1001433	4014486459418
14	TAILINGS AUGER AND ELEVATOR	H154731	1	1000586	4014486469073
1	CLEAN GRAIN ELEVATOR DRIVE	H223230	1	1004137	4014486523416
2	JACKSHAFT - RIGHT HAND (REAR)	H154723	1	1000738	4014486471335
2	JACKSHAFT - (FRONT) RIGHT HAND	AH150678	2	1002892	4014486470192
3	FEEDER ACCELERATOR - STANDARD SPEED	H236472	1	1004059	4014486519815
3	FEEDER ACCELERATOR - LOW SPEED	H221732	1	1004130	4014486523126
3	FEEDER ACCELERATOR - HIGH SPEED (SERIAL NR. 730101-..)	H230230	1	1004138	4014486523263

JOHN DEERE 9870 STS



4	SHOE FAN AND CONVEYOR AUGERS	H175587	1	1004166	4014486523003
5	CLEANING FAN DRIVE	H230909	1	1004058	4014486518337
6	TAILINGS AUGER AND ELEVATOR	H154731	1	1000586	4014486469073
7	HEADER AND REEL PUMP	H156541	1	1001785	4014486519662
7	HEADER AND REEL PUMP (MULTI SPEED FEEDER HOUSE DRIVE)	H229018	1	1004145	4014486523652
8	FEEDER HOUSE FIXED SPEED (EXTRA HEAVY DUTY)	H174885	1	1002641	4014486480597
8	FEEDER HOUSE VARIABLE DRIVE	H229019	1	1004144	4014486523645
9	UNLOADING AUGER DRIVE	AH160080	2	1000681	4014486470550
11	DISCHARGE BEATER DRIVE	H219182	1	1000708	4014486470956
11	DISCHARGE BEATER DRIVE (CIS)	H168301	1	1000708	4014486470956
12	COUNTERSHAFT - BEATER AND CHOPPER (CIS)	H157514	1	1004131	4014486523133
12	COUNTERSHAFT - BEATER AND CHOPPER (STANDARD CAPACITY)	H223385	1	1004133	4014486523157
12	COUNTERSHAFT - BEATER AND CHOPPER (HEAVY DUTY)	H223384	1	1004142	4014486523225
13	STRAW CHOPPER (CIS)	H204747	1	1001656	4014486486100
13	STRAW CHOPPER DRIVE	H223212	1	1004134	4014486523164
14	ROTARY SCREEN DRIVE - ENGINE SIDE	H213353	1	1004109	4014486522846
14	ROTARY SCREEN DRIVE - SCREEN SIDE	H221273	1	1004112	4014486522877
15	ALTERNATOR DRIVE	R503505	1	1003207	4014486482171
16	ENGINE FAN DRIVE	R503312	1	1002614	4014486484182

JOHN DEERE CTS

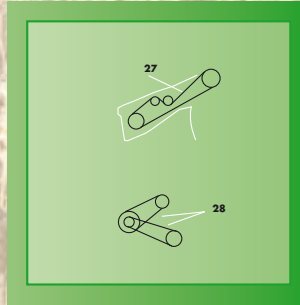
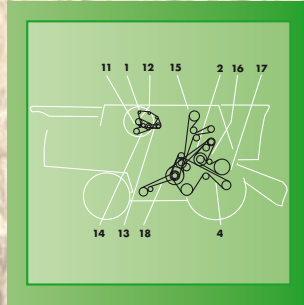
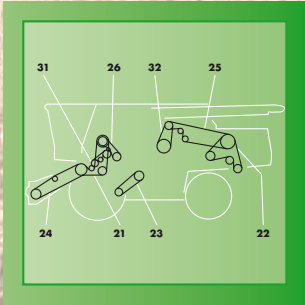

No.	Application	OEM - PN	Set	Optibelt AP-Nr.	EAN
2	COUNTERSHAFT (SECONDARY)	H128010	1	1000797	4014486472165
2	COUNTERSHAFT (SECONDARY)	H128010	1	1000797	4014486472165
4	STRAW WALKER - CONVEYOR AUGERS	H131169	1	1001392	4014486475104
4	STRAW WALKER - CONVEYOR AUGERS	H131169	1	1001392	4014486475104
11	COOLING FAN	H153297	1	1001551	4014486484502
11	COOLING FAN	H153297	1	1001551	4014486484502
15	CLEANING ELEVATOR (GRAIN)	H141167	1	1004088	4014486520088
15	CLEANING ELEVATOR (GRAIN)	H141167	1	1004088	4014486520088
16	CYLINDER DRIVE INTERMEDIATE	H115759	1	1001543	4014486460636
16	CYLINDER DRIVE INTERMEDIATE	H162629	1	1001543	4014486460636
16	CYLINDER DRIVE INTERMEDIATE	H115759	1	1001543	4014486460636
16	CYLINDER DRIVE INTERMEDIATE	H162629	1	1001543	4014486460636
17	CYLINDER DRIVE	H115881	1	1003663	4014486490817
17	CYLINDER DRIVE	H115881	1	1003663	4014486490817
18	TAILINGS AUGER AND ELEVATOR (LOWER)	N110085	1	1000702	4014486470857
18	TAILINGS AUGER AND ELEVATOR (LOWER)	N110085	1	1000702	4014486470857
21	EQUIPMENT FRONT END	H140160	1	1003570	4014486497014
21	EQUIPMENT FRONT END	H140160	1	1003570	4014486497014
23	FAN DRIVE REGULAR (N=750-1350 RPM)	H140404	1	1001434	4014486459425
23	FAN DRIVE REGULAR (N=750-1350 RPM)	H140404	1	1001434	4014486459425
24	DRUM DRIVE VARIABLE SPEED	H125711	1	1001453	4014486459616
24	DRUM DRIVE VARIABLE SPEED	H125711	1	1001453	4014486459616

JOHN DEERE CTS

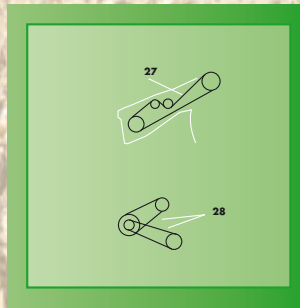
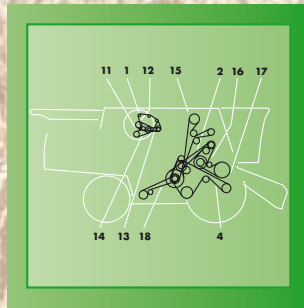
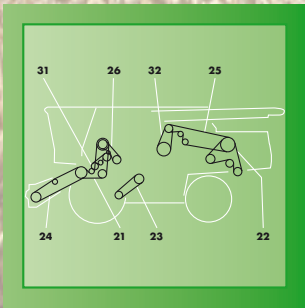

25	SEPARATOR DRIVE	H141429	1	1001149	4014486519792
25	SEPARATOR DRIVE	H141429	1	1001149	4014486519792
27	FEEDER HOUSE FIXED SPEED	H126345	1	1001124	4014486497106
27	FEEDER HOUSE FIXED SPEED	H126345	1	1001124	4014486497106
31	STRIPPER BEATER	H139963	1	1000221	4014486462852
31	STRIPPER BEATER	H139963	1	1000221	4014486462852
32	UNLOADING SYSTEM	AH127866	2	1003765	4014486469394
32	UNLOADING SYSTEM	AH127866	2	1003765	4014486469394

JOHN DEERE CTS 2

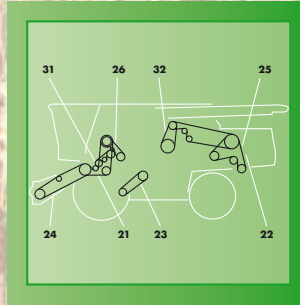
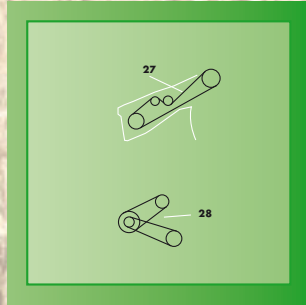
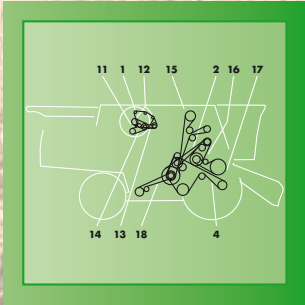

No.	Application	OEM - PN	Set	Optibelt AP-Nr.	EAN
1	ALTERNATOR DRIVE	H163515	1	1003209	4014486482256
2	COUNTERSHAFT (SECONDARY)	H128010	1	1000797	4014486472165
4	STRAW WALKER - CONVEYOR AUGERS	H131169	1	1001392	4014486475104
10	CYLINDER DRIVE INTERMEDIATE	H162629	1	1001543	4014486460636
11	CYLINDER DRIVE	H115881	1	1003663	4014486490817
13	STRIPPER BEATER	H139963	1	1000221	4014486462852
14	UNLOADING SYSTEM	AH127866	2	1003765	4014486469394
16	STRAW CHOPPER (FRONT)	H162541	1	1001774	4014486519624
17	SLOW SPEED (N=490-980 RPM) OPTIONAL	H152180	1	1001431	4014486459395
17	FAN DRIVE REGULAR (N=750-1350 RPM)	H152146	1	1001435	4014486459432
19	SEPARATOR DRIVE	H141429	1	1001149	4014486519792
21	FEEDER HOUSE FIXED SPEED	H126345	1	1001124	4014486497106

JOHN DEERE S 690



No.	Application	OEM - PN	Set	Optibelt AP-Nr.	EAN
1		H218645	1	1001393	4014486475111
2		H154723	1	1000738	4014486471335
3		AH150678	2	1002892	4014486470192
4	SLOW SPEED	H221732	1	1004130	4014486523126
5		H175587	1	1004166	4014486523003
6		H230909	1	1004058	4014486518337
8		H154731	1	1000586	4014486469073
9		H156541	1	1001785	4014486519662
9		H229018	1	1004145	4014486523652
11		AH160080	2	1000681	4014486470550
13		H219182	1	1000708	4014486470956
14		H228347	1	1004149	4014486523669
15		H228346	1	1004143	4014486523638
16		H174885	1	1002641	4014486480597
16		H229019	1	1004144	4014486523645

JOHN DEERE T 550



No.	Application	OEM - PN	Set	Optibelt AP-Nr.	EAN
1		H175628	1	1000180	4014486462098
2		H174455	1	1003217	4014486482454
4		Z59557	1	1001388	4014486475043
5		H141166	1	1001394	4014486475128
6		H128010	1	1000797	4014486472165
7		H115881	1	1003663	4014486490817
8		H176766	1	1001756	4014486519556
8	FOR HILLMASTER ONLY	H202821	1	1001759	4014486519563
9		Z103844	1	1001815	4014486488302
10	FOR N=900 RPM - 2 GROOVES	Z103845	1	1001571	4014486484748
10	FOR N=450 RPM - 3 GROOVES	Z103844	1	1001815	4014486488302
11		H139963	1	1000221	4014486462852
12		H177383	1	1001128	4014486497144
12	HEAVY DUTY VERSION	H176765	1	1001789	4014486519686
13		H152146	1	1001435	4014486459432
14		AH158880	2	1002861	4014486469400
15		H177177	1	1001905	4014486489668
16	FOR CORN	H177178	1	1001913	4014486489767
17		Z59286	1	1001911	4014486489736

JOHN DEERE T 560



No.	Application	OEM - PN	Set	Optibelt AP-Nr.	EAN
1		H175628	1	1000180	4014486462098
2		H174455	1	1003217	4014486482454
4		Z59557	1	1001388	4014486475043
5		H141166	1	1001394	4014486475128
6		H128010	1	1000797	4014486472165
7		H115881	1	1003663	4014486490817
8		H176766	1	1001756	4014486519556
8	FOR HILLMASTER ONLY	H202821	1	1001759	4014486519563
9		Z103844	1	1001815	4014486488302
10	FOR N=900 RPM - 2 GROOVES	Z103845	1	1001571	4014486484748
10	FOR N=450 RPM - 3 GROOVES	Z103844	1	1001815	4014486488302
11		H139963	1	1000221	4014486462852
12		H177383	1	1001128	4014486497144
12	HEAVY DUTY VERSION	H176765	1	1001789	4014486519686
13		H152146	1	1001435	4014486459432
14		AH158880	2	1002861	4014486469400
15		H177177	1	1001905	4014486489668
16	FOR CORN	H177178	1	1001913	4014486489767
17		Z59286	1	1001911	4014486489736

JOHN DEERE T 660



No.	Application	OEM - PN	Set	Optibelt AP-Nr.	EAN
1		H175628	1	1000180	4014486462098
2		H174455	1	1003217	4014486482454
4		Z59557	1	1001388	4014486475043
5		H141166	1	1001394	4014486475128
6		H128010	1	1000797	4014486472165
7		H115881	1	1003663	4014486490817
8		H176766	1	1001756	4014486519556
8	FOR HILLMASTER ONLY	H202821	1	1001759	4014486519563
9		Z103844	1	1001815	4014486488302
10	FOR N=900 RPM - 2 GROOVES	Z103845	1	1001571	4014486484748
10	FOR N=450 RPM - 3 GROOVES	Z103844	1	1001815	4014486488302
11		H139963	1	1000221	4014486462852
12		H176765	1	1001789	4014486519686
13		H152146	1	1001435	4014486459432
14		AH158880	2	1002861	4014486469400
15		H177177	1	1001905	4014486489668
16	FOR CORN	H177178	1	1001913	4014486489767
17		Z59286	1	1001911	4014486489736

JOHN DEERE T 670



No.	Application	OEM - PN	Set	Optibelt AP-Nr.	EAN
1		H175628	1	1000180	4014486462098
2		H174455	1	1003217	4014486482454
4		Z59557	1	1001388	4014486475043
5		H141166	1	1001394	4014486475128
6		H128010	1	1000797	4014486472165
7		H115881	1	1003663	4014486490817
8		H176766	1	1001756	4014486519556
8	FOR HILLMASTER ONLY	H202821	1	1001759	4014486519563
9		Z103844	1	1001815	4014486488302
10	FOR N=900 RPM - 2 GROOVES	Z103845	1	1001571	4014486484748
10	FOR N=450 RPM - 3 GROOVES	Z103844	1	1001815	4014486488302
11		H139963	1	1000221	4014486462852
12		H176765	1	1001789	4014486519686
13		H152146	1	1001435	4014486459432
14		AH158880	2	1002861	4014486469400
15		H177177	1	1001905	4014486489668
16	FOR CORN	H177178	1	1001913	4014486489767
17		Z59286	1	1001911	4014486489736

KRONE BIG X 1000, BIG X 500, BIG X 650



No.	Application	OEM - PN	Set	Optibelt AP-Nr.	EAN
1	MAIN DRIVE BIG X 1000	200211640	1	1004154	4014486523683
2	GRAIN CONDITIONER CPL TAFEL 31 - 37 BIG X 1000	2168800	1	1001294	4014486492460
3	CRACKER DRIVE / TENSIONING DEVICE BIG X 1000	2168800	1	1001294	4014486492460
6	VENTILATOR DRIVE BIG X 1000	200225361	1	1001584	4014486484915
7	SIEVE DRUM BIG X 1000	200208260	1	1004113	4014486522884
2	GRAIN CONDITIONER CPL TAFEL 31 - 37 BIG X 500	2168800	1	1001294	4014486492460
3	CRACKER DRIVE / TENSIONING DEVICE BIG X 500	2168800	1	1001294	4014486492460
6	SIEVE DRUM BIG X 500	2253610	1	1000182	4014486462111
1	MAIN DRIVE BIG X 650	2279101	1	1003580	4014486492897
2	GRAIN CONDITIONER CPL TAFEL 33 - 39 BIG X 650	2168800	1	1001294	4014486492460
3	CRACKER DRIVE / TENSIONING DEVICE BIG X 650	2168800	1	1001294	4014486492460
4	DIESEL ENGINE / CLUTCH / AIR CONDITIONER DRIVE BIG X 650	2282330	1	1003730	4014486495287
6	SUCTION SYSTEM DRIVE BIG X 650	2253560	1	1002363	4014486478976
6	SUCTION SYSTEM DRIVE BIG X 650	200216850	2	1004178	4014486523010
7	SIEVE DRUM BIG X 650	2253610	1	1000182	4014486462111

KRONE BIG X 800



No.	Application	OEM - PN	Set	Optibelt AP-Nr.	EAN
1	MAIN DRIVE BIG X 800	200211640	1	1004154	4014486523683
2	GRAIN CONDITIONER CPL TAFEL 31 - 37 BIG X 800	2168800	1	1001294	4014486492460
3	CRACKER DRIVE / TENSIONING DEVICE BIG X 800	2168800	1	1001294	4014486492460
6	VENTILATOR DRIVE BIG X 800	200225361	1	1001584	4014486484915
7	SIEVE DRUM BIG X 800	200208260	1	1004113	4014486522884

BISO - Schrottenecker
 BIZON
 CASE INTL. HARVESTER
 CLAAS
 DEUTZ-FAHR
 DRONNING-BORG
 FENDT
 FORTSCHRITT
 JOHN DEERE
 KRONE
 LAVERDA
 MASSEY FERGUSON
 NEW HOLLAND
 ROSTSELMASH

LAVERDA 3300, 3400

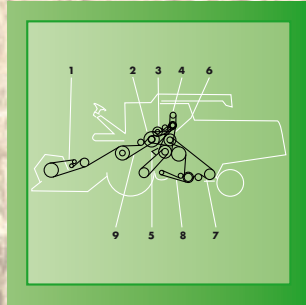
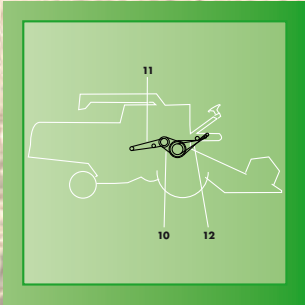

No.	Application	OEM - PN	Set	Optibelt AP-Nr.	EAN
7	AIR CONDITIONING COMPRESSOR DRIVE 292	H80896	1	1002570	4014486495355
24	COUNTERSHAFT (SECONDARY)	H138762	1	1000710	4014486470987
28	UNLOADING AUGER COUNTERSHAFT	H76136	1	1000542	4014486468243
3	THRESHING MECHANISM DRIVE	344311318	1	1002000	4014486491265
5	AIR CONDITIONED CAB INSTALLATION	340433129	1	1000104	4014486461077
6	TRANSMISSION	344311126	1	1003608	4014486485851
8	REAR BEATER TO DRIVE TRANSMISSION	340433539	1	1001120	4014486497069
10	STRAW WALKER DRIVE	340433316	1	1000367	4014486466294
11	AUGER DRIVES	340433446	1	1000787	4014486472035
12	RADIATOR FILTER TRANSMISSION	340433181	1	1003379	4014486461701
13	RADIATOR FILTER TRANSMISSION	340433134	1	1003369	4014486461107
14	DRUM VARIATOR	340435147	1	1003848	4014486460261
15	FAN VARIATOR	340435150	1	1001422	4014486459296
16	FAN VARIATOR	340435151	1	1001419	4014486459265
17	FAN DRIVE	340433191	1	1000170	4014486461961
18	SECONDARY CLEANER DRIVE	340433469	1	1000624	4014486520262

LAVERDA 3500



No.	Application	OEM - PN	Set	Optibelt AP-Nr.	EAN
1	REEL DRIVE VARIABLE SPEED	340434138	1	1001061	4014486496451
2	COMPRESSOR DRIVE	340433129	1	1000104	4014486461077
3	FILTER ROTARY (SECONDARY)	340433134	1	1003369	4014486461107
5		340433191	1	1000170	4014486461961
7	STRAW WALKER DRIVE	340433316	1	1000367	4014486466294
8		344311126	1	1003608	4014486485851
10	CYLINDER DRIVE	344311318	1	1002000	4014486491265
13	CONVERTER DRIVE	340433422	1	1000606	4014486520514
14		340433469	1	1000624	4014486520262
16	AUGER DRIVE TAILINGS AND GRAIN	340433446	1	1000787	4014486472035
19	RETURN DRIVE	340433539	1	1001120	4014486497069
20	CYLINDER DRIVE	340435147	1	1003848	4014486460261

LAVERDA 3550, 3600

No.	Application	OEM - PN	Set	Optibelt AP-Nr.	EAN
1	AIR CONDITIONED CAB INSTALLATION	340433129	1	1000104	4014486461077
2	STRAW WALKER DRIVE	340433316	1	1000367	4014486466294
3	AUGER DRIVE	340433446	1	1000787	4014486472035
5	REAR BEATER TO DRIVE TRANSMISSION	340433539	1	1001120	4014486497069
8	TRANSMISSION	344311126	1	1003608	4014486485851
10	THRESHING MECHANISM DRIVE	344311318	1	1002000	4014486491265
11	RADIATOR FILTER TRANSMISSION	340433181	1	1003379	4014486461701
12	DRUM VARIATOR	340435147	1	1003848	4014486460261
13	FAN VARIATOR	340435150	1	1001422	4014486459296
14	FAN VARIATOR	340435151	1	1001419	4014486459265
15	RADIATOR FILTER TRANSMISSION	340433134	1	1003369	4014486461107
1		344311127	1	1001637	4014486485868
4	AUGER DRIVE TAILINGS AND GRAIN	344311134	1	1004071	4014486520347
8	COMPRESSOR DRIVE	340433129	1	1000104	4014486461077
11	CYLINDER VARIATOR DRIVE	344311318	1	1002000	4014486491265
12	REEL DRIVE VARIABLE SPEED	340434138	1	1001061	4014486496451
16	CYLINDER DRIVE	340435152	1	1001539	4014486460582

LAVERDA 3650, 3700

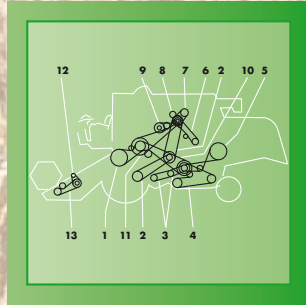
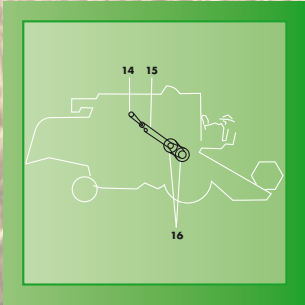

No.	Application	OEM - PN	Set	Optibelt AP-Nr.	EAN
1	REEL DRIVE VARIABLE SPEED	340434138	1	1001061	4014486496451
2	COMPRESSOR DRIVE	340433129	1	1000104	4014486461077
7		344311127	1	1001637	4014486485868
8	AUGER DRIVE TAILINGS AND GRAIN	344311134	1	1004071	4014486520347
10	CYLINDER DRIVE	344311318	1	1002000	4014486491265
12	CONVERTER DRIVE	340433422	1	1000606	4014486520514
15	STRAW WALKER DRIVE	340433457	1	1003833	4014486519945
16	RETURN DRIVE	340433539	1	1001120	4014486497069
17	MAIN FAN	340435150	1	1001422	4014486459296
18	CYLINDER VARIATOR DRIVE	340435152	1	1001539	4014486460582
1		344311127	1	1001637	4014486485868
4	AUGER DRIVE TAILINGS AND GRAIN	344311134	1	1004071	4014486520347
8	COMPRESSOR DRIVE	340433129	1	1000104	4014486461077
11	CYLINDER VARIATOR DRIVE	344311318	1	1002000	4014486491265
12	REEL DRIVE VARIABLE SPEED	340434138	1	1001061	4014486496451

LAVERDA 3750, 3790



No.	Application	OEM - PN	Set	Optibelt AP-Nr.	EAN
1	REEL DRIVE VARIABLE SPEED	340434138	1	1001061	4014486496451
2	COMPRESSOR DRIVE	340433129	1	1000104	4014486461077
7		344311127	1	1001637	4014486485868
8	AUGER DRIVE TAILINGS AND GRAIN	344311134	1	1004071	4014486520347
10	HYDRAULIC PUMP DRIVE	344311226	1	1001835	4014486488593
11	CYLINDER DRIVE	344311318	1	1002000	4014486491265
13	CONVERTER DRIVE	340433422	1	1000606	4014486520514
16	STRAW WALKER DRIVE	340433457	1	1003833	4014486519945
17	RETURN DRIVE	340433539	1	1001120	4014486497069
18	MAIN FAN	340435150	1	1001422	4014486459296
19	CYLINDER VARIATOR DRIVE	340435152	1	1001539	4014486460582
1	REEL DRIVE VARIABLE SPEED	340434138	1	1001061	4014486496451
2	COMPRESSOR DRIVE	340433129	1	1000104	4014486461077
7		344311127	1	1001637	4014486485868
8	AUGER DRIVE TAILINGS AND GRAIN	344311134	1	1004071	4014486520347
10	HYDRAULIC PUMP DRIVE	344311226	1	1001835	4014486488593
11	CYLINDER DRIVE	344311318	1	1002000	4014486491265
13	CONVERTER DRIVE	340433422	1	1000606	4014486520514
16	STRAW WALKER DRIVE	340433457	1	1003833	4014486519945
17	RETURN DRIVE	340433539	1	1001120	4014486497069
18	MAIN FAN	340435150	1	1001422	4014486459296

LAVERDA 3850, 3890, 3900

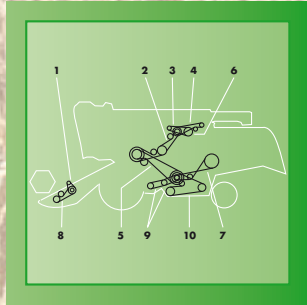
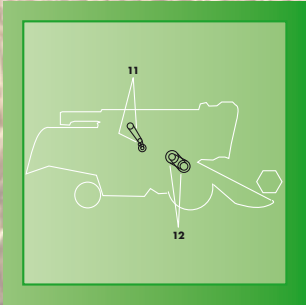

No.	Application	OEM - PN	Set	Optibelt AP-Nr.	EAN
1	REEL DRIVE VARIABLE SPEED	340434138	1	1001061	4014486496451
2	COMPRESSOR DRIVE	340433129	1	1000104	4014486461077
7	AUGER DRIVE TAILINGS AND GRAIN	344311134	1	1004071	4014486520347
9	CYLINDER DRIVE	344311318	1	1002000	4014486491265
12	CONVERTER (E)	340433422	1	1000606	4014486520514
13	STRAW WALKER DRIVE	340433457	1	1003833	4014486519945
15	RETURN DRIVE	340433539	1	1001120	4014486497069
16	MAIN FAN	340435150	1	1001422	4014486459296
1	REEL DRIVE VARIABLE SPEED	340434138	1	1001061	4014486496451
2	COMPRESSOR DRIVE	340433129	1	1000104	4014486461077
7	AUGER DRIVE TAILINGS AND GRAIN	344311134	1	1004071	4014486520347
9	HYDRAULIC PUMP DRIVE	344311226	1	1001835	4014486488593
10	CYLINDER VARIATOR DRIVE	344311318	1	1002000	4014486491265
14	CONVERTER (E)	340433422	1	1000606	4014486520514
15	STRAW WALKER DRIVE	340433457	1	1003833	4014486519945
17	RETURN DRIVE	340433539	1	1001120	4014486497069
18	MAIN FAN	340435150	1	1001422	4014486459296
1	REEL DRIVE VARIABLE SPEED	340434138	1	1001061	4014486496451
7	STRAW WALKER DRIVE	340433457	1	1003833	4014486519945
10	AUGER DRIVE TAILINGS AND GRAIN	344311134	1	1004071	4014486520347

LAVERDA 3350 (EX AL 112), 3400 R

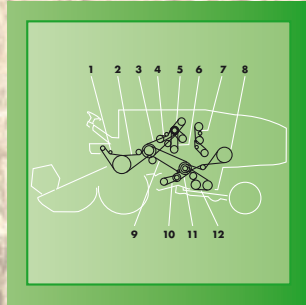
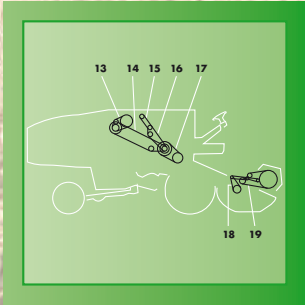

No.	Application	OEM - PN	Set	Optibelt AP-Nr.	EAN
2	ELEVATOR DRIVE UNIT	340433531	1	1000950	4014486474053
15	ROTARY FILTER (SECONDARY)	340433134	1	1003369	4014486461107
1	REEL DRIVE VARIABLE SPEED (1978)	340434138	1	1001061	4014486496451
13		340433531	1	1000950	4014486474053
14	REEL DRIVE (1978)	340433316	1	1000367	4014486466294
17	ROTARY FILTER DRIVE	340433134	1	1003369	4014486461107
3	THRESHING MECHANISM DRIVE	344311318	1	1002000	4014486491265
5	AIR CONDITIONED CAB INSTALLATION	340433129	1	1000104	4014486461077
6	TRANSMISSION	344311126	1	1003608	4014486485851
8	REAR BEATER TO DRIVE TRANSMISSION	340433539	1	1001120	4014486497069
10	STRAW WALKER DRIVE	340433316	1	1000367	4014486466294
11	AUGER DRIVE	340433446	1	1000787	4014486472035
12	RADIATOR FILTER TRANSMISSION	340433181	1	1003379	4014486461701
13	RADIATOR FILTER TRANSMISSION	340433134	1	1003369	4014486461107
14	DRUM VARIATOR	340435147	1	1003848	4014486460261
15	FAN VARIATOR	340435150	1	1001422	4014486459296
16	FAN VARIATOR	340435151	1	1001419	4014486459265
17	FAN DRIVE	340433191	1	1000170	4014486461961
18	SECONDARY CLEANER DRIVE	340433469	1	1000624	4014486520262

LAVERDA 3450 (EX AL 132), 3500 R

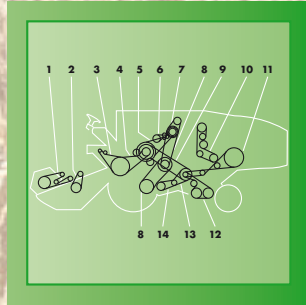
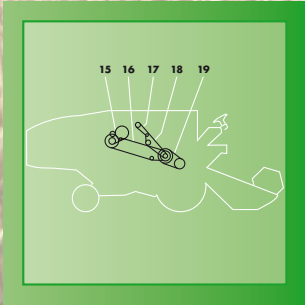

No.	Application	OEM - PN	Set	Optibelt AP-Nr.	EAN
1	REEL DRIVE (1978)	340433316	1	1000367	4014486466294
2	REEL DRIVE VARIABLE SPEED	340434138	1	1001061	4014486496451
4		340433531	1	1000950	4014486474053
17	ROTARY FILTER (SECONDARY)	340433134	1	1003369	4014486461107
1	AIR CONDITIONED CAB INSTALLATION	340433129	1	1000104	4014486461077
2	STRAW WALKER DRIVE	340433316	1	1000367	4014486466294
3	AUGER DRIVE	340433446	1	1000787	4014486472035
5	REAR BEATER TO DRIVE TRANSMISSION	340433539	1	1001120	4014486497069
8	TRANSMISSION	344311126	1	1003608	4014486485851
10	THRESHING MECHANISM DRIVE	344311318	1	1002000	4014486491265
11	RADIATOR FILTER TRANSMISSION	340433181	1	1003379	4014486461701
12	DRUM VARIATOR	340435147	1	1003848	4014486460261
13	FAN VARIATOR	340435150	1	1001422	4014486459296
14	FAN VARIATOR	340435151	1	1001419	4014486459265
15	RADIATOR FILTER TRANSMISSION	340433134	1	1003369	4014486461107

LAVERDA 3550 AL



No.	Application	OEM - PN	Set	Optibelt AP-Nr.	EAN
1		340434138	1	1001061	4014486496451
2		340433129	1	1000104	4014486461077
3		340433134	1	1003369	4014486461107
4		340433181	1	1003379	4014486461701
5		340433191	1	1000170	4014486461961
8		340433316	1	1000367	4014486466294
9		344311126	1	1003608	4014486485851
10		344311226	1	1001835	4014486488593
11		344311318	1	1002000	4014486491265
14		340433469	1	1000624	4014486520262
16		340433446	1	1000787	4014486472035
19		340433539	1	1001120	4014486497069
20		340435147	1	1003848	4014486460261

LAVERDA 3550 R



No.	Application	OEM - PN	Set	Optibelt AP-Nr.	EAN
1	AIR CONDITIONED CAB INSTALLATION	340433129	1	1000104	4014486461077
2	STRAW WALKER DRIVE	340433316	1	1000367	4014486466294
3	AUGER DRIVE	340433446	1	1000787	4014486472035
5	REAR BEATER TO DRIVE TRANSMISSION	340433539	1	1001120	4014486497069
8	TRANSMISSION	344311126	1	1003608	4014486485851
10	THRESHING MECHANISM DRIVE	344311318	1	1002000	4014486491265
11	RADIATOR FILTER TRANSMISSION	340433181	1	1003379	4014486461701
12	DRUM VARIATOR	340435147	1	1003848	4014486460261
13	FAN VARIATOR	340435150	1	1001422	4014486459296
14	FAN VARIATOR	340435151	1	1001419	4014486459265
15	RADIATOR FILTER TRANSMISSION	340433134	1	1003369	4014486461107

BISO - Schrattecker
 BIZON
 CASE INTL. HARVESTER
 CLAAS
 DEUTZ-FAHR
 DRONNING-BORG
 FENDT
 FORTSCHRITT
 JOHN DEERE
 KRONE
 LAVERDA
 MASSEY FERGUSON
 NEW HOLLAND
 ROSTSELMASH

LAVERDA L 517



No.	Application	OEM - PN	Set	Optibelt AP-Nr.	EAN
1	POST CYLINDER VARIATOR DRIVE	344311318	1	1002000	4014486491265
2	STRAW ELEVATOR DRIVE	344311127	1	1001637	4014486485868
2	STRAW ELEVATOR DRIVE	344312128	1	1003623	4014486487503
3	AUGER DRIVE TAILINGS AND GRAIN	344311123	1	1001622	4014486485554
4	FAN RETURN DRIVE	340433539	1	1001120	4014486497069
5	STRAW ELEVATOR DRIVE	340433474	1	1000789	4014486472059
6	DISCHARGE DRIVE GRAIN TANK	340433475	1	1000588	4014486469110
7	ROTARY FILTER DRIVE	340433181	1	1003379	4014486461701
8	CYLINDER VARIATOR DRIVE	340435152	1	1001539	4014486460582
9	FAN DRIVE	340435150	1	1001422	4014486459296
11	CENTRAL RETURN DRIVE	340433984	1	1001346	4014486474596
12	REEL DRIVE VARIABLE SPEED	340434138	1	1001061	4014486496451
13		340433422	1	1000606	4014486520514
14	COMPRESSOR DRIVE	340433131	1	1000106	4014486461091
16		340433260	1	1000241	4014486463552
17		340433270	1	1000256	4014486464054
18	CHOPPER DRIVE	344311130	1	1001652	4014486486056
19	CHOPPER DRIVE	344311151	1	1001717	4014486486995
21		344311228	1	1003630	4014486488333
36	FAN DRIVE	340433159	1	1000135	4014486461527
38	FAN DRIVE	340435153	1	1001424	4014486459319

LAVERDA L 521



BISO - Schrattecker
BIZON
CASE INTL. HARVESTER
CLAAS
DEUTZ-FAHR
DRONNING-BORG
FENDT
FORTSCHRITT
JOHN DEERE
KRONE
LAVERDA
MASSEY FERGUSON
NEW HOLLAND
ROTSSELMASH

No.	Application	OEM - PN	Set	Optibelt AP-Nr.	EAN
1	POST CYLINDER VARIATOR DRIVE	344311318	1	1002000	4014486491265
2	STRAW ELEVATOR DRIVE	344311127	1	1001637	4014486485868
2	STRAW ELEVATOR DRIVE	344312128	1	1003623	4014486487503
3	AUGER DRIVE TAILINGS AND GRAIN	344311123	1	1001622	4014486485554
4	FAN RETURN DRIVE	340433539	1	1001120	4014486497069
5	STRAW ELEVATOR DRIVE	340433474	1	1000789	4014486472059
6	DISCHARGE DRIVE GRAIN TANK	340433475	1	1000588	4014486469110
7	ROTARY FILTER DRIVE	340433181	1	1003379	4014486461701
8	CYLINDER VARIATOR DRIVE	340435152	1	1001539	4014486460582
9	FAN DRIVE	340435150	1	1001422	4014486459296
11	CENTRAL RETURN DRIVE	340433984	1	1001346	4014486474596
12	REEL DRIVE VARIABLE SPEED	340434138	1	1001061	4014486496451
13		340433422	1	1000606	4014486520514
14	COMPRESSOR DRIVE	340433131	1	1000106	4014486461091
15		340433262	1	1000244	4014486520156
17		340433270	1	1000256	4014486464054
18	CHOPPER DRIVE	344311130	1	1001652	4014486486056
19	CHOPPER DRIVE	344311151	1	1001717	4014486486995
20		340433151	1	1000124	4014486461367
20		340433253	1	1000231	4014486520491
22	HYDRAULIC PUMP DRIVE	344311227	1	1001820	4014486488371
36	FAN DRIVE	340433159	1	1000135	4014486461527

LAVERDA L 521, L 524

No.	Application	OEM - PN	Set	Optibelt AP-Nr.	EAN
37	HYDRAULIC PUMP DRIVE	340433259	1	1000225	4014486463033
38	FAN DRIVE	340435153	1	1001424	4014486459319
1	POST CYLINDER VARIATOR DRIVE	344311318	1	1002000	4014486491265
2	STRAW ELEVATOR DRIVE	344311127	1	1001637	4014486485868
2	STRAW ELEVATOR DRIVE	344312128	1	1003623	4014486487503
3	AUGER DRIVE TAILINGS AND GRAIN	344311123	1	1001622	4014486485554
4	FAN RETURN DRIVE	340433539	1	1001120	4014486497069
5	STRAW WALKER DRIVE	340433474	1	1000789	4014486472059
6	DISCHARGE DRIVE GRAIN TANK	340433475	1	1000588	4014486469110
8	CYLINDER VARIATOR DRIVE	340435152	1	1001539	4014486460582
9	FAN DRIVE	340435150	1	1001422	4014486459296
11	CENTRAL RETURN DRIVE	340433984	1	1001346	4014486474596
12	REEL DRIVE VARIABLE SPEED	340434138	1	1001061	4014486496451
13		340433422	1	1000606	4014486520514
14	COMPRESSOR DRIVE	340433131	1	1000106	4014486461091
15		340433262	1	1000244	4014486520156
17		340433270	1	1000256	4014486464054
18	CHOPPER DRIVE	344311130	1	1001652	4014486486056
19	CHOPPER DRIVE	344311151	1	1001717	4014486486995
20		340433151	1	1000124	4014486461367
20		340433253	1	1000231	4014486520491

LAVERDA L 524, L 624



22	HYDRAULIC PUMP DRIVE	344311227	1	1001820	4014486488371
36	FAN DRIVE	340433159	1	1000135	4014486461527
37	HYDRAULIC PUMP DRIVE	340433259	1	1000225	4014486463033
38	FAN DRIVE	340435153	1	1001424	4014486459319
1	POST CYLINDER VARIATOR DRIVE	344311318	1	1002000	4014486491265
2	STRAW ELEVATOR DRIVE	344311127	1	1001637	4014486485868
2	STRAW ELEVATOR DRIVE	344312128	1	1003623	4014486487503
3	AUGER DRIVE TAILINGS AND GRAIN	344311123	1	1001622	4014486485554
4	FAN RETURN DRIVE	340433539	1	1001120	4014486497069
5	STRAW ELEVATOR DRIVE	340433474	1	1000789	4014486472059
6	DISCHARGE DRIVE GRAIN TANK	340433475	1	1000588	4014486469110
7	ROTARY FILTER DRIVE	340433181	1	1003379	4014486461701
9	FAN DRIVE	340435150	1	1001422	4014486459296
11	CENTRAL RETURN DRIVE	340433984	1	1001346	4014486474596
12	REEL DRIVE VARIABLE SPEED	340434138	1	1001061	4014486496451
13		340433422	1	1000606	4014486520514
14	COMPRESSOR DRIVE	340433131	1	1000106	4014486461091
15		340433262	1	1000244	4014486520156
17		340433270	1	1000256	4014486464054
18	CHOPPER DRIVE	344311130	1	1001652	4014486486056
19	CHOPPER DRIVE	344311151	1	1001717	4014486486995

LAVERDA L 624, L 626

No.	Application	OEM - PN	Set	Optibelt AP-Nr.	EAN
20		340433151	1	1000124	4014486461367
20		340433253	1	1000231	4014486520491
22	HYDRAULIC PUMP DRIVE	344311227	1	1001820	4014486488371
36	FAN DRIVE	340433159	1	1000135	4014486461527
37		340433259	1	1000225	4014486463033
38		340435153	1	1001424	4014486459319
1	POST CYLINDER VARIATOR DRIVE	344311318	1	1002000	4014486491265
2	STRAW ELEVATOR DRIVE	344311127	1	1001637	4014486485868
2	STRAW ELEVATOR DRIVE	344312128	1	1003623	4014486487503
3	AUGER DRIVE TAILINGS AND GRAIN	344311123	1	1001622	4014486485554
4	FAN RETURN DRIVE	340433539	1	1001120	4014486497069
5	STRAW ELEVATOR DRIVE	340433474	1	1000789	4014486472059
6	DISCHARGE DRIVE GRAIN TANK	340433475	1	1000588	4014486469110
7	ROTARY FILTER DRIVE	340433181	1	1003379	4014486461701
9	FAN DRIVE	340435150	1	1001422	4014486459296
11	CENTRAL RETURN DRIVE	340433984	1	1001346	4014486474596
12	REEL DRIVE VARIABLE SPEED	340434138	1	1001061	4014486496451
13		340433422	1	1000606	4014486520514
14	COMPRESSOR DRIVE	340433131	1	1000106	4014486461091
15		340433262	1	1000244	4014486520156
17		340433270	1	1000256	4014486464054

LAVERDA L 626, M 112, M 112 AL, M 120, M 132, M 150, M 152



18	CHOPPER DRIVE	344311130	1	1001652	4014486486056
19	CHOPPER DRIVE	344311151	1	1001717	4014486486995
20		340433151	1	1000124	4014486461367
20		340433253	1	1000231	4014486520491
22	HYDRAULIC PUMP DRIVE	344311227	1	1001820	4014486488371
36	FAN DRIVE	340433159	1	1000135	4014486461527
38		340435153	1	1001424	4014486459319
13	STRAW ELEVATOR DRIVE	340433531	1	1000950	4014486474053
17	ROTARY FILTER DRIVE	340433134	1	1003369	4014486461107
2	STRAW ELEVATOR DRIVE	340433531	1	1000950	4014486474053
15	ROTARY FILTER DRIVE	340433134	1	1003369	4014486461107
3	ELEVATOR DRIVE (UPPER) SHAFT	340433531	1	1000950	4014486474053
4	STRAW ELEVATOR DRIVE	340433531	1	1000950	4014486474053
17	ROTARY FILTER RETURN DRIVE	340433134	1	1003369	4014486461107
3	STRAW ELEVATOR DRIVE	340433531	1	1000950	4014486474053
13	STRAW ELEVATOR DRIVE	340433531	1	1000950	4014486474053

LAVERDA M 84, M 90, MX 300

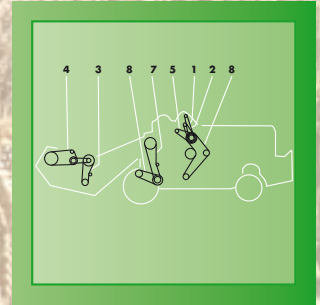
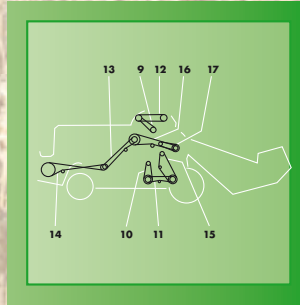
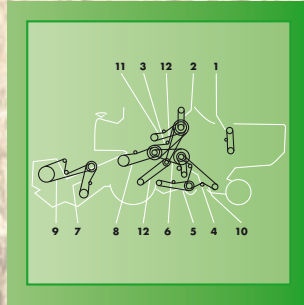
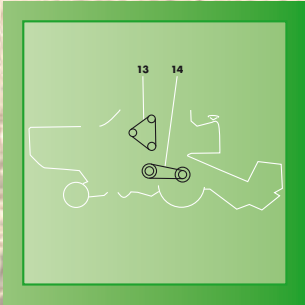

No.	Application	OEM - PN	Set	Optibelt AP-Nr.	EAN
1	FAN DRIVE (GRAIN)	340433131	1	1000106	4014486461091
12	ELEVATOR DRIVE GRAIN	340433272	1	1003430	4014486464245
8		344311117	1	1003592	4014486484939
9	CYLINDER DRIVE	344311127	1	1001637	4014486485868
11	HYDRAULIC PUMP DRIVE	344311227	1	1001820	4014486488371

MASSEY FERGUSON 24, 27, 29, 31



No.	Application	OEM - PN	Set	Optibelt AP-Nr.	EAN
5		41958500	1	1000859	4014486472936
9		41955900	1	1000704	4014486470888
13		41935700	1	1003447	4014486465464
14		41988700	1	1003562	4014486473452
15		41926300	1	1000230	4014486463187
16		41930300	1	1003426	4014486464092
8		41934800	3	1002768	4014486465228
10		41929000	1	1000251	4014486463897
14		41936200	2	1002770	4014486465648
8		41934800	3	1002768	4014486465228
14		41936200	2	1002770	4014486465648
8		41934800	3	1002768	4014486465228
14		41936200	2	1002770	4014486465648

MASSEY FERGUSON 187, 206



No.	Application	OEM - PN	Set	Optibelt AP-Nr.	EAN
1	TABLE FEEDER DRUM	1724154M1	1	1000647	4014486470079
1	TABLE FEEDER DRUM	417974M1	1	1000651	4014486470116
2	TANK UNLOADER DRIVE	621259M1	1	1000547	4014486468311
3	FANNING MILL (UPPER)	621261M1	1	1000284	4014486464641
4	HYDRAULIC PUMP DRIVE	417468M1	1	1003397	4014486462821
6	FANNING MILL	1721710M1	1	1002096	4014486475890
7	STRAW WALKER SHAKER	621258M1	1	1000346	4014486465983
9	TRACTION (LOWER)	905920M1	1	1001450	4014486459586
10	REDUCER	417972M1	1	1000885	4014486473261
12	KNIFE - BLADE CONTROL	1722835M1	1	1003502	4014486469097
12	KNIFE DRIVE	402607M1	1	1003515	4014486469653
15	FANNING MILL	621262M1	1	1003334	4014486462586
16	VENTILATOR	621262M1	1	1003334	4014486462586
19	OUTLET	418192M1	1	1000547	4014486468311
1	TABLE FEEDER DRUM	1724154M1	1	1000647	4014486470079
3	FANNING MILL (UPPER)	621261M1	1	1000284	4014486464641
6	FANNING MILL	1721710M1	1	1002096	4014486475890
7	SHAKER STRAW	621258M1	1	1000346	4014486465983
9	TRACTION (LOWER)	905920M1	1	1001450	4014486459586
10	REDUCER	417972M1	1	1000885	4014486473261
12	KNIFE - BLADE CONTROL	1722835M1	1	1003502	4014486469097

MASSEY FERGUSON 206, 240



12	KNIFE DRIVE	402607M1	1	1003515	4014486469653
13	FANNING MILL	621262M1	1	1003334	4014486462586
14	VENTILATION (SECONDARY)	621262M1	1	1003334	4014486462586
1	TABLE FEEDER DRUM	1724154M1	1	1000647	4014486470079
3	FANNING MILL (UPPER)	621261M1	1	1000284	4014486464641
7	STRAW WALKER SHAKER	621258M1	1	1000346	4014486465983
9	TRACTION (LOWER)	905920M1	1	1001450	4014486459586
10	REDUCER	417972M1	1	1000885	4014486473261
12	KNIFE DRIVE	1722835M1	1	1003502	4014486469097
12	KNIFE DRIVE	410959M1	1	1003512	4014486469516
12	KNIFE DRIVE	402607M1	1	1003515	4014486469653
13	REEL DRIVE	1604401M1	1	1000370	4014486466331
15	FANNING MILL	621262M1	1	1003334	4014486462586

MASSEY FERGUSON 300, 307

No.	Application	OEM - PN	Set	Optibelt AP-Nr.	EAN
	AIR CONDITIONING OR CLEAN FAN HIGH SPEED	834492M2	1	1000211	4014486462593
	AUGER (GRAIN)	227984M1	1	1000731	4014486471250
2	CLEANING FAN DRIVE	832877M1	1	1000232	4014486463262
5	REEL DRIVE	834140M1	1	1000734	4014486471281
5	REEL DRIVE VARIABLE SPEED	833768M1	1	1001402	4014486459081
7	HYDRAULIC PUMP DRIVE	230381M1	1	1003482	4014486468182
8	KNIFE DRIVE	834190M1	1	1000597	4014486469295
8	KNIFE DRIVE	834058M1	1	1000598	4014486469301
10	TRACTION (LOWER) (GRAIN)	832789M3	1	1001442	4014486459500
12	REEL DRIVE COUNTERSHAFT	834139M1	1	1000567	4014486468748
18	TANK UNLOADER DRIVE	832878M1	1	1000596	4014486469257
1	TABLE FEEDER DRUM	1724154M1	1	1000647	4014486470079
3	FANNING MILL (UPPER)	621261M1	1	1000284	4014486464641
5	BEATER / THRESHER	1603701M1	1	1001641	4014486485936
5	BEATER / THRESHER	1720255M1	1	1001871	4014486489125
6	FANNING MILL / VARIATOR	621262M1	1	1003334	4014486462586
7	STRAW WALKER SHAKER	621258M1	1	1000346	4014486465983
9	TRACTION (UPPER)	905920M1	1	1001450	4014486459586
10	CONTROL REDUCER UP TO 8.5 FEET / BAR	417972M1	1	1000885	4014486473261
12	KNIFE WOBBLE DRIVE	1722835M1	1	1003502	4014486469097
12	KNIFE FROM 10 FEET (2.2 M)	410959M1	1	1003512	4014486469516

MASSEY FERGUSON 307, 400



12	KNIFE UP TO 8.5 FEET (2.5 M)	402607M1	1	1003515	4014486469653
13	REEL DRIVE	1604401M1	1	1000370	4014486466331
15	FANNING MILL	621262M1	1	1003334	4014486462586
1	FANNING MILL	784797M2	1	1000214	4014486462708
3	FANNING MILL (UPPER)	1855008M1	1	1000572	4014486468809
5	HYDRAULIC PUMP DRIVE	832490M1	1	1001277	4014486474435
6	ALTERNATOR DRIVE	893575M1	1	1000060	4014486483802
10	RETURN DRIVE	795514M4	1	1000264	4014486464214
10	RETURN DRIVE	832538M1	1	1003431	4014486464313
11	SHAKER SHAFT DRIVE	1615254M1	1	1000765	4014486471687
11	SHAKER SHAFT DRIVE	320593M2	1	1001361	4014486474756
12	ELEVATOR DRIVE GRAIN	784796M2	1	1003546	4014486471243
15	REDUCER	789853M1	1	1001403	4014486459098
17	REEL DRIVE	785810M1	1	1000378	4014486466416
17	REEL DRIVE	1615333M1	1	1000743	4014486471397

MASSEY FERGUSON 440, 487, 500

No.	Application	OEM - PN	Set	Optibelt AP-Nr.	EAN
1	TABLE FEEDER DRUM	621588M1	1	1000668	4014486470352
3	FANNING MILL (UPPER)	621261M1	1	1000284	4014486464641
5	BEATER DRIVE	1720255M1	1	1001871	4014486489125
9	TRACTION (LOWER)	905920M1	1	1001450	4014486459586
12	KNIFE DRIVE	410959M1	1	1003512	4014486469516
13	REEL DRIVE	1604401M1	1	1000370	4014486466331
15	FANNING MILL	621262M1	1	1003334	4014486462586
2	VENTILATOR	621262M1	1	1003334	4014486462586
5	DEFLECTOR DRUM	1720255M1	1	1001871	4014486489125
6	OUTLET GRAIN	418192M1	1	1000547	4014486468311
7	BAR CONTROL	621588M1	1	1000668	4014486470352
1	FANNING MILL	784797M2	1	1000214	4014486462708
3	FANNING MILL (UPPER)	1855008M1	1	1000572	4014486468809
5	HYDRAULIC PUMP DRIVE	230381M1	1	1003482	4014486468182
6	ALTERNATOR DRIVE	893575M1	1	1000060	4014486483802
10	RETURN DRIVE	832538M1	1	1003431	4014486464313
11	SHAKER SHAFT DRIVE	320593M2	1	1001361	4014486474756
12	ELEVATOR DRIVE GRAIN	784796M2	1	1003546	4014486471243

MASSEY FERGUSON 507, 510

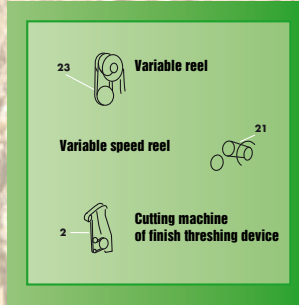
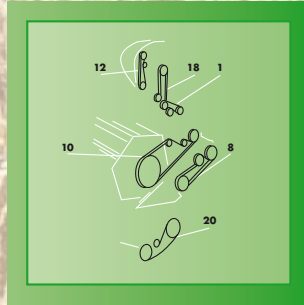
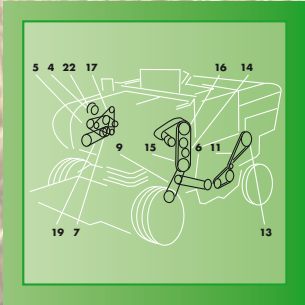

No.	Application	OEM - PN	Set	Optibelt AP-Nr.	EAN
2	VENTILATOR	621262M1	1	1003334	4014486462586
3	VENTILATOR	621261M1	1	1000284	4014486464641
4	STRAW SHAKER	621258M1	1	1000346	4014486465983
5	OUTLET GRAIN	905980M1	1	1001552	4014486484519
6	DEFLECTOR DRUM	1720205M3	1	1001889	4014486489460
7	BLADE CONTROL	410959M1	1	1003512	4014486469516
8	BAR CONTROL	621588M1	1	1000668	4014486470352
9	HYDRAULIC PUMP DRIVE	1720674M2	1	1000220	4014486462838
1	FANNING MILL	784797M2	1	1000214	4014486462708
3	FANNING MILL (UPPER)	1855008M1	1	1000572	4014486468809
5	HYDRAULIC PUMP DRIVE	230381M1	1	1003482	4014486468182
6	ALTERNATOR DRIVE	893575M1	1	1000060	4014486483802
10	RETURN DRIVE	795582M2	1	1000249	4014486463828
10	RETURN DRIVE	795514M4	1	1000264	4014486464214
11	SHAKER SHAFT DRIVE	1615254M1	1	1000765	4014486471687
12	ELEVATOR DRIVE GRAIN	784796M2	1	1003546	4014486471243
16	KNIFE DRIVE	785585M3	1	1004096	4014486518696
17	REEL DRIVE	1615333M1	1	1000743	4014486471397
17	REEL DRIVE	1615254M1	1	1000765	4014486471687

MASSEY FERGUSON 515

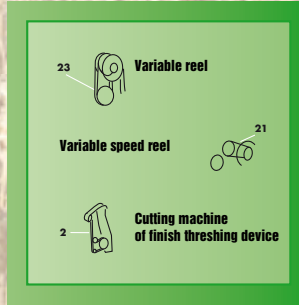
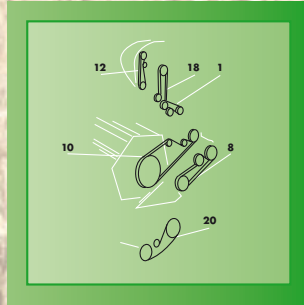
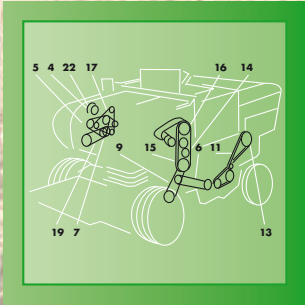

No.	Application	OEM - PN	Set	Optibelt AP-Nr.	EAN
1	FANNING MILL	784797M2	1	1000214	4014486462708
3	FANNING MILL (UPPER)	1855008M1	1	1000572	4014486468809
5	HYDRAULIC PUMP DRIVE	230381M1	1	1003482	4014486468182
6	ALTERNATOR DRIVE	893575M1	1	1000060	4014486483802
10	RETURN DRIVE	795582M2	1	1000249	4014486463828
10	RETURN DRIVE	795514M4	1	1000264	4014486464214
11	SHAKER SHAFT DRIVE	1615254M1	1	1000765	4014486471687
12	ELEVATOR DRIVE GRAIN	784796M2	1	1003546	4014486471243
16	KNIFE DRIVE	785585M3	1	1004096	4014486518696
17	REEL DRIVE	1615333M1	1	1000743	4014486471397
17	REEL DRIVE	1615254M1	1	1000765	4014486471687

MASSEY FERGUSON 520



No.	Application	OEM - PN	Set	Optibelt AP-Nr.	EAN
1	FANNING MILL	1616477M1	1	1000211	4014486462593
1	FANNING MILL	784797M2	1	1000214	4014486462708
2	TANK UNLOADER DRIVE	619317M2	1	1000563	4014486468656
3	FANNING MILL (UPPER)	789853M1	1	1001403	4014486459098
3	FANNING MILL (UPPER)	785585M3	1	1004096	4014486518696
6	ALTERNATOR DRIVE	893575M1	1	1000060	4014486483802
7	DRIVE	789967M1	1	1000986	4014486498066
8	MAIN BELT	789930M1	1	1002617	4014486498080
9	MULTI FLOW	784170M2	1	1000425	4014486466881
10	RETURN DRIVE	795582M2	1	1000249	4014486463828
10	RETURN DRIVE	795514M4	1	1000264	4014486464214
11	SHAKER SHAFT DRIVE	1615254M1	1	1000765	4014486471687
12	ELEVATOR DRIVE GRAIN	784796M2	1	1003546	4014486471243
15	REDUCER	789853M1	1	1001403	4014486459098
16	KNIFE DRIVE	785585M3	1	1004096	4014486518696
17	REEL DRIVE	785810M1	1	1000378	4014486466416
17	REEL DRIVE	1615333M1	1	1000743	4014486471397

MASSEY FERGUSON 525

No.	Application	OEM - PN	Set	Optibelt AP-Nr.	EAN
1	FANNING MILL	1616477M1	1	1000211	4014486462593
1	FANNING MILL	784797M2	1	1000214	4014486462708
2	TANK UNLOADER DRIVE	619317M2	1	1000563	4014486468656
3	FANNING MILL (UPPER)	789853M1	1	1001403	4014486459098
3	FANNING MILL (UPPER)	785585M3	1	1004096	4014486518696
6	ALTERNATOR DRIVE	893575M1	1	1000060	4014486483802
7	DRIVE	789967M1	1	1000986	4014486498066
8	MAIN BELT	789930M1	1	1002617	4014486498080
9	MULTI FLOW	784170M2	1	1000425	4014486466881
10	RETURN DRIVE	795582M2	1	1000249	4014486463828
10	RETURN DRIVE	795514M4	1	1000264	4014486464214
11	SHAKER SHAFT DRIVE	1615254M1	1	1000765	4014486471687
12	ELEVATOR DRIVE GRAIN	784796M2	1	1003546	4014486471243
15	REDUCER	789853M1	1	1001403	4014486459098
16	KNIFE DRIVE	785585M3	1	1004096	4014486518696
17	REEL DRIVE	785810M1	1	1000378	4014486466416
17	REEL DRIVE	1615333M1	1	1000743	4014486471397

MASSEY FERGUSON 530, 535



BISO - Schrattecker
BIZON
CASE INTL. HARVESTER
CLAAS
DEUTZ-FAHR
DRONNING-BORG
FENDT
FORTSCHRITT
JOHN DEERE
KRONE
LAVERDA
MASSEY FERGUSON
NEW HOLLAND
ROSTSELMASH

No.	Application	OEM - PN	Set	Optibelt AP-Nr.	EAN
1	FANNING MILL	784797M2	1	1000214	4014486462708
2	TANK UNLOADER DRIVE	3370141M1	1	1001746	4014486487305
3	FANNING MILL (UPPER)	785585M3	1	1004096	4014486518696
8	MAIN BELT	789930M1	1	1002617	4014486498080
9	MULTI FLOW	795582M2	1	1000249	4014486463828
10	RETURN DRIVE	795514M4	1	1000264	4014486464214
11	SHAKER SHAFT DRIVE	1615254M1	1	1000765	4014486471687
12	ELEVATOR DRIVE GRAIN	784796M2	1	1003546	4014486471243
16	KNIFE DRIVE	1724154M1	1	1000647	4014486470079
17	REEL DRIVE	843313M1	1	1001016	4014486497991
1	FANNING MILL	784797M2	1	1000214	4014486462708
2	TANK UNLOADER DRIVE	3370141M1	1	1001746	4014486487305
3	FANNING MILL (UPPER)	785585M3	1	1004096	4014486518696
8	MAIN BELT	789930M1	1	1002617	4014486498080
9	MULTI FLOW	795582M2	1	1000249	4014486463828
10	RETURN DRIVE	795514M4	1	1000264	4014486464214
11	SHAKER SHAFT DRIVE	1615254M1	1	1000765	4014486471687
12	ELEVATOR DRIVE GRAIN	784796M2	1	1003546	4014486471243
16	KNIFE DRIVE	1724154M1	1	1000647	4014486470079
17	REEL DRIVE	843313M1	1	1001016	4014486497991

MASSEY FERGUSON 540

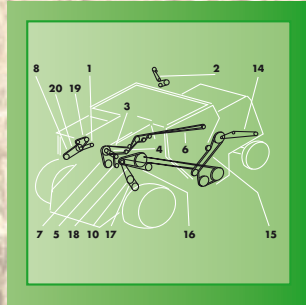
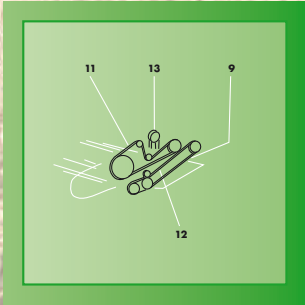

No.	Application	OEM - PN	Set	Optibelt AP-Nr.	EAN
1	AIR CONDITIONING COMPRESSOR DRIVE	843045M1	1	1002543	4014486494723
2	AUXILIARY CYLINDER (SLINGER)	834332M1	1	1000304	4014486465075
3	CHOPPER DRIVE - HIGH SPEED	843760M1	1	1000803	4014486472233
4	CLEANING FAN DRIVE	832877M1	1	1000232	4014486463262
8	AIR INTAKE DRIVE	240575M2	1	1002298	4014486479867
9	KNIFE WOBBLE - RIGID CUT BAR	834190M1	1	1000597	4014486469295
9	KNIFE WOBBLE - FLOATING CUT BAR	833962M1	1	1000673	4014486470444
10	BEATER (REAR)OR STRAW CHOPPER	843747M1	1	1000827	4014486472547
11	REEL DRIVE	834140M1	1	1000734	4014486471281
12	REEL DRIVE COUNTERSHAFT	834139M1	1	1000567	4014486468748
13	REEL DRIVE VARIABLE SPEED	833768M1	1	1001402	4014486459081
16	TANK UNLOADER DRIVE	832878M1	1	1000596	4014486469257
17	TRACTION (LOWER)	843732M2	1	1001443	4014486459517
18	TRACTION (UPPER)	844091M1	1	1001445	4014486459531
19	ALTERNATOR, FAN AND WATERPUMP DRIVE	532779M92	2	1002480	4014486493740
20	HYDRAULIC PUMP DRIVE	230380M1	1	1000541	4014486468236

MASSEY FERGUSON 550

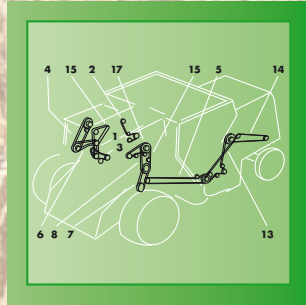
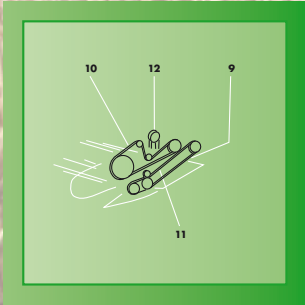

No.	Application	OEM - PN	Set	Optibelt AP-Nr.	EAN
	CHOPPER DRIVE	1051235M1	1	1000878	4014486473186
	STRAW CHOPPER CORN KIT - LOW SPEED	842935M1	1	1003482	4014486468182
1	CLEANING FAN - COUNTERSHAFT	227457M1	1	1000572	4014486468809
2	AUXILIARY CYLINDER (SLINGER)	834332M1	1	1000304	4014486465075
3	CLEANING FAN - HIGH SPEED	834492M2	1	1000211	4014486462593
3	CLEANING FAN DRIVE	227976M1	1	1000214	4014486462708
5	AUGER (GRAIN)	227984M1	1	1000731	4014486471250
6	HYDRAULIC PUMP DRIVE	843737M1	1	1000216	4014486462777
7	HYDROSTATIC DRIVE (LOWER)	834176M1	1	1003627	4014486488159
8	HYDROSTATIC DRIVE (UPPER)	834175M1	1	1001842	4014486488715
9	KNIFE WOBBLE - RIGID CUT BAR	834190M1	1	1000597	4014486469295
9	KNIFE WOBBLE - CENTERED CHAIN DRIVE	834058M1	1	1000598	4014486469301
9	KNIFE WOBBLE - FLOATING CUT BAR	833962M1	1	1000673	4014486470444
10	REEL DRIVE	834140M1	1	1000734	4014486471281
11	REEL DRIVE COUNTERSHAFT	834139M1	1	1000567	4014486468748
12	REEL DRIVE VARIABLE SPEED	833768M1	1	1001402	4014486459081
13	RETURN AUGER AND WALKER	227986M2	1	1000402	4014486466652
15	TANK UNLOADER DRIVE	228813M3	1	1000543	4014486468250
16	ALTERNATOR, FAN AND WATERPUMP DRIVE	532779M92	2	1002480	4014486493740

MASSEY FERGUSON 560

No.	Application	OEM - PN	Set	Optibelt AP-Nr.	EAN
1	FANNING MILL	3043154M1	1	1001398	4014486459043
1	FANNING MILL	3043153M1	1	1001399	4014486459050
2	TANK UNLOADER DRIVE	3370141M1	1	1001746	4014486487305
3	FANNING MILL (UPPER)	785585M3	1	1004096	4014486518696
5	HYDRAULIC PUMP DRIVE	843313M1	1	1001016	4014486497991
6	ALTERNATOR DRIVE	1687531M1	1	1002558	4014486495034
7	DRIVE	789967M1	1	1000986	4014486498066
8	MAIN BELT	789931M1	1	1002616	4014486498073
8	MAIN BELT	789930M1	1	1002617	4014486498080
10	RETURN DRIVE	795582M2	1	1000249	4014486463828
10	RETURN DRIVE	795514M4	1	1000264	4014486464214
11	SHAKER SHAFT DRIVE	1615254M1	1	1000765	4014486471687
12	ELEVATOR DRIVE GRAIN	784796M2	1	1003546	4014486471243
15	REDUCER	789853M1	1	1001403	4014486459098
16	KNIFE DRIVE	1724154M1	1	1000647	4014486470079
17	REEL DRIVE	843313M1	1	1001016	4014486497991

MASSEY FERGUSON 565



No.	Application	OEM - PN	Set	Optibelt AP-Nr.	EAN
1	FANNING MILL	3043154M1	1	1001398	4014486459043
1	FANNING MILL	3043153M1	1	1001399	4014486459050
2	TANK UNLOADER DRIVE	3370141M1	1	1001746	4014486487305
3	FANNING MILL (UPPER)	785585M3	1	1004096	4014486518696
5	HYDRAULIC PUMP DRIVE	843313M1	1	1001016	4014486497991
6	ALTERNATOR DRIVE	1687531M1	1	1002558	4014486495034
7	DRIVE	789967M1	1	1000986	4014486498066
8	MAIN BELT	789931M1	1	1002616	4014486498073
8	MAIN BELT	789930M1	1	1002617	4014486498080
10	RETURN DRIVE	795582M2	1	1000249	4014486463828
10	RETURN DRIVE	795514M4	1	1000264	4014486464214
11	SHAKER SHAFT DRIVE	1615254M1	1	1000765	4014486471687
12	ELEVATOR DRIVE GRAIN	784796M2	1	1003546	4014486471243
15	REDUCER	789853M1	1	1001403	4014486459098
16	KNIFE DRIVE	1724154M1	1	1000647	4014486470079
17	REEL DRIVE	843313M1	1	1001016	4014486497991

MASSEY FERGUSON 620

No.	Application	OEM - PN	Set	Optibelt AP-Nr.	EAN
1	FANNING MILL	1616477M1	1	1000211	4014486462593
1	FANNING MILL	784797M2	1	1000214	4014486462708
2	TANK UNLOADER DRIVE	619317M2	1	1000563	4014486468656
3	FANNING MILL (UPPER)	789853M1	1	1001403	4014486459098
3	FANNING MILL (UPPER)	785585M3	1	1004096	4014486518696
6	ALTERNATOR DRIVE	893575M1	1	1000060	4014486483802
7	DRIVE	789967M1	1	1000986	4014486498066
8	MAIN BELT	789930M1	1	1002617	4014486498080
9	MULTI FLOW	784170M2	1	1000425	4014486466881
10	RETURN DRIVE	795582M2	1	1000249	4014486463828
10	RETURN DRIVE	795514M4	1	1000264	4014486464214
11	SHAKER SHAFT DRIVE	1615254M1	1	1000765	4014486471687
12	ELEVATOR DRIVE GRAIN	784796M2	1	1003546	4014486471243
15	REDUCER	789853M1	1	1001403	4014486459098
16	KNIFE DRIVE	785585M3	1	1004096	4014486518696
17	REEL DRIVE	785810M1	1	1000378	4014486466416
17	REEL DRIVE	1615333M1	1	1000743	4014486471397

MASSEY FERGUSON 625



No.	Application	OEM - PN	Set	Optibelt AP-Nr.	EAN
1	FANNING MILL	1616477M1	1	1000211	4014486462593
1	FANNING MILL	784797M2	1	1000214	4014486462708
2	TANK UNLOADER DRIVE	619317M2	1	1000563	4014486468656
3	FANNING MILL (UPPER)	789853M1	1	1001403	4014486459098
3	FANNING MILL (UPPER)	785585M3	1	1004096	4014486518696
6	ALTERNATOR DRIVE	893575M1	1	1000060	4014486483802
7	DRIVE	789967M1	1	1000986	4014486498066
8	MAIN BELT	789930M1	1	1002617	4014486498080
9	MULTI FLOW	784170M2	1	1000425	4014486466881
10	RETURN DRIVE	795582M2	1	1000249	4014486463828
10	RETURN DRIVE	795514M4	1	1000264	4014486464214
11	SHAKER SHAFT DRIVE	1615254M1	1	1000765	4014486471687
12	ELEVATOR DRIVE GRAIN	784796M2	1	1003546	4014486471243
15	REDUCER	789853M1	1	1001403	4014486459098
16	KNIFE DRIVE	785585M3	1	1004096	4014486518696
17	REEL DRIVE	785810M1	1	1000378	4014486466416
17	REEL DRIVE	1615333M1	1	1000743	4014486471397

MASSEY FERGUSON 660

No.	Application	OEM - PN	Set	Optibelt AP-Nr.	EAN
1	FANNING MILL	3043154M1	1	1001398	4014486459043
1	FANNING MILL	3043153M1	1	1001399	4014486459050
2	TANK UNLOADER DRIVE	3370141M1	1	1001746	4014486487305
3	FANNING MILL (UPPER)	785585M3	1	1004096	4014486518696
5	HYDRAULIC PUMP DRIVE	843313M1	1	1001016	4014486497991
6	ALTERNATOR DRIVE	1687531M1	1	1002558	4014486495034
7	DRIVE	789967M1	1	1000986	4014486498066
8	MAIN BELT	789931M1	1	1002616	4014486498073
8	MAIN BELT	789930M1	1	1002617	4014486498080
10	RETURN DRIVE	795582M2	1	1000249	4014486463828
10	RETURN DRIVE	795514M4	1	1000264	4014486464214
11	SHAKER SHAFT DRIVE	1615254M1	1	1000765	4014486471687
12	ELEVATOR DRIVE GRAIN	784796M2	1	1003546	4014486471243
15	REDUCER	789853M1	1	1001403	4014486459098
16	KNIFE DRIVE	1724154M1	1	1000647	4014486470079
17	REEL DRIVE	843313M1	1	1001016	4014486497991

MASSEY FERGUSON 665



No.	Application	OEM - PN	Set	Optibelt AP-Nr.	EAN
1	FANNING MILL	3043154M1	1	1001398	4014486459043
1	FANNING MILL	3043153M1	1	1001399	4014486459050
2	TANK UNLOADER DRIVE	3370141M1	1	1001746	4014486487305
3	FANNING MILL (UPPER)	785585M3	1	1004096	4014486518696
5	HYDRAULIC PUMP DRIVE	843313M1	1	1001016	4014486497991
6	ALTERNATOR DRIVE	1687531M1	1	1002558	4014486495034
7	DRIVE	789967M1	1	1000986	4014486498066
8	MAIN BELT	789931M1	1	1002616	4014486498073
8	MAIN BELT	789930M1	1	1002617	4014486498080
10	RETURN DRIVE	795582M2	1	1000249	4014486463828
10	RETURN DRIVE	795514M4	1	1000264	4014486464214
11	SHAKER SHAFT DRIVE	1615254M1	1	1000765	4014486471687
12	ELEVATOR DRIVE GRAIN	784796M2	1	1003546	4014486471243
15	REDUCER	789853M1	1	1001403	4014486459098
16	KNIFE DRIVE	1724154M1	1	1000647	4014486470079
17	REEL DRIVE	843313M1	1	1001016	4014486497991

MASSEY FERGUSON 750

No.	Application	OEM - PN	Set	Optibelt AP-Nr.	EAN
1	HYDRAULIC PUMP DRIVE (MECHANICAL SERIAL NR. 5387 - ...)	222882M2	1	1000232	4014486463262
2	RADIATOR FAN (MECHANICAL SERIAL NR. 1979-5387)	259047M91	2	1000131	4014486461473
2	RADIATOR FAN DRIVE	265522M91	2	1000133	4014486461497
4	AIR CONDITIONING COMPRESSOR DRIVE (SERIAL NR. 9674 - ...)	834492M2	1	1000211	4014486462593
4	AIR CONDITIONING COMPRESSOR DRIVE	1686883M1	1	1002534	4014486494556
4	AIR CONDITIONING COMPRESSOR DRIVE (SERIAL NR. 9674 - ...)	843045M1	1	1002543	4014486494723
5	MAIN DRIVE	833874M1	1	1001848	4014486488791
7	RETURN ELEVATOR DRIVE	833854M2	1	1000335	4014486465754
8	CYLINDER	833868M2	1	1001483	4014486459937
10	STRAW CHOPPER (SERIAL NR. 16539 - ...)	843948M1	1	1001451	4014486459593
10	STRAW CHOPPER (SERIAL NR. ... - 16539)	833871M1	1	1001747	4014486485417
11	STRAW CHOPPER (SERIAL NR. 16539 - ...)	843747M1	1	1000827	4014486472547
12	STRAW CHOPPER DRIVE (SERIAL NR. 16539 - ...)	832906M1	1	1000758	4014486471595
12	STRAW CHOPPER DRIVE (SERIAL NR. ... - 16539)	833872M1	1	1000762	4014486471632
12	STRAW CHOPPER DRIVE	843760M1	1	1000803	4014486472233
14	STRAW WALKER DRIVE	833855M1	1	1000419	4014486466829
14	STRAW WALKER DRIVE	843310M1	1	1000429	4014486466935
15	SHAKER SHOE DRIVE	273757M91	2	1000381	4014486466447
16	SHAKER SHOE - COUNTERSHAFT - FAN (SERIAL NR. 15716 - ...)	281560M91	2	1002782	4014486464832
16	SHAKER SHOE - COUNTERSHAFT - FAN (SERIAL NR. ... - 15716)	274015M91	1	1003436	4014486464795
17	CLEANING FAN DRIVE	833863M1	1	1001400	4014486459067
20	REEL DRIVE	834140M1	1	1000734	4014486471281

MASSEY FERGUSON 750, 755



21	REEL DRIVE VARIABLE SPEED	833768M1	1	1001402	4014486459081
22	KNIFE WOBBLE DRIVE	834190M1	1	1000597	4014486469295
23	REEL DRIVE COUNTERSHAFT	834139M1	1	1000567	4014486468748
24	DISCHARGE DRIVE GRAIN TANK	833873M1	1	1001568	4014486484717
1	HYDRAULIC PUMP DRIVE (MECHANICAL SERIAL NR. 5387 - ...)	222882M2	1	1000232	4014486463262
2	RADIATOR FAN (MECHANICAL SERIAL NR. 1979-5387)	259047M91	2	1000131	4014486461473
2	RADIATOR FAN DRIVE	265522M91	2	1000133	4014486461497
4	AIR CONDITIONING COMPRESSOR DRIVE (SERIAL NR. 9674 - ...)	834492M2	1	1000211	4014486462593
4	AIR CONDITIONING COMPRESSOR DRIVE	1686883M1	1	1002534	4014486494556
4	AIR CONDITIONING COMPRESSOR DRIVE (SERIAL NR. 9674 - ...)	843045M1	1	1002543	4014486494723
5	MAIN DRIVE	833874M1	1	1001848	4014486488791
7	RETURN ELEVATOR DRIVE	833854M2	1	1000335	4014486465754
8	CYLINDER	833868M2	1	1001483	4014486459937
10	STRAW CHOPPER (SERIAL NR. 16539 - ...)	843948M1	1	1001451	4014486459593
10	STRAW CHOPPER (SERIAL NR. ... - 16539)	833871M1	1	1001747	4014486485417
11	STRAW CHOPPER (SERIAL NR. 16539 - ...)	843747M1	1	1000827	4014486472547
12	STRAW CHOPPER DRIVE (SERIAL NR. 16539 - ...)	832906M1	1	1000758	4014486471595
12	STRAW CHOPPER DRIVE (SERIAL NR. ... - 16539)	833872M1	1	1000762	4014486471632
12	STRAW CHOPPER DRIVE	843760M1	1	1000803	4014486472233
14	STRAW WALKER DRIVE	833855M1	1	1000419	4014486466829
14	STRAW WALKER DRIVE	843310M1	1	1000429	4014486466935

MASSEY FERGUSON 755



No.	Application	OEM - PN	Set	Optibelt AP-Nr.	EAN
15	SHAKER SHOE DRIVE	273757M91	2	1000381	4014486466447
16	SHAKER SHOE - COUNTERSHAFT - FAN (SERIAL NR. 15716 - ...)	281560M91	2	1002782	4014486464832
16	SHAKER SHOE - COUNTERSHAFT - FAN (SERIAL NR. ... - 15716)	274015M91	1	1003436	4014486464795
17	CLEANING FAN DRIVE	833863M1	1	1001400	4014486459067
20	REEL DRIVE	834140M1	1	1000734	4014486471281
21	REEL DRIVE VARIABLE SPEED	833768M1	1	1001402	4014486459081
22	KNIFE WOBBLE DRIVE	834190M1	1	1000597	4014486469295
23	REEL DRIVE COUNTERSHAFT	834139M1	1	1000567	4014486468748
24	DISCHARGE DRIVE GRAIN TANK	833873M1	1	1001568	4014486484717

MASSEY FERGUSON 760

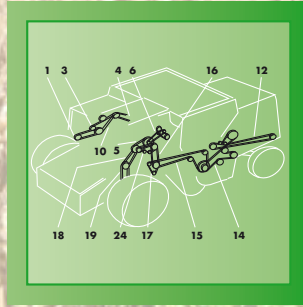
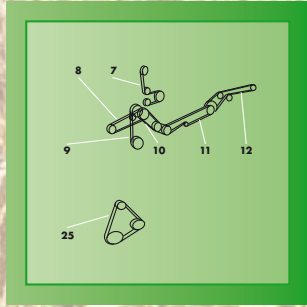
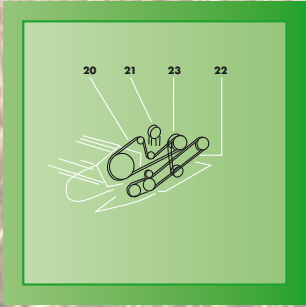

No.	Application	OEM - PN	Set	Optibelt AP-Nr.	EAN
1	REEL DRIVE	834139M1	1	1000567	4014486468748
2	SELECTOR	834058M1	1	1000598	4014486469301
3	REEL DRIVE	834140M1	1	1000734	4014486471281
5	ALTERNATOR DRIVE II	273837M91	1	1002490	4014486493931
7	AIR ASPIRATOR	833867M1	1	1000119	4014486461305
9	FAN DRIVE	274339M91	1	1000128	4014486461428
10	STRAW CUTTER	833871M1	1	1001747	4014486485417
11	CENTRAL TRANSMISSION	833865M1	1	1003665	4014486490879
12	AIR CONDITIONING COMPRESSOR DRIVE	834492M2	1	1000211	4014486462593
14	VENTILATOR	274015M91	1	1003436	4014486464795
15	ELEVATOR DRIVE UNIT	833854M2	1	1000335	4014486465754
16	BEATER DRIVE	273757M91	2	1000381	4014486466447
18	STRAW CUTTER	833872M1	1	1000762	4014486471632
19	STRAW SHAKER	833860M1	1	1000820	4014486472462
22	VENTILATOR	833863M1	1	1001400	4014486459067

MASSEY FERGUSON 850

No.	Application	OEM - PN	Set	Optibelt AP-Nr.	EAN
2	RADIATOR FAN DRIVE	265522M91	2	1000133	4014486461497
4	AIR CONDITIONING COMPRESSOR DRIVE	521110M1	1	1002531	4014486494501
4	AIR CONDITIONING COMPRESSOR DRIVE (SERIAL NR. ... - 25658)	529964M1	1	1002534	4014486494556
4	AIR CONDITIONING COMPRESSOR DRIVE	3386214M1	1	1002539	4014486494648
5	MAIN DRIVE - 3 BAND	833874M1	1	1001848	4014486488791
7	RETURN ELEVATOR DRIVE	833854M2	1	1000335	4014486465754
8	CYLINDER DRIVE	833868M2	1	1001483	4014486459937
10	STRAW CHOPPER (FRONT)	843948M1	1	1001451	4014486459593
11	STRAW CHOPPER (CENTER)	843747M1	1	1000827	4014486472547
12	STRAW CHOPPER (REAR)	843760M1	1	1000803	4014486472233
14	STRAW WALKER DRIVE	843310M1	1	1000429	4014486466935
15	SHAKER SHOE DRIVE	273757M91	2	1000381	4014486466447
17	CLEANING FAN DRIVE	833863M1	1	1001400	4014486459067
21	TANK UNLOADER DRIVE	833873M1	1	1001568	4014486484717
23	WOBBLE BOX - RIGID CUT BAR 15 FEET - 20 FEET TABLE	834190M1	1	1000597	4014486469295
23	WOBBLE BOX - FLOATING CUT BAR 15 FEET - 20 FEET	833962M1	1	1000673	4014486470444
23	WOBBLE BOX - FLOATING CUT BAR 22 FEET	227455M1	1	1000698	4014486470802
24	REEL DRIVE	834140M1	1	1000734	4014486471281
25	REEL DRIVE COUNTERSHAFT	834139M1	1	1000567	4014486468748
26	REEL DRIVE VARIABLE SPEED	833768M1	1	1001402	4014486459081

MASSEY FERGUSON 855



BISO - Schrattecker
BIZON
CASE INTL. HARVESTER
CLAAS
DEUTZ-FAHR
DRONNING-BORG
FENDT
FORTSCHRITT
JOHN DEERE
KRONE
LAVERDA
MASSEY FERGUSON
ROSTSELMASH
NEW HOLLAND

No.	Application	OEM - PN	Set	Optibelt AP-Nr.	EAN
2	RADIATOR FAN DRIVE	265522M91	2	1000133	4014486461497
4	AIR CONDITIONING COMPRESSOR DRIVE	521110M1	1	1002531	4014486494501
4	AIR CONDITIONING COMPRESSOR DRIVE (SERIAL NR. ... - 25658)	529964M1	1	1002534	4014486494556
4	AIR CONDITIONING COMPRESSOR DRIVE	3386214M1	1	1002539	4014486494648
5	MAIN DRIVE - 3 BAND	833874M1	1	1001848	4014486488791
7	RETURN ELEVATOR DRIVE	833854M2	1	1000335	4014486465754
8	CYLINDER DRIVE	833868M2	1	1001483	4014486459937
10	STRAW CHOPPER (FRONT)	843948M1	1	1001451	4014486459593
11	STRAW CHOPPER (CENTER)	843747M1	1	1000827	4014486472547
12	STRAW CHOPPER (REAR)	843760M1	1	1000803	4014486472233
14	STRAW WALKER DRIVE	843310M1	1	1000429	4014486466935
15	SHAKER SHOE DRIVE	273757M91	2	1000381	4014486466447
17	CLEANING FAN DRIVE	833863M1	1	1001400	4014486459067
21	TANK UNLOADER DRIVE	833873M1	1	1001568	4014486484717
23	WOBBLE BOX - RIGID CUT BAR 15 FEET - 20 FEET TABLE	834190M1	1	1000597	4014486469295
23	WOBBLE BOX - FLOATING CUT BAR 15 FEET - 20 FEET	833962M1	1	1000673	4014486470444
23	WOBBLE BOX - FLOATING CUT BAR 22 FEET	227455M1	1	1000698	4014486470802
24	REEL DRIVE	834140M1	1	1000734	4014486471281
25	REEL DRIVE COUNTERSHAFT	834139M1	1	1000567	4014486468748
26	REEL DRIVE VARIABLE SPEED	833768M1	1	1001402	4014486459081

MASSEY FERGUSON 860

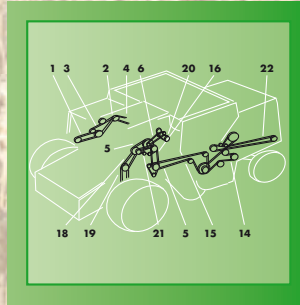
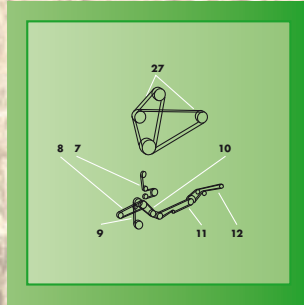
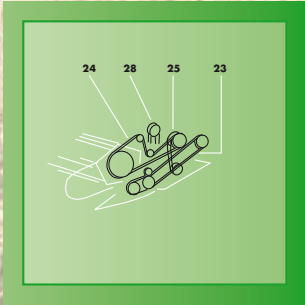

No.	Application	OEM - PN	Set	Optibelt AP-Nr.	EAN
2	RADIATOR AND FAN DRIVE (SERIAL NR. ... - 16559)	259047M91	2	1000131	4014486461473
2	RADIATOR AND FAN DRIVE (SERIAL NR. 15558 - ...)	284633M91	2	1003757	4014486461459
4	AIR CONDITIONING COMPRESSOR DRIVE	529964M1	1	1002534	4014486494556
5	MAIN DRIVE	833865M1	1	1003665	4014486490879
6	ROTARY SCREEN - COUNTERSHAFT	833867M1	1	1000119	4014486461305
7	RETURN ELEVATOR DRIVE	833854M2	1	1000335	4014486465754
10	STRAW CHOPPER (FRONT)	843948M1	1	1001451	4014486459593
11	STRAW CHOPPER (CENTER)	843747M1	1	1000827	4014486472547
12	STRAW CHOPPER (REAR) 102.5 INCH	843760M1	1	1000803	4014486472233
15	SHAKER SHOE DRIVE	273757M91	2	1000381	4014486466447
17	CLEANING FAN DRIVE	833863M1	1	1001400	4014486459067
20	COUNTERSHAFT - ROTARY SCREEN	844306M1	1	1000116	4014486461251
21	TANK UNLOADER DRIVE	833862M3	1	1003597	4014486485059
22	WOBBLE BOX - FLOATING CUT BAR 15 FEET - 20 FEET	833962M1	1	1000673	4014486470444
22	WOBBLE BOX - FLOATING CUT BAR 22 FEET	832832M1	1	1000688	4014486470680
22	WOBBLE BOX - FLOATING CUT BAR 22 FEET	227455M1	1	1000698	4014486470802
23	WOBBLE BOX DRIVE	834190M1	1	1000597	4014486469295
24	REEL DRIVE	834140M1	1	1000734	4014486471281
25	REEL DRIVE COUNTERSHAFT	834139M1	1	1000567	4014486468748

MASSEY FERGUSON 865

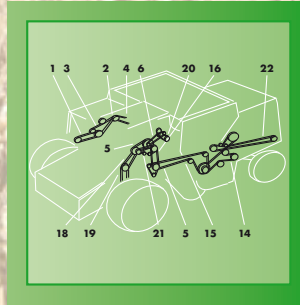
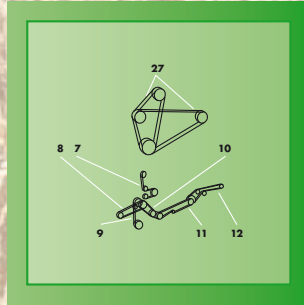
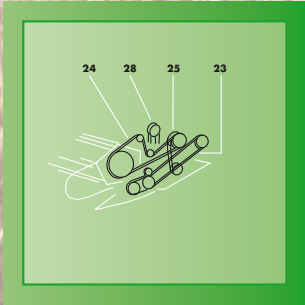

No.	Application	OEM - PN	Set	Optibelt AP-Nr.	EAN
2	RADIATOR AND FAN DRIVE (SERIAL NR. ... - 16559)	259047M91	2	1000131	4014486461473
2	RADIATOR AND FAN DRIVE (SERIAL NR. 15558 - ...)	284633M91	2	1003757	4014486461459
4	AIR CONDITIONING COMPRESSOR DRIVE	529964M1	1	1002534	4014486494556
5	MAIN DRIVE	833865M1	1	1003665	4014486490879
6	ROTARY SCREEN - COUNTERSHAFT	833867M1	1	1000119	4014486461305
7	RETURN ELEVATOR DRIVE	833854M2	1	1000335	4014486465754
10	STRAW CHOPPER (FRONT)	843948M1	1	1001451	4014486459593
11	STRAW CHOPPER (CENTER)	843747M1	1	1000827	4014486472547
12	STRAW CHOPPER (REAR) 102.5 INCH	843760M1	1	1000803	4014486472233
15	SHAKER SHOE DRIVE	273757M91	2	1000381	4014486466447
17	CLEANING FAN DRIVE	833863M1	1	1001400	4014486459067
20	COUNTERSHAFT - ROTARY SCREEN	844306M1	1	1000116	4014486461251
21	TANK UNLOADER DRIVE	833862M3	1	1003597	4014486485059
22	WOBBLE BOX - FLOATING CUT BAR 15 FEET - 20 FEET	833962M1	1	1000673	4014486470444
22	WOBBLE BOX - FLOATING CUT BAR 22 FEET	832832M1	1	1000688	4014486470680
22	WOBBLE BOX - FLOATING CUT BAR 22 FEET	227455M1	1	1000698	4014486470802
23	WOBBLE BOX DRIVE	834190M1	1	1000597	4014486469295
24	REEL DRIVE	834140M1	1	1000734	4014486471281
25	REEL DRIVE COUNTERSHAFT	834139M1	1	1000567	4014486468748

MASSEY FERGUSON 3640, 8560

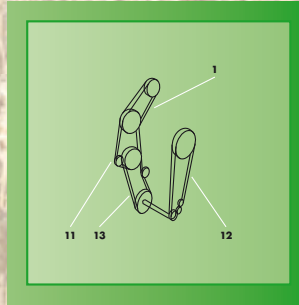
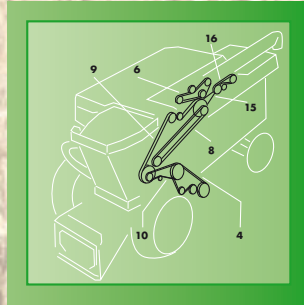
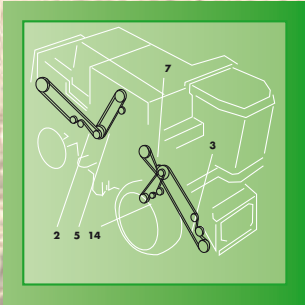

No.	Application	OEM - PN	Set	Optibelt AP-Nr.	EAN
11	USED WITH THE A6.354.4 ENGINE	2834466M1	1	1003399	4014486462937
19	USED WITH THE A6.358 ENGINE	487802M2	1	1002550	4014486494822
19	USED WITH THE A6.354.4 ENGINE	3145238M1	1	1002584	4014486495706
4	ELEVATOR DRIVE GRAIN	227455M1	1	1000698	4014486470802
5	JACKSHAFT - SPREADER	227455M1	1	1000698	4014486470802
8	UNLOADING DRIVE	101102M1	1	1001662	4014486486186
10	SHAKER SHOE PITMAN DRIVE	2593000W1	1	1001604	4014486485295

MASSEY FERGUSON 8570, 8780

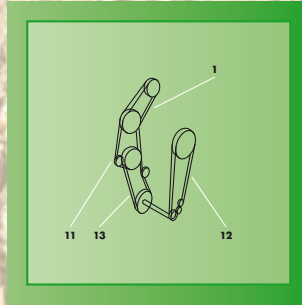
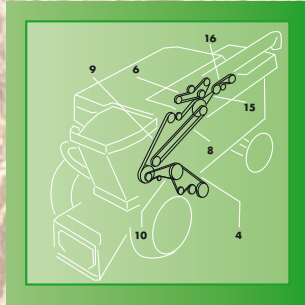
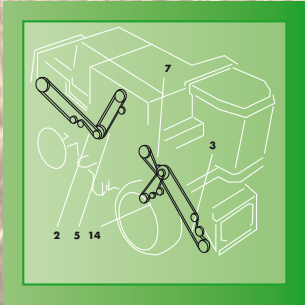

No.	Application	OEM - PN	Set	Optibelt AP-Nr.	EAN
2	SPREADER DRIVE	1680230W1	1	1004118	4014486522921
3	FEEDER DRIVE HIGH CAPACITY (4 RIB)	104072W1	1	1001171	4014486491821
4	ELEVATOR DRIVE GRAIN	227455M1	1	1000698	4014486470802
5	CHOPPER DRIVE - JACKSHAFT	103319M1	1	1000692	4014486470710
5	SPREADER JACKSHAFT DRIVE	227455M1	1	1000698	4014486470802
8	UNLOADING DRIVE	101102M1	1	1001662	4014486486186
10	SHAKER SHOE PITMAN DRIVE	2593000W1	1	1001604	4014486485295
1	FEEDER DRIVE	71379105	1	1001170	4014486491814
4	ELEVATOR DRIVE UNIT	71385801	1	1003628	4014486519013
6	CHOPPER DRIVE - 2ND STAGE	71388712	1	1000821	4014486472479
7	AUGER DRIVE	1680230W1	1	1004118	4014486522921
8	REEL DRIVE	227455M1	1	1000698	4014486470802
9	JACKSHAFT DRIVE	103319M1	1	1000692	4014486470710
11	UNLOADING DRIVE	101102M1	1	1001662	4014486486186
13	REEL DRIVE	227455M1	1	1000698	4014486470802
14	PITMAN DRIVE	2593000W1	1	1001604	4014486485295
16	BEATER DRIVE	71386352	1	1001900	4014486489606
18	MAIN COUNTERSHAFT DRIVE	71385693	1	1003357	4014486488951
19	MAIN COUNTERSHAFT DRIVE	71387775	1	1003643	4014486489156
21	HYDRAULIC PUMP ROTOR DRIVE	111954W1	1	1001166	4014486491777
23	FAN DRIVE	71148120	1	1002556	4014486494983

MASSEY FERGUSON 9720, 186 (F)



No.	Application	OEM - PN	Set	Optibelt AP-Nr.	EAN
11	HYDROSTATIC PUMP DRIVE	31-2449520	1	1001948	4014486490527
1	TABLE FEEDER DRUM	1724154M1	1	1000647	4014486470079
1	TABLE FEEDER DRUM	417974M1	1	1000651	4014486470116
2	TANK UNLOADER DRIVE	621259M1	1	1000547	4014486468311
3	FANNING MILL (UPPER)	621261M1	1	1000284	4014486464641
7	STRAW WALKER SHAKER	621258M1	1	1000346	4014486465983
9	TRACTION (LOWER)	905920M1	1	1001450	4014486459586
10	REDUCER	417972M1	1	1000885	4014486473261
12	KNIFE DRIVE	1722835M1	1	1003502	4014486469097
12	KNIFE DRIVE	402607M1	1	1003515	4014486469653
15	FANNING MILL	621262M1	1	1003334	4014486462586

MASSEY FERGUSON 186 OLD, 206 OLD



BISO - Schrattecker
BIZON
CASE INTL. HARVESTER
CLAAS
DEUTZ-FAHR
DRONNING-BORG
FENDT
FORTSCHRITT
JOHN DEERE
KRONE
LAVERDA
MASSEY FERGUSON
NEW HOLLAND
ROSTSELMASH

No.	Application	OEM - PN	Set	Optibelt AP-Nr.	EAN
	RADIATOR FAN DRIVE	893575M1	1	1000060	4014486483802
6	KNIFE DRIVE (UPPER)	417972M1	1	1000885	4014486473261
7	FEEDER DRIVE	1724154M1	1	1000647	4014486470079
7	FEEDER DRIVE	417974M1	1	1000651	4014486470116
8	KNIFE DRIVE	402607M1	1	1003515	4014486469653
10	TANK UNLOADER DRIVE	621259M1	1	1000547	4014486468311
12	HYDRAULIC PUMP DRIVE	417468M1	1	1003397	4014486462821
1	SHAKER SHOE DRIVE	621258M1	1	1000346	4014486465983
2	BEATER - FAN (REAR)	621261M1	1	1000284	4014486464641
3	FANNING MILL	621262M1	1	1003334	4014486462586
4	DRUM DRIVE VARIABLE SPEED	905920M1	1	1001450	4014486459586
6	KNIFE DRIVE (UPPER)	417972M1	1	1000885	4014486473261
7	FEEDER DRIVE	1724154M1	1	1000647	4014486470079
8	KNIFE DRIVE	402607M1	1	1003515	4014486469653
9	KNIFE DRIVE	1722835M1	1	1003502	4014486469097

MASSEY FERGUSON 307 OLD, 400 - 500



No.	Application	OEM - PN	Set	Optibelt AP-Nr.	EAN
2	KNIFE DRIVE (UPPER)	417972M1	1	1000885	4014486473261
3	TRACTION VARIATOR DRIVE	905920M1	1	1001450	4014486459586
5	SHAKER SHOE DRIVE	621258M1	1	1000346	4014486465983
7	KNIFE DRIVE	1722835M1	1	1003502	4014486469097
7	KNIFE DRIVE	402607M1	1	1003515	4014486469653
9	BEATER - FAN (REAR)	621261M1	1	1000284	4014486464641
11	FEEDER DRIVE	1724154M1	1	1000647	4014486470079
12	FAN CLEANING	621262M1	1	1003334	4014486462586
1	RADIATOR FAN DRIVE	228722M1	1	1000214	4014486462708
2	RADIATOR FAN DRIVE	233950M1	1	1003334	4014486462586
3	HYDRAULIC PUMP DRIVE	832490M1	1	1001277	4014486474435
4	VENTILATOR	227976M1	1	1000214	4014486462708
6	BEATER DRIVE	832538M1	1	1003431	4014486464313
9	COUNTERSHAFT DRIVE	227457M1	1	1000572	4014486468809
10	HOPPER	227984M1	1	1000731	4014486471250

MASSEY FERGUSON 400 - 500 OLD, 410 - 415



BISO - Schrattecker
BIZON
CASE INTL. HARVESTER
CLAAS
DEUTZ-FAHR
DRONNING-BORG
FENDT
FORTSCHRITT
JOHN DEERE
KRONE
LAVERDA
MASSEY FERGUSON
ROSTSELMASH
NEW HOLLAND

No.	Application	OEM - PN	Set	Optibelt AP-Nr.	EAN
2	COUNTERSHAFT - REEL DRIVE	1855008M1	1	1000572	4014486468809
6	REEL DRIVE	785810M1	1	1000378	4014486466416
8	RETURN ELEVATOR DRIVE	832538M1	1	1003431	4014486464313
9	RADIATOR AIR INTAKE	228722M1	1	1000214	4014486462708
10	STRAW WALKER DRIVE	1615254M1	1	1000765	4014486471687
10	STRAW WALKER DRIVE	320593M2	1	1001361	4014486474756
15	HYDRAULIC PUMP DRIVE	832490M1	1	1001277	4014486474435
16	RADIATOR FAN DRIVE	233950M1	1	1003334	4014486462586
1	FANNING MILL	784797M2	1	1000214	4014486462708
3	FANNING MILL (UPPER)	1855008M1	1	1000572	4014486468809
5	HYDRAULIC PUMP DRIVE	832490M1	1	1001277	4014486474435
6	ALTERNATOR DRIVE	893575M1	1	1000060	4014486483802
10	RETURN DRIVE	795582M2	1	1000249	4014486463828
10	RETURN DRIVE	795514M4	1	1000264	4014486464214
11	SHAKER SHAFT DRIVE	1615254M1	1	1000765	4014486471687
12	ELEVATOR DRIVE GRAIN	784796M2	1	1003546	4014486471243
16	KNIFE DRIVE	785585M3	1	1004096	4014486518696
17	REEL DRIVE	1615333M1	1	1000743	4014486471397
17	REEL DRIVE	1615254M1	1	1000765	4014486471687

MASSEY FERGUSON 410 - 415 -510 - 515 OLD, 410 - 510



No.	Application	OEM - PN	Set	Optibelt AP-Nr.	EAN
2	COUNTERSHAFT - REEL DRIVE	1855008M1	1	1000572	4014486468809
6	REEL DRIVE	1615333M1	1	1000743	4014486471397
8	RETURN ELEVATOR DRIVE	795514M4	1	1000264	4014486464214
9	RADIATOR AIR INTAKE	228722M1	1	1000214	4014486462708
10	STRAW WALKER DRIVE	1615254M1	1	1000765	4014486471687
15	HYDRAULIC PUMP DRIVE	832490M1	1	1001277	4014486474435
16	RADIATOR FAN DRIVE	233950M1	1	1003334	4014486462586
17	KNIFE DRIVE	785585M3	1	1004096	4014486518696
1	ENGINE FAN DRIVE	240575M2	1	1002298	4014486479867
2	HYDRAULIC PUMP DRIVE	832490M1	1	1001277	4014486474435
3	AIR FILTER	228722M1	1	1000214	4014486462708
4	VENTILATOR	227976M1	1	1000214	4014486462708
6	HYDRAULIC PUMP DRIVE	230381M1	1	1003482	4014486468182
8	VENTILATOR	227457M1	1	1000572	4014486468809
9	HOPPER	227984M1	1	1000731	4014486471250
10	REEL DRIVE	1615333M1	1	1000743	4014486471397

MASSEY FERGUSON 487 - 506 - 507, 487 OLD



No.	Application	OEM - PN	Set	Optibelt AP-Nr.	EAN
1	TABLE FEEDER DRUM	621588M1	1	1000668	4014486470352
2	TANK UNLOADER DRIVE	905980M1	1	1001552	4014486484519
3	FANNING MILL (UPPER)	621261M1	1	1000284	4014486464641
5	BEATER DRIVE	1720255M1	1	1001871	4014486489125
7	STRAW WALKER SHAKER	621258M1	1	1000346	4014486465983
10	REDUCER	417972M1	1	1000885	4014486473261
12	KNIFE DRIVE	410959M1	1	1003512	4014486469516
12	KNIFE DRIVE	402607M1	1	1003515	4014486469653
15	FANNING MILL	621262M1	1	1003334	4014486462586
1	SHAKER SHOE DRIVE	621258M1	1	1000346	4014486465983
2	BEATER - FAN (REAR)	621261M1	1	1000284	4014486464641
6	KNIFE DRIVE (UPPER)	417972M1	1	1000885	4014486473261
7	FEEDER DRIVE	1720488M1	1	1000675	4014486470475
8	KNIFE DRIVE	402607M1	1	1003515	4014486469653
9	FEEDER AUGER	1722835M1	1	1003502	4014486469097
10	TANK UNLOADER DRIVE	621259M1	1	1000547	4014486468311
11	BEATER (REAR)	1720255M1	1	1001871	4014486489125
13	HYDRAULIC PUMP DRIVE	1720674M2	1	1000220	4014486462838

MASSEY FERGUSON 506 OLD, 507 OLD, 520 - 525

No.	Application	OEM - PN	Set	Optibelt AP-Nr.	EAN
1	SHAKER SHOE DRIVE	621258M1	1	1000346	4014486465983
2	BEATER - FAN (REAR)	621261M1	1	1000284	4014486464641
3	FANNING MILL	621262M1	1	1003334	4014486462586
6	KNIFE DRIVE (UPPER)	417972M1	1	1000885	4014486473261
7	FEEDER DRIVE	621588M1	1	1000668	4014486470352
8	KNIFE DRIVE	402607M1	1	1003515	4014486469653
9	FEEDER AUGER	410959M1	1	1003512	4014486469516
10	TANK UNLOADER DRIVE	905980M1	1	1001552	4014486484519
11	BEATER (REAR)	1720255M1	1	1001871	4014486489125
1	SHAKER SHOE DRIVE	621258M1	1	1000346	4014486465983
4	BEATER (REAR)	1720205M3	1	1001889	4014486489460
6	BEATER (REAR)	621261M1	1	1000284	4014486464641
7	FANNING MILL	621262M1	1	1003334	4014486462586
8	FEEDER DRIVE	621588M1	1	1000668	4014486470352
9	TANK UNLOADER DRIVE	905980M1	1	1001552	4014486484519
10	HYDRAULIC PUMP DRIVE	1720674M2	1	1000220	4014486462838
13	KNIFE DRIVE	410959M1	1	1003512	4014486469516
2	DRUM DRIVE	912877M1	1	1001181	4014486490190
3	DRIVE RIGHT SIDE	227976M1	1	1000214	4014486462708
7	THRESHING DRIVE	619327M1	1	1004086	4014486520392

MASSEY FERGUSON 520 - 525, 520 OLD



No.	Application	OEM - PN	Set	Optibelt AP-Nr.	EAN
8	HYDRAULIC PUMP DRIVE	619595M1	1	1000536	4014486468168
12	AUGER DRIVE	227984M1	1	1000731	4014486471250
15	REEL DRIVE VARIABLE SPEED	789853M1	1	1001403	4014486459098
1	TANK UNLOADER DRIVE	619317M2	1	1000563	4014486468656
3	HYDRAULIC PUMP DRIVE	782850M2	1	1000537	4014486468175
5	CASCADE SEPARATOR	784170M2	1	1000425	4014486466881
6	COUNTERSHAFT 2ND STAGE - GRAIN AUGER	784796M2	1	1003546	4014486471243
7	COUNTERSHAFT - FAN - 2ND STAGE	784797M2	1	1000214	4014486462708
8	KNIFE DRIVE	785585M3	1	1004096	4014486518696
9	COUNTERSHAFT DRIVE - 2ND STAGE	785585M3	1	1004096	4014486518696
10	REEL DRIVE VARIABLE SPEED	789853M1	1	1001403	4014486459098
11	REEL DRIVE	785810M1	1	1000378	4014486466416
11	PICK UP REEL	1615333M1	1	1000743	4014486471397
12	BEATER (REAR)	789967M1	1	1000986	4014486498066
13	RETURN ELEVATOR DRIVE	795582M2	1	1000249	4014486463828
13	RETURN ELEVATOR DRIVE	795514M4	1	1000264	4014486464214
14	STRAW WALKER DRIVE	1615254M1	1	1000765	4014486471687
17	MAIN DRIVE	789931M1	1	1002616	4014486498073
17	MAIN DRIVE	789930M1	1	1002617	4014486498080

MASSEY FERGUSON 525 OLD

No.	Application	OEM - PN	Set	Optibelt AP-Nr.	EAN
1	TANK UNLOADER DRIVE	619317M2	1	1000563	4014486468656
3	HYDRAULIC PUMP DRIVE	782850M2	1	1000537	4014486468175
5	CASCADE SEPARATOR	784170M2	1	1000425	4014486466881
6	COUNTERSHAFT 2ND STAGE - GRAIN AUGER	784796M2	1	1003546	4014486471243
7	COUNTERSHAFT - FAN - 2ND STAGE	784797M2	1	1000214	4014486462708
8	KNIFE DRIVE	785585M3	1	1004096	4014486518696
9	COUNTERSHAFT DRIVE - 2ND STAGE	785585M3	1	1004096	4014486518696
10	REEL DRIVE VARIABLE SPEED	789853M1	1	1001403	4014486459098
11	REEL DRIVE	785810M1	1	1000378	4014486466416
11	PICK UP REEL	1615333M1	1	1000743	4014486471397
12	BEATER (REAR)	789967M1	1	1000986	4014486498066
13	RETURN ELEVATOR DRIVE	795582M2	1	1000249	4014486463828
13	RETURN ELEVATOR DRIVE	795514M4	1	1000264	4014486464214
14	STRAW WALKER DRIVE	1615254M1	1	1000765	4014486471687
17	MAIN DRIVE	789931M1	1	1002616	4014486498073
17	MAIN DRIVE	789930M1	1	1002617	4014486498080

MASSEY FERGUSON 530 S, 620 - 625



BISO - Schrattecker
BIZON
CASE INTL. HARVESTER
CLAAS
DEUTZ-FAHR
DRONNING-BORG
FENDT
FORTSCHRITT
JOHN DEERE
KRONE
LAVERDA
MASSEY FERGUSON
NEW HOLLAND
ROTSSELMASH

No.	Application	OEM - PN	Set	Optibelt AP-Nr.	EAN
1	FANNING MILL	3043154M1	1	1001398	4014486459043
1	FANNING MILL	3043153M1	1	1001399	4014486459050
2	TANK UNLOADER DRIVE	3370141M1	1	1001746	4014486487305
3	FANNING MILL (UPPER)	785585M3	1	1004096	4014486518696
5	HYDRAULIC PUMP DRIVE	843313M1	1	1001016	4014486497991
6	ALTERNATOR DRIVE	1687531M1	1	1002558	4014486495034
7	DRIVE	789967M1	1	1000986	4014486498066
8	MAIN BELT	789931M1	1	1002616	4014486498073
8	MAIN BELT	789930M1	1	1002617	4014486498080
10	RETURN DRIVE	795582M2	1	1000249	4014486463828
10	RETURN DRIVE	795514M4	1	1000264	4014486464214
11	SHAKER SHAFT DRIVE	1615254M1	1	1000765	4014486471687
12	ELEVATOR DRIVE GRAIN	784796M2	1	1003546	4014486471243
15	REDUCER	789853M1	1	1001403	4014486459098
16	KNIFE DRIVE	1724154M1	1	1000647	4014486470079
17	REEL DRIVE	843313M1	1	1001016	4014486497991
4	REEL DRIVE	785810M1	1	1000378	4014486466416
9	REEL DRIVE	1615333M1	1	1000743	4014486471397
11	REEL DRIVE VARIABLE SPEED	789853M1	1	1001403	4014486459098
12	THRESHING DRIVE	789931M1	1	1002616	4014486498073
13	DRUM DRIVE	789967M1	1	1000986	4014486498066

MASSEY FERGUSON 620 OLD

No.	Application	OEM - PN	Set	Optibelt AP-Nr.	EAN
1	TANK UNLOADER DRIVE	619317M2	1	1000563	4014486468656
3	HYDRAULIC PUMP DRIVE	782850M2	1	1000537	4014486468175
5	CASCADE SEPARATOR	784170M2	1	1000425	4014486466881
6	COUNTERSHAFT 2ND STAGE - GRAIN AUGER	784796M2	1	1003546	4014486471243
7	COUNTERSHAFT - FAN - 2ND STAGE	784797M2	1	1000214	4014486462708
8	KNIFE DRIVE	785585M3	1	1004096	4014486518696
9	COUNTERSHAFT DRIVE - 2ND STAGE	785585M3	1	1004096	4014486518696
10	REEL DRIVE VARIABLE SPEED	789853M1	1	1001403	4014486459098
11	REEL DRIVE	785810M1	1	1000378	4014486466416
11	PICK UP REEL	1615333M1	1	1000743	4014486471397
12	BEATER (REAR)	789967M1	1	1000986	4014486498066
13	RETURN ELEVATOR DRIVE	795582M2	1	1000249	4014486463828
13	RETURN ELEVATOR DRIVE	795514M4	1	1000264	4014486464214
14	STRAW WALKER DRIVE	1615254M1	1	1000765	4014486471687
17	MAIN DRIVE	789931M1	1	1002616	4014486498073
17	MAIN DRIVE	789930M1	1	1002617	4014486498080

MASSEY FERGUSON 625 OLD



No.	Application	OEM - PN	Set	Optibelt AP-Nr.	EAN
1	TANK UNLOADER DRIVE	619317M2	1	1000563	4014486468656
3	HYDRAULIC PUMP DRIVE	782850M2	1	1000537	4014486468175
5	CASCADE SEPARATOR	784170M2	1	1000425	4014486466881
6	COUNTERSHAFT 2ND STAGE - GRAIN AUGER	784796M2	1	1003546	4014486471243
7	COUNTERSHAFT - FAN - 2ND STAGE	784797M2	1	1000214	4014486462708
8	KNIFE DRIVE	785585M3	1	1004096	4014486518696
9	COUNTERSHAFT DRIVE - 2ND STAGE	785585M3	1	1004096	4014486518696
10	REEL DRIVE VARIABLE SPEED	789853M1	1	1001403	4014486459098
11	REEL DRIVE	785810M1	1	1000378	4014486466416
11	PICK UP REEL	1615333M1	1	1000743	4014486471397
12	BEATER (REAR)	789967M1	1	1000986	4014486498066
13	RETURN ELEVATOR DRIVE	795582M2	1	1000249	4014486463828
13	RETURN ELEVATOR DRIVE	795514M4	1	1000264	4014486464214
14	STRAW WALKER DRIVE	1615254M1	1	1000765	4014486471687
17	MAIN DRIVE	789931M1	1	1002616	4014486498073
17	MAIN DRIVE	789930M1	1	1002617	4014486498080

MASSEY FERGUSON 630 OLD, 630 S OLD



No.	Application	OEM - PN	Set	Optibelt AP-Nr.	EAN
1	TANK UNLOADER DRIVE	324872M1	1	1000215	4014486462739
4	TABLE DRIVE	320595M2	1	1000540	4014486468229
4	TABLE DRIVE	322768M1	1	1003482	4014486468182
6	KNIFE DRIVE	320623M2	1	1003438	4014486464894
7	FEEDER AUGER	320596M1	1	1003412	4014486463545
8	TRACTION VARIATOR DRIVE	320551M1	1	1001063	4014486496475
9	HYDRAULIC PUMP DRIVE	410195M1	1	1002281	4014486478495
10	STRAW WALKER DRIVE	320593M2	1	1001361	4014486474756
1	TANK UNLOADER DRIVE	324872M1	1	1000215	4014486462739
4	TABLE DRIVE	320595M2	1	1000540	4014486468229
4	TABLE DRIVE	322768M1	1	1003482	4014486468182
6	KNIFE DRIVE	320623M2	1	1003438	4014486464894
7	FEEDER AUGER	320596M1	1	1003412	4014486463545
8	TRACTION VARIATOR DRIVE	320551M1	1	1001063	4014486496475
9	HYDRAULIC PUMP DRIVE	410195M1	1	1002281	4014486478495
10	STRAW WALKER DRIVE	320593M2	1	1001361	4014486474756

MASSEY FERGUSON 685 OLD, 685 S OLD



No.	Application	OEM - PN	Set	Optibelt AP-Nr.	EAN
1	KNIFE DRIVE	402607M1	1	1003515	4014486469653
2	TRACTION VARIATOR DRIVE	401110M1	1	1001160	4014486497397
7	HYDRAULIC PUMP DRIVE (PERKINS)	403041M1	1	1000206	4014486462463
9	TANK UNLOADER DRIVE	403071M1	1	1003432	4014486464337
10	STRAW BALER	328656M1	1	1000527	4014486468076
11	FANNING MILL	402604M1	1	1003390	4014486462579
12	FANNING MILL	402605M1	1	1003428	4014486464238
13	BEATER (REAR)	402606M1	1	1003523	4014486469936
1	KNIFE DRIVE	402607M1	1	1003515	4014486469653
2	TRACTION VARIATOR DRIVE	401110M1	1	1001160	4014486497397
7	HYDRAULIC PUMP DRIVE (PERKINS)	403041M1	1	1000206	4014486462463
9	TANK UNLOADER DRIVE	403071M1	1	1003432	4014486464337
10	STRAW BALER	328656M1	1	1000527	4014486468076
11	FANNING MILL	402604M1	1	1003390	4014486462579
12	FANNING MILL	402605M1	1	1003428	4014486464238
13	BEATER (REAR)	402606M1	1	1003523	4014486469936

MASSEY FERGUSON 750 OLD

No.	Application	OEM - PN	Set	Optibelt AP-Nr.	EAN
1		834140M1	1	1000734	4014486471281
2	REEL DRIVE VARIABLE SPEED	833768M1	1	1001402	4014486459081
3	REEL DRIVE	834139M1	1	1000567	4014486468748
4	WOBBLE BOX DRIVE	834058M1	1	1000598	4014486469301
7	TRACTION DRIVE	833874M1	1	1001848	4014486488791
9	DISCHARGE DRIVE GRAIN TANK	833873M1	1	1001568	4014486484717
12	STRAW WALKER DRIVE	833855M1	1	1000419	4014486466829
12	STRAW WALKER DRIVE	843310M1	1	1000429	4014486466935
16	HYDRAULIC PUMP DRIVE	222882M2	1	1000232	4014486463262
17	RADIATOR FAN DRIVE	273837M91	1	1002490	4014486493931
18	ALTERNATOR DRIVE (DIESEL ENGINE)	259047M91	2	1000131	4014486461473
19	AIR CONDITIONING COMPRESSOR DRIVE	834492M2	1	1000211	4014486462593
19	AIR CONDITIONING COMPRESSOR DRIVE	843045M1	1	1002543	4014486494723
22	STRAW CHOPPER DRIVE	833871M1	1	1001747	4014486485417
24	STRAW CHOPPER DRIVE	833872M1	1	1000762	4014486471632
24	STRAW CHOPPER DRIVE	843324M1	1	1000804	4014486472240
25	RETURN ELEVATOR DRIVE	833854M2	1	1000335	4014486465754

MASSEY FERGUSON 760 - 765



BISO - Schrattecker
BIZON
CASE INTL. HARVESTER
CLAAS
DEUTZ-FAHR
DRONNING-BORG
FENDT
FORTSCHRITT
JOHN DEERE
KRONE
LAVERDA
MASSEY FERGUSON
NEW HOLLAND
ROSTSELMASH

No.	Application	OEM - PN	Set	Optibelt AP-Nr.	EAN
1	HYDRAULIC PUMP DRIVE (SERIAL NR. 00511-2474)	222882M2	1	1000232	4014486463262
2	RADIATOR FAN DRIVE	259047M91	2	1000131	4014486461473
3	ALTERNATOR DRIVE	1687531M1	1	1002558	4014486495034
4	AIR CONDITIONING COMPRESSOR DRIVE	1686883M1	1	1002534	4014486494556
4	AIR CONDITIONING COMPRESSOR DRIVE (SERIAL NR. 5829-7663)	843045M1	1	1002543	4014486494723
5	MAIN DRIVE	833865M1	1	1003665	4014486490879
6	AIR INTAKE DRIVE	833867M1	1	1000119	4014486461305
10	STRAW CHOPPER DRIVE (SERIAL NR. 9413 - ...)	843948M1	1	1001451	4014486459593
10	STRAW CHOPPER DRIVE (SERIAL NR. ... - 9413)	833871M1	1	1001747	4014486485417
11	STRAW CHOPPER DRIVE (SERIAL NR. 9413 - ...)	843747M1	1	1000827	4014486472547
12	STRAW CHOPPER DRIVE (SERIAL NR. 9413 - ...)	832906M1	1	1000758	4014486471595
12	STRAW CHOPPER DRIVE (SERIAL NR. ... - 9413)	833872M1	1	1000762	4014486471632
12	STRAW CHOPPER DRIVE	843760M1	1	1000803	4014486472233
14	STRAW WALKER DRIVE	833860M1	1	1000820	4014486472462
15	SHAKER SHOE DRIVE	273757M91	2	1000381	4014486466447
16	SHAKER SHOE - COUNTERSHAFT - FAN (SERIAL NR. 9413 - ...)	281560M91	2	1002782	4014486464832
16	SHAKER SHOE - COUNTERSHAFT - FAN (SERIAL NR. ... - 9413)	274015M91	1	1003436	4014486464795
17	CLEANING FAN DRIVE	833863M1	1	1001400	4014486459067
20	REEL DRIVE	834140M1	1	1000734	4014486471281
21	REEL DRIVE VARIABLE SPEED	833768M1	1	1001402	4014486459081
22	KNIFE WOBBLE RIDIG CUT BAR - 15 FEET - 24 FEET	834190M1	1	1000597	4014486469295
22	KNIFE DRIVE - RIDIG CUT BAR 13 FEET	834058M1	1	1000598	4014486469301

MASSEY FERGUSON 760 - 765, 760 OLD

No.	Application	OEM - PN	Set	Optibelt AP-Nr.	EAN
22	KNIFE WOBBLE - FLOATING CUT BAR	833962M1	1	1000673	4014486470444
23	REEL DRIVE COUNTERSHAFT	834139M1	1	1000567	4014486468748
24	DISCHARGE DRIVE GRAIN TANK	833862M3	1	1003597	4014486485059
1	REEL DRIVE	834140M1	1	1000734	4014486471281
2	REEL DRIVE VARIABLE SPEED	833768M1	1	1001402	4014486459081
3	REEL DRIVE	834139M1	1	1000567	4014486468748
4	WOBBLE BOX DRIVE	834190M1	1	1000597	4014486469295
4	WOBBLE BOX DRIVE	834058M1	1	1000598	4014486469301
6	MAIN DRIVE	833865M1	1	1003665	4014486490879
7	AIR INTAKE DRIVE	833867M1	1	1000119	4014486461305
8	DISCHARGE DRIVE GRAIN TANK	833862M3	1	1003597	4014486485059
11	STRAW WALKER DRIVE	833860M1	1	1000820	4014486472462
14	HYDRAULIC PUMP DRIVE	222882M2	1	1000232	4014486463262
18	AIR CONDITIONING COMPRESSOR DRIVE	834492M2	1	1000211	4014486462593
18	AIR CONDITIONING COMPRESSOR DRIVE	843045M1	1	1002543	4014486494723
21	STRAW CHOPPER DRIVE	833871M1	1	1001747	4014486485417
23	STRAW CHOPPER DRIVE	833872M1	1	1000762	4014486471632
23	STRAW CHOPPER DRIVE	843324M1	1	1000804	4014486472240
24	RETURN ELEVATOR DRIVE	833854M2	1	1000335	4014486465754

MASSEY FERGUSON 86 (F), 86 OLD



No.	Application	OEM - PN	Set	Optibelt AP-Nr.	EAN
1	TABLE FEEDER DRUM	412236M1	1	1003530	4014486470369
2	TANK UNLOADER DRIVE	412074M1	1	1003402	4014486463170
3	FANNING MILL (UPPER)	402605M1	1	1003428	4014486464238
4	HYDRAULIC PUMP DRIVE	402604M1	1	1003390	4014486462579
8	TRACTION (UPPER)	412333M1	1	1001159	4014486497410
9	TRACTION (LOWER)	401110M1	1	1001160	4014486497397
10	REDUCER	412237M1	1	1000886	4014486473278
11	AUGER DRIVE (FRONT)	412399M1	1	1000557	4014486468519
12	KNIFE DRIVE	402607M1	1	1003515	4014486469653
15	FANNING MILL	402604M1	1	1003390	4014486462579
1	TRACTION DRIVE	412333M1	1	1001159	4014486497410
2	TRACTION DRIVE	401110M1	1	1001160	4014486497397
3	HYDRAULIC PUMP DRIVE	403041M1	1	1000206	4014486462463
5	KNIFE DRIVE	402607M1	1	1003515	4014486469653
7	KNIFE DRIVE (UPPER)	412237M1	1	1000886	4014486473278
8	FEEDER AUGER	412399M1	1	1000557	4014486468519
9	STRAW BALER	328656M1	1	1000527	4014486468076
10	FANNING MILL	402604M1	1	1003390	4014486462579
11	FANNING MILL (UPPER)	402605M1	1	1003428	4014486464238
12	TANK UNLOADER DRIVE	412074M1	1	1003402	4014486463170
13	FEEDER DRIVE	412236M1	1	1003530	4014486470369

MASSEY FERGUSON 87 (F), 87 OLD

No.	Application	OEM - PN	Set	Optibelt AP-Nr.	EAN
1	TABLE FEEDER DRUM	412236M1	1	1003530	4014486470369
2	TANK UNLOADER DRIVE	412074M1	1	1003402	4014486463170
3	FANNING MILL (UPPER)	402605M1	1	1003428	4014486464238
4	HYDRAULIC PUMP DRIVE	417468M1	1	1003397	4014486462821
9	TRACTION (LOWER)	401110M1	1	1001160	4014486497397
10	REDUCER	412237M1	1	1000886	4014486473278
11	AUGER DRIVE (FRONT)	412399M1	1	1000557	4014486468519
12	KNIFE DRIVE	402607M1	1	1003515	4014486469653
15	FANNING MILL	621262M1	1	1003334	4014486462586
1	TRACTION DRIVE	412333M1	1	1001159	4014486497410
2	TRACTION DRIVE	401110M1	1	1001160	4014486497397
3	HYDRAULIC PUMP DRIVE	403041M1	1	1000206	4014486462463
5	KNIFE DRIVE	402607M1	1	1003515	4014486469653
7	KNIFE DRIVE (UPPER)	412237M1	1	1000886	4014486473278
8	FEEDER AUGER	412399M1	1	1000557	4014486468519
9	STRAW BALER	328656M1	1	1000527	4014486468076
10	FANNING MILL	402604M1	1	1003390	4014486462579
11	FANNING MILL (UPPER)	402605M1	1	1003428	4014486464238
12	TANK UNLOADER DRIVE	412074M1	1	1003402	4014486463170
13	FEEDER DRIVE	412236M1	1	1003530	4014486470369

MASSEY FERGUSON CHALLENGER 660



BISO - Schrattecker
BIZON
CASE INTL. HARVESTER
CLAAS
DEUTZ-FAHR
DRONNING-BORG
FENDT
FORTSCHRITT
JOHN DEERE
KRONE
LAVERDA
MASSEY FERGUSON
ROSTSELMASH
NEW HOLLAND

No.	Application	OEM - PN	Set	Optibelt AP-Nr.	EAN
1	UNLOADING DRIVE	101102M1	1	1001662	4014486486186
2	ELEVATOR DRIVE (SERIAL NR. ... - HP87101) GRAIN	227455M1	1	1000698	4014486470802
3	ELEVATOR DRIVE (SERIAL NR. HP87101 - ...) GRAIN	71403685	1	1004121	4014486522952
4	SHAKER SHOE PITMAN DRIVE	71390199	1	1003933	4014486485301
5	BEATER DRIVE	71386352	1	1001900	4014486489606
6	MAIN COUNTERSHAFT DRIVE	71390188	1	1001877	4014486489255
7	TANDEM PUMP DRIVE (SERIAL NR. ... - HR87101)	71418976	1	1003716	4014486519839
9	HEADER COUNTERSHAFT TO PIVOT SHAFT (SERIAL NR. HP87101 - ...)	71398388	1	1001391	4014486475098
10	BEATER TO HEADER COUNTERSHAFT DRIVE (SERIAL NR. ... - HP87101)	71379105	1	1001170	4014486491814
12	RETURN ELEVATOR DRIVE	71385801	1	1003628	4014486519013
13	CHOPPER DRIVE - 2ND STAGE (SERIAL NR. ... - HR87101)	71388712	1	1000821	4014486472479
14	CHOPPER DRIVE - 2ND STAGE (SERIAL NR. HR87101 - ...)	71406339	1	1003617	4014486486780
15	SPREADER DRIVE	1680230w1	1	1004118	4014486522921
16	SPREADER JACKSHAFT DRIVE	227455M1	1	1000698	4014486470802
18	CHOPPER DRIVE - 1ST STAGE (SERIAL NR. HR87101 - ...)	71406361	1	1001645	4014486485974
19	AIR CONDITIONING COMPRESSOR DRIVE	71148120	1	1002556	4014486494983
24	BEATER TO FEEDER HOUSE JACKSHAFT DRIVE (SERIAL NR. HP87101 - ...)	71398384	1	1004135	4014486523171
25	VARIABLE SPEED TO HEADER COUNTERSHAFT (SERIAL NR. HP87101 - ...)	71399505	1	1001530	4014486460490
26	JACKSHAFT - HEADER COUNTERSHAFT (SERIAL NR. HP87101 - ...)	71399519	1	1001148	4014486490121
27	ROTARY SCREEN DRIVE (SERIAL NR. HR87101 - ...)	71396754	1	1003660	4014486518399

MASSEY FERGUSON CHALLENGER 660 B



No.	Application	OEM - PN	Set	Optibelt AP-Nr.	EAN
3	SHAKER SHOE PITMAN DRIVE	71390199	1	1003933	4014486485301
5	MAIN COUNTERSHAFT DRIVE	71390188	1	1001877	4014486489255
7	FEEDER PIVOT SHAFT DRIVE	71427255	1	1000801	4014486472202
9	RETURN ELEVATOR DRIVE	71385801	1	1003628	4014486519013
10	CHOPPER DRIVE - 2ND STAGE	71406339	1	1003617	4014486486780
11	SPREADER DRIVE (SECONDARY)	1680230W1	1	1004118	4014486522921
13	CHOPPER DRIVE - 1ST STAGE	71406338	1	1001648	4014486486001
14	AIR CONDITIONING COMPRESSOR DRIVE	71148120	1	1002556	4014486494983
16	BEATER TO FEEDER HOUSE JACKSHAFT	71398384	1	1004135	4014486523171
17	VARIABLE SPEED TO HEADER COUNTERSHAFT	71399505	1	1001530	4014486460490
18	JACKSHAFT - HEADER COUNTERSHAFT	71399519	1	1001148	4014486490121
19	ROTARY SCREEN DRIVE	71396754	1	1003660	4014486518399

MASSEY FERGUSON CHALLENGER 670



No.	Application	OEM - PN	Set	Optibelt AP-Nr.	EAN
1	UNLOADING DRIVE	101102M1	1	1001662	4014486486186
2	ELEVATOR DRIVE (SERIAL NR. ... - HP87101) GRAIN	227455M1	1	1000698	4014486470802
3	ELEVATOR DRIVE (SERIAL NR. HP87101 - ...) GRAIN	71403685	1	1004121	4014486522952
4	SHAKER SHOE PITMAN DRIVE	71390199	1	1003933	4014486485301
6	MAIN COUNTERSHAFT DRIVE	71390188	1	1001877	4014486489255
7	ROTOR PUMP DRIVE (SERIAL NR. ... - HR36101)	71418976	1	1003716	4014486519839
9	HEADER COUNTERSHAFT TO PIVOT SHAFT (SERIAL NR. HP36101 - ...)	71398388	1	1001391	4014486475098
10	BEATER TO HEADER COUNTERSHAFT DRIVE (SERIAL NR. ... - HP36101)	71379105	1	1001170	4014486491814
12	RETURN ELEVATOR DRIVE	71385801	1	1003628	4014486519013
13	CHOPPER DRIVE - 2ND STAGE (SERIAL NR. ... - HR36101)	71388712	1	1000821	4014486472479
14	CHOPPER DRIVE - 2ND STAGE (SERIAL NR. HR36101 - ...)	71406339	1	1003617	4014486486780
15	SPREADER DRIVE	1680230W1	1	1004118	4014486522921
16	SPREADER JACKSHAFT DRIVE	227455M1	1	1000698	4014486470802
18	CHOPPER DRIVE - 1ST STAGE (SERIAL NR. HR36101 - ...)	71406361	1	1001645	4014486485974
19	AIR CONDITIONING COMPRESSOR DRIVE	71148120	1	1002556	4014486494983
24	BEATER TO FEEDER HOUSE JACKSHAFT DRIVE (SERIAL NR. HP36101 - ...)	71398384	1	1004135	4014486523171
25	VARIABLE SPEED TO HEADER COUNTERSHAFT (SERIAL NR. HP36101 - ...)	71399505	1	1001530	4014486460490
26	JACKSHAFT - HEADER COUNTERSHAFT (SERIAL NR. HP36101 - ...)	71399519	1	1001148	4014486490121
27	ROTARY SCREEN DRIVE	71396754	1	1003660	4014486518399

MASSEY FERGUSON CHALLENGER 670 B



No.	Application	OEM - PN	Set	Optibelt AP-Nr.	EAN
3	SHAKER SHOE PITMAN DRIVE	71390199	1	1003933	4014486485301
5	MAIN COUNTERSHAFT DRIVE	71390188	1	1001877	4014486489255
6	ROTOR PUMP DRIVE	71418976	1	1003716	4014486519839
7	PROPULSION PUMP DRIVE	71418978	1	1003717	4014486519693
8	FEEDER PIVOT SHAFT DRIVE	71427255	1	1000801	4014486472202
10	RETURN ELEVATOR DRIVE	71385801	1	1003628	4014486519013
11	CHOPPER DRIVE - 2ND STAGE	71406339	1	1003617	4014486486780
12	SPREADER DRIVE (SECONDARY)	1680230W1	1	1004118	4014486522921
14	CHOPPER DRIVE - 1ST STAGE	71406338	1	1001648	4014486486001
15	AIR CONDITIONING COMPRESSOR DRIVE	71148120	1	1002556	4014486494983
17	BEATER TO FEEDER HOUSE JACKSHAFT	71398384	1	1004135	4014486523171
18	VARIABLE SPEED TO HEADER COUNTERSHAFT	71399505	1	1001530	4014486460490
19	JACKSHAFT - HEADER COUNTERSHAFT	71399519	1	1001148	4014486490121
20	ROTARY SCREEN DRIVE	71396754	1	1003660	4014486518399

MASSEY FERGUSON CHALLENGER 680 B



No.	Application	OEM - PN	Set	Optibelt AP-Nr.	EAN
2	ELEVATOR DRIVE GRAIN	71403685	1	1004121	4014486522952
3	SHAKER SHOE PITMAN DRIVE	71390199	1	1003933	4014486485301
5	MAIN COUNTERSHAFT DRIVE	71403721	1	1002009	4014486491395
6	ROTOR PUMP DRIVE	71406285	1	1001961	4014486490695
8	FEEDER CONVEYOR DRIVE	71427255	1	1000801	4014486472202
10	CHOPPER DRIVE - 1ST STAGE	71406338	1	1001648	4014486486001
11	SPREADER DRIVE (SECONDARY)	1680230W1	1	1004118	4014486522921
12	CHOPPER DRIVE - 2ND STAGE	71406339	1	1003617	4014486486780
13	BEATER TO FEEDER HOUSE JACKSHAFT	71398384	1	1004135	4014486523171
14	JACKSHAFT - HEADER COUNTERSHAFT	71399519	1	1001148	4014486490121
17	CLEANING FAN VARIABLE SPEED DRIVE	71400662	1	1001401	4014486459074
18	RETURN ELEVATOR DRIVE	71385801	1	1003628	4014486519013
19	ROTARY SCREEN DRIVE	71396754	1	1003660	4014486518399

MASSEY FERGUSON MF 27

No.	Application	OEM - PN	Set	Optibelt AP-Nr.	EAN
1	FEEDER DRUM - COUNTERSHAFT	41983500	1	1000611	4014486469493
2	CRANKSHAFT - COUNTERSHAFT	41964300	1	1003405	4014486463309
3	COUNTERSHAFT (UPPER) - FEEDER SHAFT	41989200	1	1000908	4014486473568
3	COUNTERSHAFT (UPPER) - FEEDER SHAFT	41989400	1	1000911	4014486473605
4	FEEDER SHAFT (UPPER) - STRIPPER BEATER	41991700	1	1001844	4014486488739
7	INTERMEDIATE SHAFT - ECCENTRIC SHAFT	41982400	1	1003501	4014486469059
8	AUGER - LOWER RETURN AUGER (GRAIN)	41990100	1	1001377	4014486474916
9	COUNTER SELECTOR - INTERMEDIATE SHAFT	41988000	1	1000698	4014486470802
10	STRIPPER BEATER - COUNTER SELECTOR	41934800	3	1002768	4014486465228
11	COUNTER SELECTOR - ENGINE	41993400	1	1003633	4014486488609
12	ENGINE - HYDRAULIC PUMP	41929000	1	1000251	4014486463897
12	ENGINE - HYDRAULIC PUMP	41930200	1	1000260	4014486464108
13	COUNTER SELECTOR - COUNTER DRIVE STRAW CHOPPER	41942100	1	1000404	4014486466676
14	COUNTER DRIVE STRAW CHOPPER	41987300	1	1000815	4014486472400
15	AWNER SHAFT	41912400	1	1003381	4014486461732
18	COUNTER SELECTOR - DISCHARGE AUGER	41936200	2	1002770	4014486465648
20	FILLING AUGER - STRIPPER BEATER	41982500	1	1000585	4014486469066
25	MAIN FAN SELECTOR - STRIPPER BEATER	41987900	1	1000575	4014486468847
28	MAIN FAN SELECTOR - MAIN FAN	41987900	1	1000575	4014486468847
28	MAIN FAN SELECTOR - MAIN FAN	41982200	1	1003499	4014486469004

MASSEY FERGUSON MF 29



No.	Application	OEM - PN	Set	Optibelt AP-Nr.	EAN
1	FEEDER DRUM - COUNTERSHAFT	41983500	1	1000611	4014486469493
1	FEEDER DRUM - COUNTERSHAFT	41983600	1	1000611	4014486469493
2	CRANKSHAFT - COUNTERSHAFT	41963900	1	1000233	4014486463293
2	CRANKSHAFT - COUNTERSHAFT	41964300	1	1003405	4014486463309
3	COUNTERSHAFT (UPPER) - FEEDER SHAFT	41989200	1	1000908	4014486473568
3	COUNTERSHAFT - UPPER BEATER SHAFT	41989400	1	1000911	4014486473605
4	FEEDER SHAFT (UPPER) - STRIPPER BEATER	41991700	1	1001844	4014486488739
7	INTERMEDIATE SHAFT - ECCENTRIC SHAFT	41982500	1	1000585	4014486469066
7	INTERMEDIATE SHAFT - ECCENTRIC SHAFT	41982400	1	1003501	4014486469059
8	AUGER - LOWER RETURN AUGER (GRAIN)	41990100	1	1001377	4014486474916
8	AUGER - LOWER RETURN AUGER (GRAIN)	41990400	1	1003581	4014486474930
9	COUNTER SELECTOR - INTERMEDIATE SHAFT	41988000	1	1000698	4014486470802
10	STRIPPER BEATER - COUNTER SELECTOR	41934800	3	1002768	4014486465228
11	COUNTER SELECTOR - ENGINE	41993400	1	1003633	4014486488609
12	ENGINE - HYDRAULIC PUMP	41929000	1	1000251	4014486463897
12	ENGINE - HYDRAULIC PUMP	41930200	1	1000260	4014486464108
13	COUNTER SELECTOR - COUNTER DRIVE STRAW CHOPPER	41942100	1	1000404	4014486466676
14	COUNTER DRIVE STRAW CHOPPER	41987300	1	1000815	4014486472400
15	AWNER SHAFT	41912300	1	1003380	4014486461749
15	AWNER SHAFT	41912400	1	1003381	4014486461732
16	COUNTER SELECTOR - THRESHING DRUM	41980900	1	1001526	4014486460452
17	COUNTER SELECTOR - AWNER SHAFT	41990400	1	1003581	4014486474930

MASSEY FERGUSON MF 29, MF 30

No.	Application	OEM - PN	Set	Optibelt AP-Nr.	EAN
18	COUNTER SELECTOR - DISCHARGE AUGER	41936200	2	1002770	4014486465648
20	FILLING AUGER - STRIPPER BEATER	41982500	1	1000585	4014486469066
25	MAIN FAN VARIABLE SPEED DRIVE - STRIPPER BEATER	41987900	1	1000575	4014486468847
28	MAIN FAN VARIABLE SPEED DRIVE	41987900	1	1000575	4014486468847
28	MAIN FAN SELECTOR - MAIN FAN	41982100	1	1000582	4014486469011
28	MAIN FAN SELECTOR - MAIN FAN	41982200	1	1003499	4014486469004
1	STRIPPER BEATER - COUNTERSHAFT	41934800	3	1002768	4014486465228
2	COUNTERSHAFT (DIESEL ENGINE)	41990051	1	1001877	4014486489255
3	DISCHARGE AUGER SHAFT (DIESEL ENGINE)	41990050	1	1003600	4014486485196
5	COUNTERSHAFT - INTERMEDIATE DRIVE FOR STRAW	41942200	1	1000410	4014486466737
6	KNIFE DRIVE - COUNTERSHAFT	41985600	1	1000693	4014486470741
9	FEEDER SHAFT (UPPER) - STRIPPER BEATER	41991700	1	1001844	4014486488739
10	INTERMEDIATE SHAFT - ECCENTRIC SHAFT	41982100	1	1000582	4014486469011
11	INTERMEDIATE SHAFT - COUNTERSHAFT	41984100	1	1000655	4014486470185
12	INTERMEDIATE SHAFT - STRAW SHAKER CRANK	41990068	1	1001368	4014486474824
13	INTERMEDIATE SHAFT - STRAW CHOPPER	41978400	1	1001725	4014486487084
14	KNIFE DRIVE - COUNTERSHAFT	41986300	1	1000756	4014486471571
17	AIR CONDITIONING COMPRESSOR DRIVE	41991000	1	1002346	4014486478792
19	AIR CONDITIONING COMPRESSOR DRIVE - SUCTION TRAINER	41990009	1	1002357	4014486478907
20	DUST EXTRACTOR - COUNTERSHAFT	41936700	1	1000327	4014486465556
21	DISCHARGE AUGER SHAFT - INTERMEDIATE DRIVE - ELEVATOR	41979600	1	1003347	4014486486285

MASSEY FERGUSON MF 30, MF 31



23	INTERMEDIATE SHAFT - FILL ELEVATOR - STRIP BEATER	41950100	1	1000627	4014486469776
25	COUNTERSHAFT - GRAIN SEPARATOR	41982100	1	1000582	4014486469011
26	MAIN FAN VARIABLE SPEED DRIVE	41982100	1	1000582	4014486469011
27	MAIN FAN VARIABLE SPEED DRIVE - STRIPPER BEATER	41987900	1	1000575	4014486468847
28	COUNTERSHAFT - THRESHING DRUM	41980900	1	1001526	4014486460452
29	MAIN FAN VARIABLE SPEED DRIVE - RETURN ELEVATOR	41950400	1	1003517	4014486469691
1	COUNTERSHAFT - FEEDER DRUM	41983500	1	1000611	4014486469493
1	COUNTERSHAFT - FEEDER DRUM	41983600	1	1000611	4014486469493
2	COUNTERSHAFT - CRANKSHAFT	41963900	1	1000233	4014486463293
2	COUNTERSHAFT - CRANKSHAFT	41964300	1	1003405	4014486463309
3	COUNTERSHAFT - STRIPPER BEATER	41989200	1	1000908	4014486473568
3	COUNTERSHAFT - STRIPPER BEATER	41989400	1	1000911	4014486473605
4	FEEDER SHAFT (UPPER) - STRIPPER BEATER	41991700	1	1001844	4014486488739
7	INTERMEDIATE SHAFT - ECCENTRIC SHAFT	41982500	1	1000585	4014486469066
7	INTERMEDIATE SHAFT - ECCENTRIC SHAFT	41982400	1	1003501	4014486469059
8	AUGER - LOWER RETURN AUGER (GRAIN)	41990100	1	1001377	4014486474916
8	AUGER - LOWER RETURN AUGER (GRAIN)	41990069	1	1001378	4014486474923
8	AUGER - LOWER RETURN AUGER (GRAIN)	41990400	1	1003581	4014486474930
9	COUNTER SELECTOR - INTERMEDIATE SHAFT	41988000	1	1000698	4014486470802
10	STRIPPER BEATER - COUNTER SELECTOR	41934800	3	1002768	4014486465228
11	COUNTER SELECTOR - ENGINE	41991300	1	1001836	4014486488616

MASSEY FERGUSON MF 31

No.	Application	OEM - PN	Set	Optibelt AP-Nr.	EAN
11	COUNTER SELECTOR - ENGINE	41993400	1	1003633	4014486488609
12	ENGINE - HYDRAULIC PUMP	41930200	1	1000260	4014486464108
13	COUNTER SELECTOR - COUNTER DRIVE STRAW CHOPPER	41942100	1	1000404	4014486466676
14	COUNTER DRIVE STRAW CHOPPER	41987600	1	1000853	4014486472844
15	AWNER SHAFT	41912300	1	1003380	4014486461749
15	AWNER SHAFT	41912400	1	1003381	4014486461732
16	COUNTER SELECTOR - THRESHING DRUM	41980900	1	1001526	4014486460452
17	COUNTER SELECTOR - AWNER SHAFT	41990069	1	1001378	4014486474923
17	COUNTER SELECTOR - AWNER SHAFT	41990400	1	1003581	4014486474930
18	COUNTER SELECTOR - DISCHARGE AUGER	41936200	2	1002770	4014486465648
20	FILLING AUGER - STRIPPER BEATER	41982500	1	1000585	4014486469066
25	MAIN FAN SELECTOR - STRIPPER BEATER	41987900	1	1000575	4014486468847
28	MAIN FAN SELECTOR - MAIN FAN	41987900	1	1000575	4014486468847
28	MAIN FAN SELECTOR - MAIN FAN	41982100	1	1000582	4014486469011
28	MAIN FAN SELECTOR - MAIN FAN	41982200	1	1003499	4014486469004

MASSEY FERGUSON MF 32



No.	Application	OEM - PN	Set	Optibelt AP-Nr.	EAN
1	STRIPPER BEATER - COUNTERSHAFT	41934800	3	1002768	4014486465228
2	COUNTERSHAFT (DIESEL ENGINE)	41990051	1	1001877	4014486489255
3	DISCHARGE AUGER SHAFT (DIESEL ENGINE)	41990050	1	1003600	4014486485196
5	COUNTERSHAFT - INTERMEDIATE DRIVE FOR STRAW	41942200	1	1000410	4014486466737
6	KNIFE DRIVE - COUNTERSHAFT	41985600	1	1000693	4014486470741
9	FEEDER SHAFT (UPPER) - STRIPPER BEATER	41991700	1	1001844	4014486488739
10	INTERMEDIATE SHAFT - ECCENTRIC SHAFT	41982100	1	1000582	4014486469011
11	INTERMEDIATE SHAFT - COUNTERSHAFT	41984100	1	1000655	4014486470185
12	INTERMEDIATE SHAFT - STRAW SHAKER CRANK	41990068	1	1001368	4014486474824
13	INTERMEDIATE SHAFT - STRAW CHOPPER	41978400	1	1001725	4014486487084
14	KNIFE DRIVE - COUNTERSHAFT	41986300	1	1000756	4014486471571
17	AIR CONDITIONING COMPRESSOR DRIVE	41991000	1	1002346	4014486478792
19	AIR CONDITIONING COMPRESSOR DRIVE - SUCTION TRAINER	41990009	1	1002357	4014486478907
20	DUST EXTRACTOR - COUNTERSHAFT	41936700	1	1000327	4014486465556
21	DISCHARGE AUGER SHAFT - INTERMEDIATE DRIVE - ELEVATOR	41979600	1	1003347	4014486486285
23	INTERMEDIATE SHAFT - FILL ELEVATOR - STRIP BEATER	41950100	1	1000627	4014486469776
25	COUNTERSHAFT - GRAIN SEPARATOR	41982100	1	1000582	4014486469011
26	MAIN FAN VARIABLE SPEED DRIVE	41982100	1	1000582	4014486469011
27	MAIN FAN VARIABLE SPEED DRIVE - STRIPPER BEATER	41987900	1	1000575	4014486468847
28	COUNTERSHAFT - THRESHING DRUM	41980900	1	1001526	4014486460452
29	MAIN FAN VARIABLE SPEED DRIVE - RETURN ELEVATOR	41950400	1	1003517	4014486469691

MASSEY FERGUSON MF 34



No.	Application	OEM - PN	Set	Optibelt AP-Nr.	EAN
11		41979800	1	1001990	4014486491104
12		41990001	1	1002212	4014486477634
29		41981000	1	1001539	4014486460582

MASSEY FERGUSON MF 38



BISO - Schrottenecker
BIZON
CASE INTL. HARVESTER
CLAAS
DEUTZ-FAHR
DRONNING-BORG
FENDT
FORTSCHRITT
JOHN DEERE
KRONE
LAVERDA
MASSEY FERGUSON
NEW HOLLAND
ROSTSELMASH

No.	Application	OEM - PN	Set	Optibelt AP-Nr.	EAN
1	STRIPPER BEATER - COUNTERSHAFT	41979900	1	1003576	4014486492217
2	COUNTERSHAFT (DIESEL ENGINE)	41979400	1	1001251	4014486492071
3	DISCHARGE AUGER SHAFT (DIESEL ENGINE)	41979100	1	1001607	4014486485332
5	COUNTERSHAFT - INTERMEDIATE DRIVE FOR STRAW	41979600	1	1003347	4014486486285
6	INTERMEDIATE SHAFT - STRAW CHOPPER	41978900	1	1001730	4014486487145
7	KNIFE DRIVE - COUNTERSHAFT	41985600	1	1000693	4014486470741
10	STRIPPER BEATER	41979800	1	1001990	4014486491104
11	STRIPPER BEATER - INTERMEDIATE SHAFT	41990001	1	1002212	4014486477634
12	INTERMEDIATE SHAFT - ECCENTRIC SHAFT	41933700	2	1002760	4014486464993
13	INTERMEDIATE SHAFT - STRAW SHAKER CRANK	41979000	1	1001632	4014486485776
14	KNIFE DRIVE - COUNTERSHAFT	41986300	1	1000756	4014486471571
17	SUCTION TRAINER - DUST EXTRACTOR	41911000	1	1000143	4014486461619
19	INTERMEDIATE SHAFT - FILL ELEVATOR	41986100	1	1000675	4014486470475
20	DUST EXTRACTOR - FILL ELEVATOR	41998800	1	1000278	4014486464528
22	COUNTERSHAFT DRIVE	41937500	2	1002773	4014486465891
23	DISCHARGE AUGER SHAFT	41978800	1	1001683	4014486486544
25	AIR CONDITIONING COMPRESSOR DRIVE	41909000	1	1003748	4014486496048
27	MAIN FAN VARIABLE SPEED DRIVE - STRIPPER BEATER	41981200	1	1001427	4014486459357
28	MAIN FAN VARIABLE SPEED DRIVE	41981100	1	1001436	4014486459449
29	STRIPPER BEATER - INTERMEDIATE DRIVE VARIATOR	41981000	1	1001539	4014486460582
30	INTERMEDIATE SHAFT - VARIATOR DRIVE THRESHING DRUM	41985200	1	1000603	4014486469370
31	INTERMEDIATE SHAFT - VARIATOR DRIVE THRESHING DRUM	41985300	1	1003514	4014486469622

NEW HOLLAND 1520, 1530

No.	Application	OEM - PN	Set	Optibelt AP-Nr.	EAN
1	REEL DRIVE	80333255	1	1000775	4014486471847
2	KNIFE DRIVE	80337415	1	1000625	4014486469738
3	REEL DRIVE VARIABLE SPEED	80334065	1	1001403	4014486459098
4	INTERMEDIATE SHAFT - KNIFE	80330715	1	1000726	4014486471182
5	STRAW ELEVATOR DRIVE	80230059	1	1000654	4014486470178
8	HYDRAULIC PUMP DRIVE	80230043	1	1003400	4014486462906
12	FAN DRIVE (DEUTZ ENGINE)	80327040	1	1002267	4014486478358
16	UNLOADING SYSTEM	80326298	1	1003489	4014486468427
17	DRUM DRIVE VARIABLE SPEED	80230078	1	1001509	4014486460254
18	FAN DRIVE VARIABLE SPEED	80330204	1	1000243	4014486463613
1	REEL DRIVE	80333255	1	1000775	4014486471847
2	KNIFE DRIVE	80337415	1	1000625	4014486469738
3	REEL DRIVE VARIABLE SPEED	80334065	1	1001403	4014486459098
4	INTERMEDIATE KNIFE DRIVE	80330715	1	1000726	4014486471182
6	ECCENTRIC SHAFT DRIVE	80230060	1	1003534	4014486470536
9	HYDRAULIC PUMP DRIVE	80230043	1	1003400	4014486462906
11	FAN DRIVE (DEUTZ ENGINE)	80336386	1	1000027	4014486483482
12	ALTERNATOR DRIVE (DEUTZ ENGINE)	80336426	1	1000020	4014486483390
12	ALTERNATOR DRIVE (DEUTZ ENGINE)	80386155	1	1000022	4014486483420
14	ELEVATOR DRIVE GRAIN	80230059	1	1000654	4014486470178
16	TAILINGS ELEVATOR DRIVE	80230057	1	1000603	4014486469370

NEW HOLLAND 1530, 1540



18	UNLOADING SYSTEM	80230103	1	1000881	4014486473216
19	DRUM DRIVE VARIABLE SPEED	80230078	1	1001509	4014486460254
21	STRAW WALKER - ECCENTRIC	80230108	1	1003452	4014486465617
	HYDRAULIC PUMP DRIVE	80350236	1	1003640	4014486489002
1	REEL DRIVE	80333255	1	1000775	4014486471847
2	KNIFE DRIVE	80337415	1	1000625	4014486469738
3	REEL DRIVE VARIABLE SPEED	80334065	1	1001403	4014486459098
5	DRUM DRIVE VARIABLE SPEED	80336784	1	1001506	4014486460216
7	MAIN SHAFT DRIVE	80323646	1	1001949	4014486490541
8	UNLOADING SYSTEM	80333958	1	1000715	4014486471052
9	DRUM DRIVE VARIABLE SPEED	80336784	1	1001506	4014486460216
12	ELEVATOR DRIVE GRAIN	80230164	1	1000622	4014486469660
14	TAILINGS ELEVATOR DRIVE	80323413	1	1000577	4014486468922
16	FAN DRIVE	80230059	1	1000654	4014486470178
19	DEUTZ ENGINE	80386155	1	1000022	4014486483420
19	DEUTZ ENGINE	80336386	1	1000027	4014486483482

NEW HOLLAND 1545, 1550

No.	Application	OEM - PN	Set	Optibelt AP-Nr.	EAN
1	REEL DRIVE	80333255	1	1000775	4014486471847
2	KNIFE DRIVE	80337415	1	1000625	4014486469738
3	REEL DRIVE VARIABLE SPEED	80334065	1	1001403	4014486459098
6	ECCENTRIC SHAFT DRIVE	80230060	1	1003534	4014486470536
9	HYDRAULIC PUMP DRIVE	80230043	1	1003400	4014486462906
11	STRAW WALKER DRIVE	80230108	1	1003452	4014486465617
13	ELEVATOR DRIVE GRAIN	80230059	1	1000654	4014486470178
14	TAILINGS ELEVATOR DRIVE	80230057	1	1000603	4014486469370
16	DRUM DRIVE VARIABLE SPEED	80230078	1	1001509	4014486460254
1	REEL DRIVE	80333255	1	1000775	4014486471847
2	KNIFE DRIVE	80337415	1	1000625	4014486469738
3	REEL DRIVE VARIABLE SPEED	80334065	1	1001403	4014486459098
5	DRUM DRIVE VARIABLE SPEED	80336784	1	1001506	4014486460216
6	HYDRAULIC PUMP DRIVE	80230043	1	1003400	4014486462906
7	MAIN SHAFT DRIVE	80323646	1	1001949	4014486490541
8	UNLOADING SYSTEM	80333958	1	1000715	4014486471052
9	DRUM DRIVE VARIABLE SPEED	80336784	1	1001506	4014486460216
10	GROUND SPEED DRIVE	80356025	1	1001525	4014486460445
11	GROUND SPEED VARIATOR DRIVE	80356025	1	1001525	4014486460445
14	ELEVATOR DRIVE GRAIN	80230164	1	1000622	4014486469660
16	TAILINGS ELEVATOR DRIVE	80323413	1	1000577	4014486468922

NEW HOLLAND 8030, 8040



BISO - Schrattecker
BIZON
CASE INTL. HARVESTER
CLAAS
DEUTZ-FAHR
DRONNING-BORG
FENDT
FORTSCHRITT
JOHN DEERE
KRONE
LAVERDA
MASSEY FERGUSON
NEW HOLLAND
ROTSSELMASH

No.	Application	OEM - PN	Set	Optibelt AP-Nr.	EAN
2	FORD ENGINE	80443634	1	1002543	4014486494723
6	DRUM DRIVE VARIABLE SPEED	80336784	1	1001506	4014486460216
7	FAN DRIVE VARIABLE SPEED	80230057	1	1000603	4014486469370
8	FAN DRIVE VARIABLE SPEED	80395955	1	1000555	4014486468496
9	STRAW WALKER - ECCENTRIC	80431784	1	1000328	4014486465587
13	ELEVATOR DRIVE UNIT	80422731	1	1000696	4014486470772
15	ECCENTRIC SHAFT DRIVE	80387469	1	1000700	4014486470833
16	STRAW ELEVATOR DRIVE	80066232	1	1000690	4014486470697
17	HEADER DRIVE	80330715	1	1000726	4014486471182
2	ALTERNATOR AND WATERPUMP DRIVE	80443634	1	1002543	4014486494723
2	ALTERNATOR AND WATERPUMP DRIVE	80443636	2	1002935	4014486493443
5	DRUM DRIVE VARIABLE SPEED	80336784	1	1001506	4014486460216
7	CLEANING FAN DRIVE (UPPER)	80230057	1	1000603	4014486469370
8	FAN CLEANING DRIVE (LOWER)	80395955	1	1000555	4014486468496
9	STRAW WALKER DRIVE	80431784	1	1000328	4014486465587
13	ELEVATOR BOTTOM AUGER (GRAIN)	80422731	1	1000696	4014486470772
15	ECCENTRIC SHAFT DRIVE	80387469	1	1000700	4014486470833
16	STRAW ELEVATOR DRIVE	80066232	1	1000690	4014486470697
17	HEADER DRIVE	80330715	1	1000726	4014486471182
19	INTERMEDIATE SHAFT - FAN	80427456	1	1003351	4014486464603
21	AUGER BOTTOM GRAIN TANK	80230164	1	1000622	4014486469660

NEW HOLLAND 8050



No.	Application	OEM - PN	Set	Optibelt AP-Nr.	EAN
1	REEL DRIVE	80333255	1	1000775	4014486471847
2	KNIFE DRIVE	80337415	1	1000625	4014486469738
3	REEL DRIVE VARIABLE SPEED	80334065	1	1001403	4014486459098
5	BEATER DRUM DRIVE	80451481	1	1001946	4014486490480
6	DRUM DRIVE VARIABLE SPEED	80397297	1	1001858	4014486488937
10	STRAW WALKER DRIVE	80605529	1	1000366	4014486466287
11	INTERMEDIATE SHAFT - GRAIN AUGER	80410896	1	1000567	4014486468748
12	STRAW ELEVATOR DRIVE	80393326	1	1003323	4014486485677
14	GROUND SPEED DRIVE	80230077	1	1001489	4014486459999
14	SPEED VARIATOR DRIVE	80356024	1	1001489	4014486459999
18	TAILINGS AUGER (SUPERIOR) (GRAIN)	80387469	1	1000700	4014486470833
19	FAN DRIVE	80378989	2	1002821	4014486463606
20	FAN DRIVE	80388280	1	1001410	4014486459173
21	DRUM DRIVE VARIABLE SPEED	80336784	1	1001506	4014486460216
22	BEATER DRIVE 8050 (201 = 4406001 - 4411999)	80396750	2	1002880	4014486468915
23	INTERMEDIATE SHAFT - BEATER DRIVE	80395955	1	1000555	4014486468496

NEW HOLLAND 8055

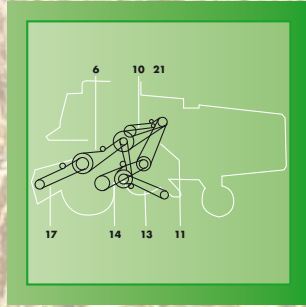
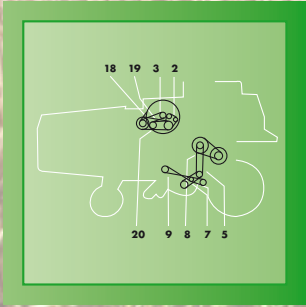

No.	Application	OEM - PN	Set	Optibelt AP-Nr.	EAN
2	ALTERNATOR AND WATERPUMP DRIVE (FORD ENGINE)	80443634	1	1002543	4014486494723
5	DRUM DRIVE VARIABLE SPEED	80336784	1	1001506	4014486460216
7	FAN DRIVE	80230057	1	1000603	4014486469370
8	FAN DRIVE	80395955	1	1000555	4014486468496
9	STRAW WALKER DRIVE	80431784	1	1000328	4014486465587
10	BEATER DRIVE	80447031	1	1001872	4014486489132
13	ELEVATOR BOTTOM AUGER (GRAIN)	80422731	1	1000696	4014486470772
15	ECCENTRIC SHAFT DRIVE	80387469	1	1000700	4014486470833
16	STRAW ELEVATOR DRIVE	80066232	1	1000690	4014486470697
16	STRAW ELEVATOR DRIVE	80424563	1	1001765	4014486487480
19	INTERMEDIATE SHAFT - DUST SCREEN DRIVE	80427456	1	1003351	4014486464603

NEW HOLLAND 8060

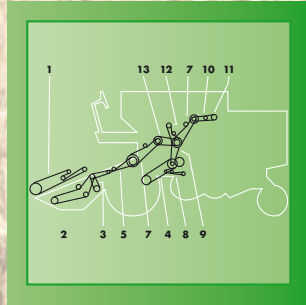
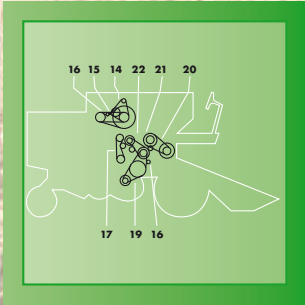

No.	Application	OEM - PN	Set	Optibelt AP-Nr.	EAN
1	REEL DRIVE	80333255	1	1000775	4014486471847
2	KNIFE DRIVE	80337415	1	1000625	4014486469738
3	REEL DRIVE VARIABLE SPEED	80334065	1	1001403	4014486459098
5	BEATER DRUM DRIVE	80451481	1	1001946	4014486490480
6	DRUM DRIVE VARIABLE SPEED	80397297	1	1001858	4014486488937
10	STRAW WALKER DRIVE	80605529	1	1000366	4014486466287
11	INTERMEDIATE SHAFT - AUGER (GRAIN)	80410896	1	1000567	4014486468748
12	STRAW ELEVATOR DRIVE	80393326	1	1003323	4014486485677
14	GROUND SPEED DRIVE	80230077	1	1001489	4014486459999
14	SPEED VARIATOR DRIVE	80356024	1	1001489	4014486459999
18	TAILINGS AUGER (SUPERIOR) (GRAIN)	80387469	1	1000700	4014486470833
19	FAN DRIVE	80378989	2	1002821	4014486463606
20	FAN DRIVE	80388280	1	1001410	4014486459173
21	DRUM DRIVE VARIABLE SPEED	80336784	1	1001506	4014486460216
22	BEATER DRIVE 8060 (330 = 4313001 - 4321999)	80396750	2	1002880	4014486468915
23	INTERMEDIATE SHAFT - BEATER DRIVE	80395955	1	1000555	4014486468496

NEW HOLLAND 8070

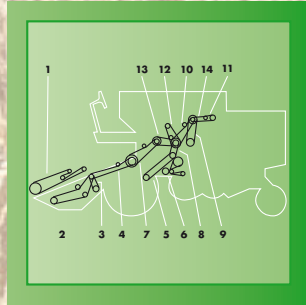
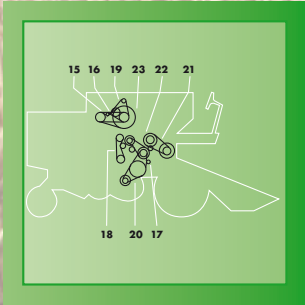

No.	Application	OEM - PN	Set	Optibelt AP-Nr.	EAN
1	REEL DRIVE	80333255	1	1000775	4014486471847
2	KNIFE DRIVE	80337415	1	1000625	4014486469738
3	REEL DRIVE VARIABLE SPEED	80334065	1	1001403	4014486459098
5	GROUND SPEED VARIATOR DRIVE	80356025	1	1001525	4014486460445
6	GROUND SPEED DRIVE (STANDARD SPEED) - PULLEY DIAMETER 404 MM	80321559	1	1001512	4014486460308
7	STRAW ELEVATOR DRIVE	80393326	1	1003323	4014486485677
8	STRAW WALKER DRIVE	80605529	1	1000366	4014486466287
10	DRUM DRIVE VARIABLE SPEED	80391650	1	1001977	4014486490947
12	INTERMEDIATE SHAFT - AUGER (GRAIN)	80410896	1	1000567	4014486468748
13	RE-THRESHER DRIVE	80451481	1	1001946	4014486490480
17	FAN DRIVE	80378989	2	1002821	4014486463606
18	TAILINGS ELEVATOR DRIVE	80387469	1	1000700	4014486470833
20	FAN DRIVE VARIABLE SPEED	80388280	1	1001410	4014486459173
21	DRUM DRIVE VARIABLE SPEED	80387460	1	1001537	4014486460568
22	COUNTERSHAFT DRIVE	80396750	2	1002880	4014486468915
23	VARIATOR DRIVE	80395955	1	1000555	4014486468496

NEW HOLLAND 8080

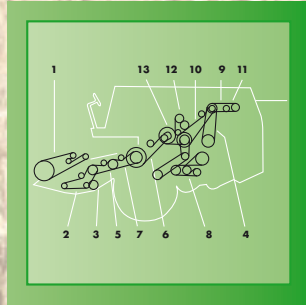
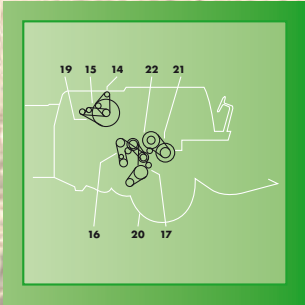

No.	Application	OEM - PN	Set	Optibelt AP-Nr.	EAN
1	REEL DRIVE	80333255	1	1000775	4014486471847
2	KNIFE DRIVE	80337415	1	1000625	4014486469738
3	REEL DRIVE VARIABLE SPEED	80334065	1	1001403	4014486459098
6	STRAW ELEVATOR DRIVE	80393326	1	1003323	4014486485677
7	HEADER DRIVE	80391143	2	1003838	4014486465563
8	STRAW WALKER DRIVE	80605529	1	1000366	4014486466287
10	DRUM DRIVE VARIABLE SPEED	80391650	1	1001977	4014486490947
12	INTERMEDIATE SHAFT - AUGER (GRAIN)	80410896	1	1000567	4014486468748
13	RE-THRESHER DRIVE	80451481	1	1001946	4014486490480
14	ALTERNATOR DRIVE (MERCEDES ENGINE OM 421)	80432642	1	1003746	4014486495928
17	FAN DRIVE	80378989	2	1002821	4014486463606
18	TAILINGS ELEVATOR DRIVE	80387469	1	1000700	4014486470833
20	FAN DRIVE VARIABLE SPEED	80388280	1	1001410	4014486459173
21	DRUM DRIVE VARIABLE SPEED	80387460	1	1001537	4014486460568
22	COUNTERSHAFT DRIVE	80396750	2	1002880	4014486468915
23	VARIATOR DRIVE	80395955	1	1000555	4014486468496

NEW HOLLAND 9630, 9640, 9645



BISO - Schrattecker
 BIZON
 CASE INTL. HARVESTER
 CLAAS
 DEUTZ-FAHR
 DRONNING-BORG
 FENDT
 FORTSCHRITT
 JOHN DEERE
 KRONE
 LAVERDA
 MASSEY FERGUSON
 NEW HOLLAND
 ROSTSELMASH

No.	Application	OEM - PN	Set	Optibelt AP-Nr.	EAN
1	MAIN DRIVE	84017742	2	1001167	4014486491784
2	DRIVE	84026761	4	1002746	4014486461862
3	FAN DRIVE	84012975	2	1002087	4014486519129
4	ALTERNATOR DRIVE	84022807	1	1001132	4014486497168
5	COMPRESSOR DRIVE	80747177	1	1002582	4014486495638
1	MAIN DRIVE	84017742	2	1001167	4014486491784
2	DRIVE	84026761	4	1002746	4014486461862
3	FAN DRIVE	84012975	2	1002087	4014486519129
4	ALTERNATOR DRIVE	84022807	1	1001132	4014486497168
5	COMPRESSOR DRIVE	80747177	1	1002582	4014486495638
1	MAIN DRIVE	84017742	2	1001167	4014486491784
2	DRIVE	84026761	4	1002746	4014486461862
3	FAN DRIVE	84012975	2	1002087	4014486519129
4	ALTERNATOR DRIVE	84022807	1	1001132	4014486497168
5	COMPRESSOR DRIVE	80747177	1	1002582	4014486495638

NEW HOLLAND 1540 AL



No.	Application	OEM - PN	Set	Optibelt AP-Nr.	EAN
	HYDRAULIC PUMP DRIVE	80350236	1	1003640	4014486489002
1	REEL DRIVE	80333255	1	1000775	4014486471847
2	KNIFE DRIVE	80337415	1	1000625	4014486469738
3	REEL DRIVE VARIABLE SPEED	80334065	1	1001403	4014486459098
5	DRUM DRIVE VARIABLE SPEED	80336784	1	1001506	4014486460216
7	MAIN SHAFT DRIVE	80323646	1	1001949	4014486490541
8	UNLOADING SYSTEM	80333958	1	1000715	4014486471052
9	DRUM DRIVE VARIABLE SPEED	80336784	1	1001506	4014486460216
12	ELEVATOR DRIVE GRAIN	80230164	1	1000622	4014486469660
14	TAILINGS ELEVATOR DRIVE	80323413	1	1000577	4014486468922
16	FAN DRIVE	80230059	1	1000654	4014486470178
19	DEUTZ ENGINE	80386155	1	1000022	4014486483420
19	DEUTZ ENGINE	80336386	1	1000027	4014486483482

NEW HOLLAND CR 9060



No.	Application	OEM - PN	Set	Optibelt AP-Nr.	EAN
2	STRAW ELEVATOR DRIVE 4HB	84072421	1	1002036	4014486491722
4	UNLOADING AUGER	87011585	1	1001636	4014486485844
5	MAIN DRIVE	87580097	1	1001978	4014486490954
6	CHOPPER DRIVE	87580100	1	1004127	4014486523096
7	BEATER DRIVE	87580099	1	1001627	4014486485660
8	BEATER DRIVE	86566287	1	1000532	4014486518818
9	SHAKER SHOE DRIVE - SELF-LEVELLING	84056913	2	1000265	4014486464207
10	CHOPPER DRIVE	87526022	1	1004128	4014486523102
11	AIR CONDITIONER UNIT : MOUNTING GROUP - WITHOUT HEATING	84818007	1	1002621	4014486480146
12	DRIVE, ROTARY SCREEN AND FAN	445930	1	1002074	4014486475623
13	DRIVE, ROTARY SCREEN AND FAN	84057085	1	1000175	4014486462036
16	FEEDER DRIVE	86589482	1	1001914	4014486489774
17	TAILINGS ELEVATORS, BOTTOM AUGER AND (RH)	84058339	2	1000200	4014486462388
18	GRAIN ELEVATOR , DRIVE	87319821	1	1004066	4014486519396
19	FAN VARI-DRIVE	84817627	1	1001135	4014486497199

NEW HOLLAND CR 9060 ELEVATION



No.	Application	OEM - PN	Set	Optibelt AP-Nr.	EAN
2	STRAW ELEVATOR DRIVE 4HB	87545653	1	1004148	4014486523294
4	UNLOADING AUGER	87011585	1	1001636	4014486485844
5	MAIN DRIVE	87545651	1	1004150	4014486523317
6	CHOPPER DRIVE	87557181	1	1004139	4014486523195
7	BEATER DRIVE	87546479	1	1001636	4014486485844
8	BEATER DRIVE	87315599	1	1004066	4014486519396
9	SHAKER SHOE DRIVE - SELF-LEVELLING	87325684	2	1004179	4014486523034
10	CHOPPER DRIVE	87526022	1	1004128	4014486523102
11	AIR CONDITIONER UNIT : MOUNTING GROUP, UNTIL BSN C 603	84818007	1	1002621	4014486480146
12	ROTARY SCREEN DRIVE AND FAN	87284244	2	1004162	4014486523409
13	DRIVE, ROTARY SCREEN AND FAN	84057085	1	1000175	4014486462036
13	DRIVE, ROTARY SCREEN AND FAN, UNTIL BSN C 599	84057085	1	1000175	4014486462036
13	DRIVE, ROTARY SCREEN AND FAN, FROM ASN D 600	87664428	1	1004111	4014486522860
14	ALTERNATOR DRIVE	747177	1	1002582	4014486495638
16	HYDRAULIC FAN DRIVE	87636309	1	1004115	4014486522907
17	FEEDER DRIVE	86589482	1	1001914	4014486489774
18	TAILINGS ELEVATORS, BOTTOM AUGER AND (RH)	84058339	2	1000200	4014486462388
19	GRAIN ELEVATOR , DRIVE	87319821	1	1004066	4014486519396

NEW HOLLAND CR 9070 ELEVATION



No.	Application	OEM - PN	Set	Optibelt AP-Nr.	EAN
2	STRAW ELEVATOR DRIVE 4HB	87545653	1	1004148	4014486523294
4	UNLOADING AUGER	87011585	1	1001636	4014486485844
5	MAIN DRIVE	87545651	1	1004150	4014486523317
6	CHOPPER DRIVE	87557181	1	1004139	4014486523195
7	BEATER DRIVE	87546479	1	1001636	4014486485844
8	BEATER DRIVE	87315599	1	1004066	4014486519396
9	SHAKER SHOE DRIVE - SELF-LEVELLING	87325684	2	1004179	4014486523034
10	CHOPPER DRIVE	87526022	1	1004128	4014486523102
11	AIR CONDITIONER UNIT : MOUNTING GROUP, UNTIL BSN C 603	84818007	1	1002621	4014486480146
11	AIR CONDITIONER UNIT : MOUNTING GROUP - WITHOUT HEATING, FROM ASN D 604	84818008	1	1004045	4014486519280
12	ROTARY SCREEN DRIVE AND FAN	87284244	2	1004162	4014486523409
13	DRIVE, ROTARY SCREEN AND FAN, UNTIL BSN C 599	84057085	1	1000175	4014486462036
13	DRIVE, ROTARY SCREEN AND FAN, ASN D 600	87664428	1	1004111	4014486522860
14	ALTERNATOR DRIVE	747177	1	1002582	4014486495638
16	HYDRAULIC FAN DRIVE	87636309	1	1004115	4014486522907
17	FEEDER DRIVE	86589482	1	1001914	4014486489774
18	TAILINGS ELEVATORS, BOTTOM AUGER AND (RH)	84058339	2	1000200	4014486462388
19	GRAIN ELEVATOR , DRIVE	87319821	1	1004066	4014486519396

NEW HOLLAND CR 9080



No.	Application	OEM - PN	Set	Optibelt AP-Nr.	EAN
2	STRAW ELEVATOR DRIVE 4HB	84072421	1	1002036	4014486491722
4	UNLOADING AUGER	87011585	1	1001636	4014486485844
5	MAIN DRIVE	87580097	1	1001978	4014486490954
6	CHOPPER DRIVE	87580100	1	1004127	4014486523096
7	BEATER DRIVE	87580099	1	1001627	4014486485660
8	BEATER DRIVE	86566287	1	1000532	4014486518818
9	SHAKER SHOE DRIVE - SELF-LEVELLING	84056913	2	1000265	4014486464207
10	CHOPPER DRIVE	87526022	1	1004128	4014486523102
11	AIR CONDITIONER UNIT : MOUNTING GROUP - WITHOUT HEATING	84818008	1	1004045	4014486519280
12	DRIVE, ROTARY SCREEN AND FAN	445930	1	1002074	4014486475623
13	DRIVE, ROTARY SCREEN AND FAN	84057085	1	1000175	4014486462036
16	FEEDER DRIVE	86589482	1	1001914	4014486489774
17	TAILINGS ELEVATORS, BOTTOM AUGER AND (RH)	84058339	2	1000200	4014486462388
18	GRAIN ELEVATOR , DRIVE	87319821	1	1004066	4014486519396
19	FAN VARI-DRIVE	84817627	1	1001135	4014486497199

NEW HOLLAND CR 9080 ELEVATION



No.	Application	OEM - PN	Set	Optibelt AP-Nr.	EAN
2	STRAW ELEVATOR DRIVE 4HB	87545653	1	1004148	4014486523294
4	UNLOADING AUGER	87011585	1	1001636	4014486485844
5	MAIN DRIVE	87545651	1	1004150	4014486523317
6	CHOPPER DRIVE	87557181	1	1004139	4014486523195
7	BEATER DRIVE	87546479	1	1001636	4014486485844
8	BEATER DRIVE	87315599	1	1004066	4014486519396
9	SHAKER SHOE DRIVE - SELF-LEVELLING	87325684	2	1004179	4014486523034
10	CHOPPER DRIVE	87526022	1	1004128	4014486523102
11	AIR CONDITIONER UNIT : MOUNTING GROUP, UNTIL BSN C 603	84818007	1	1002621	4014486480146
11	AIR CONDITIONER UNIT : MOUNTING GROUP - WITHOUT HEATING, FROM ASN D 604	84818008	1	1004045	4014486519280
12	ROTARY SCREEN DRIVE AND FAN	87284244	2	1004162	4014486523409
13	ROTARY DUST SCREEN DRIVE	9513136	1	1004110	4014486522853
14	ALTERNATOR DRIVE	747177	1	1002582	4014486495638
16	HYDRAULIC FAN DRIVE	87636309	1	1004115	4014486522907
17	FEEDER DRIVE	86589482	1	1001914	4014486489774
18	TAILINGS ELEVATORS, BOTTOM AUGER AND (RH)	84058339	2	1000200	4014486462388
19	GRAIN ELEVATOR , DRIVE	87319821	1	1004066	4014486519396

NEW HOLLAND CR 960



No.	Application	OEM - PN	Set	Optibelt AP-Nr.	EAN
2	STRAW ELEVATOR DRIVE 4 HB	84072421	1	1002036	4014486491722
4	UNLOADING AUGER	87011585	1	1001636	4014486485844
5	MAIN DRIVE	87580097	1	1001978	4014486490954
6	CHOPPER DRIVE	84320963	1	1001646	4014486485981
7	BEATER DRIVE	87580099	1	1001627	4014486485660
8	BEATER DRIVE	86566287	1	1000532	4014486518818
9	SHAKER SHOE DRIVE - SELF-LEVELLING	84056913	2	1000265	4014486464207
10	CHOPPER DRIVE	84320963	1	1001646	4014486485981
12	DRIVE, ROTARY SCREEN AND FAN	445930	1	1002074	4014486475623
13	DRIVE, ROTARY SCREEN AND FAN	84057085	1	1000175	4014486462036
14	ALTERNATOR DRIVE	747177	1	1002582	4014486495638
16	FEEDER DRIVE	86589482	1	1001914	4014486489774
17	TAILINGS ELEVATORS, BOTTOM AUGER AND (RH)	84058339	2	1000200	4014486462388
18	GRAIN ELEVATOR, DRIVE	87319821	1	1004066	4014486519396
19	FAN VARI-DRIVE	84817627	1	1001135	4014486497199
19	CLEANING FAN, FIXED SHOE, SIEVE FIXED	919739	1	1001136	4014486497205

NEW HOLLAND CR 980, CS 520



No.	Application	OEM - PN	Set	Optibelt AP-Nr.	EAN
2	STRAW ELEVATOR DRIVE 4HB	84072421	1	1002036	4014486491722
4	UNLOADING AUGER	87011585	1	1001636	4014486485844
5	MAIN DRIVE	87580097	1	1001978	4014486490954
6	CHOPPER DRIVE	84320963	1	1001646	4014486485981
7	BEATER DRIVE	87580099	1	1001627	4014486485660
8	BEATER DRIVE	86566287	1	1000532	4014486518818
9	SHAKER SHOE DRIVE - SELF-LEVELLING	84056913	2	1000265	4014486464207
10	CHOPPER DRIVE	84320963	1	1001646	4014486485981
12	DRIVE, ROTARY SCREEN AND FAN	445930	1	1002074	4014486475623
13	DRIVE, ROTARY SCREEN AND FAN	84057085	1	1000175	4014486462036
14	ALTERNATOR DRIVE	747177	1	1002582	4014486495638
16	FEEDER DRIVE	86589482	1	1001914	4014486489774
17	TAILINGS ELEVATORS, BOTTOM AUGER AND (RH)	84058339	2	1000200	4014486462388
18	GRAIN ELEVATOR, DRIVE	87319821	1	1004066	4014486519396
19	FAN VARI-DRIVE	84817627	1	1001135	4014486497199
19	CLEANING FAN, FIXED SHOE, SIEVE FIXED	919739	1	1001136	4014486497205
1	ALTERNATOR, WATERPUMP AND AIR COMPRESSOR	84817638	1	1003807	4014486483048
2	MAIN TRANSMISSION	84993120	1	1002011	4014486491418
5	CHOPPER DRIVE	84076421	1	1001705	4014486486827
6	CHOPPER DRIVE	84075955	1	1003347	4014486486285
7	GRASS SEED EQUIPMENT	84452153	1	1004044	4014486518313

NEW HOLLAND CS 520, CS 540

No.	Application	OEM - PN	Set	Optibelt AP-Nr.	EAN
8	GRASS SEED EQUIPMENT	84452112	1	1004114	4014486522891
9	ELEVATOR BOTTOM DRIVE GRAIN	80422731	1	1000696	4014486470772
10	FAN DRIVE VARIABLE SPEED	84073979	1	1001421	4014486459289
11	SHAKER SHOE DRIVE	84015531	1	1000601	4014486469332
12	STRAW WALKER DRIVE	84073276	1	1000340	4014486465877
13	DRUM DRIVE	84072772	1	1001237	4014486491913
13	DRUM DRIVE (LOW DRUM SPEED)	84072815	1	1001952	4014486490572
14	ROTARY SEPARATOR DRIVE AND SHAFT	84073933	1	1000566	4014486468731
15	DRUM DRIVE VARIABLE SPEED	84035748	1	1001316	4014486497892
16	STRAW ELEVATOR DRIVE 3HB	84982278	1	1001697	4014486486735
16	STRAW ELEVATOR DRIVE 2HB (FOR CS520 ONLY)	84991234	1	1001922	4014486489903
17	HEADER DRIVE ENGAGING IDLER (2HB ONLY)	84446792	1	1003326	4014486486087
18	AIR COMPRESSOR - BLOW-OFF SYSTEM	84061465	1	1002586	4014486495775
19	ROTARY SCREEN AND FAN	84989965	1	1000169	4014486461954
19	ROTARY SCREEN AND FAN	84061465	1	1002586	4014486495775
20	HYDROSTATIC PUMP DRIVE (NOT FOR CS660)	84607712	1	1001850	4014486488838
21	HYDRAULIC PUMP DRIVE	80427456	1	1003351	4014486464603
22	UNLOADING AUGER DRIVE	84991836	1	1000653	4014486470161
1	ALTERNATOR, WATERPUMP AND AIR COMPRESSOR	84817638	1	1003807	4014486483048
2	MAIN TRANSMISSION	84993120	1	1002011	4014486491418
5	CHOPPER DRIVE	84076421	1	1001705	4014486486827

NEW HOLLAND CS 540



6	CHOPPER DRIVE	84075955	1	1003347	4014486486285
7	GRASS SEED EQUIPMENT	84452153	1	1004044	4014486518313
8	GRASS SEED EQUIPMENT	84452112	1	1004114	4014486522891
9	ELEVATOR BOTTOM DRIVE GRAIN	80422731	1	1000696	4014486470772
10	FAN DRIVE VARIABLE SPEED	84073979	1	1001421	4014486459289
11	SHAKER SHOE DRIVE	84015531	1	1000601	4014486469332
12	STRAW WALKER DRIVE	84073276	1	1000340	4014486465877
13	DRUM DRIVE	84072772	1	1001237	4014486491913
13	DRUM DRIVE (LOW DRUM SPEED)	84072815	1	1001952	4014486490572
14	ROTARY SEPARATOR DRIVE AND SHAFT	84073933	1	1000566	4014486468731
15	DRUM DRIVE VARIABLE SPEED	84035748	1	1001316	4014486497892
16	STRAW ELEVATOR DRIVE 3HB	84982278	1	1001697	4014486486735
16	STRAW ELEVATOR DRIVE 2HB (NOT FOR CS520)	84981586	1	1001720	4014486487022
17	HEADER DRIVE ENGAGING IDLER (3HB ONLY/NOT CS520)	89817374	1	1001876	4014486489231
17	HEADER DRIVE ENGAGING IDLER (2HB ONLY)	84446792	1	1003326	4014486486087
18	AIR COMPRESSOR - BLOW-OFF SYSTEM	84061465	1	1002586	4014486495775
19	ROTARY SCREEN AND FAN	84989965	1	1000169	4014486461954
19	ROTARY SCREEN AND FAN	84061465	1	1002586	4014486495775
20	HYDROSTATIC PUMP DRIVE (NOT FOR CS660)	84607712	1	1001850	4014486488838
21	HYDRAULIC PUMP DRIVE	80427456	1	1003351	4014486464603
22	UNLOADING AUGER DRIVE	84991836	1	1000653	4014486470161

NEW HOLLAND CS 6050

No.	Application	OEM - PN	Set	Optibelt AP-Nr.	EAN
2	STRAW ELEVATOR DRIVE, 2HB	84981586	1	1001720	4014486487022
2	STRAW ELEVATOR DRIVE, 3HB	84991234	1	1001922	4014486489903
3	HEADER DRIVE ENGAGING IDLER 3HB ONLY	89817374	1	1001876	4014486489231
3	HEADER DRIVE ENGAGING IDLER 2HB ONLY	84446792	1	1003326	4014486486087
4	DRUM VARIATOR	84035748	1	1001316	4014486497892
5	GRAIN TANK DISCHARGE	84462590	1	1000653	4014486470161
6	MAIN DRIVE	84993120	1	1002011	4014486491418
7	HYDROSTATIC PUMP DRIVE	80427456	1	1003351	4014486464603
8	HYDROSTATIC PUMP DRIVE	84607712	1	1001850	4014486488838
9	STRAW WALKER DRIVE	87521887	1	1000341	4014486465884
10	GRAIN ELEVATOR BOTTOM AUGER	80422731	1	1000696	4014486470772
13	CHOPPER DRIVE	84075955	1	1003347	4014486486285
14	CHOPPER DRIVE	84076421	1	1001705	4014486486827
15	DRIVE, ROTARY SCREEN AND FAN	84061465	1	1002586	4014486495775
16	DRIVE, ROTARY SCREEN AND FAN	84989965	1	1000169	4014486461954
17	ALTERNATOR DRIVE	747177	1	1002582	4014486495638
18	DRUM DRIVE	84072772	1	1001237	4014486491913
18	DRUM DRIVE, ROTATION SPEED SLOW	84072815	1	1001952	4014486490572
19	STRAW SHAKER DRIVE	84817635	1	1000601	4014486469332
20	FAN VARI-DRIVE	84073979	1	1001421	4014486459289
21	ROTARY SEPARATOR DRIVE AND SHAFT	84073933	1	1000566	4014486468731
22	CHOPPER DRIVE	84075955	1	1003347	4014486486285

NEW HOLLAND CS 6050, CS 6070



23	CHOPPER DRIVE	84076421	1	1001705	4014486486827
2	STRAW ELEVATOR DRIVE, 2HB	84981586	1	1001720	4014486487022
2	STRAW ELEVATOR DRIVE, 3HB	84991234	1	1001922	4014486489903
3	HEADER DRIVE ENGAGING IDLER 3HB ONLY	89817374	1	1001876	4014486489231
3	HEADER DRIVE ENGAGING IDLER 2HB ONLY	84446792	1	1003326	4014486486087
4	DRUM VARIATOR	84035748	1	1001316	4014486497892
5	GRAIN TANK DISCHARGE	84462590	1	1000653	4014486470161
6	MAIN DRIVE	84993120	1	1002011	4014486491418
7	HYDROSTATIC PUMP DRIVE	80427456	1	1003351	4014486464603
8	HYDROSTATIC PUMP DRIVE	84607712	1	1001850	4014486488838
9	STRAW WALKER DRIVE	87521887	1	1000341	4014486465884
10	GRAIN ELEVATOR BOTTOM AUGER	80422731	1	1000696	4014486470772
13	CHOPPER DRIVE	84075955	1	1003347	4014486486285
14	CHOPPER DRIVE	84076421	1	1001705	4014486486827
15	DRIVE, ROTARY SCREEN AND FAN	84061465	1	1002586	4014486495775
16	DRIVE, ROTARY SCREEN AND FAN	84989965	1	1000169	4014486461954
17	ALTERNATOR DRIVE	747177	1	1002582	4014486495638
18	DRUM DRIVE	84072772	1	1001237	4014486491913
18	DRUM DRIVE, ROTATION SPEED SLOW	84072815	1	1001952	4014486490572
19	STRAW SHAKER DRIVE	84817635	1	1000601	4014486469332
20	FAN VARI-DRIVE	84073979	1	1001421	4014486459289

NEW HOLLAND CS 6070, CS 6080

No.	Application	OEM - PN	Set	Optibelt AP-Nr.	EAN
21	ROTARY SEPARATOR DRIVE AND SHAFT	84073933	1	1000566	4014486468731
22	CHOPPER DRIVE	84075955	1	1003347	4014486486285
23	CHOPPER DRIVE	84076421	1	1001705	4014486486827
2	STRAW ELEVATOR DRIVE, 2HB	84981586	1	1001720	4014486487022
2	STRAW ELEVATOR DRIVE, 3HB	84991234	1	1001922	4014486489903
3	HEADER DRIVE ENGAGING IDLER 3HB ONLY	89817374	1	1001876	4014486489231
3	HEADER DRIVE ENGAGING IDLER 2HB ONLY	84446792	1	1003326	4014486486087
4	DRUM VARIATOR	84035748	1	1001316	4014486497892
5	GRAIN TANK DISCHARGE	84462590	1	1000653	4014486470161
6	MAIN DRIVE	84993120	1	1002011	4014486491418
7	HYDROSTATIC PUMP DRIVE	80427456	1	1003351	4014486464603
8	HYDROSTATIC PUMP DRIVE	84607712	1	1001850	4014486488838
9	STRAW WALKER DRIVE	87521887	1	1000341	4014486465884
10	GRAIN ELEVATOR BOTTOM AUGER	80422731	1	1000696	4014486470772
13	CHOPPER DRIVE	84075955	1	1003347	4014486486285
14	CHOPPER DRIVE	84076421	1	1001705	4014486486827
15	DRIVE, ROTARY SCREEN AND FAN	84061463	2	1004160	4014486523386
16	DRIVE, ROTARY SCREEN AND FAN	87374615	1	1004049	4014486518436
17	ALTERNATOR DRIVE	84817626	1	1002579	4014486495560
18	DRUM DRIVE	84072772	1	1001237	4014486491913
18	DRUM DRIVE, ROTATION SPEED SLOW	84072815	1	1001952	4014486490572

NEW HOLLAND CS 6080, CS 6090



19	STRAW SHAKER DRIVE	84817635	1	1000601	4014486469332
20	FAN VARI-DRIVE	84073979	1	1001421	4014486459289
21	ROTARY SEPARATOR DRIVE AND SHAFT	84073933	1	1000566	4014486468731
22	CHOPPER DRIVE	84075955	1	1003347	4014486486285
23	CHOPPER DRIVE	84076421	1	1001705	4014486486827
2	STRAW ELEVATOR DRIVE, 2HB	84981586	1	1001720	4014486487022
2	STRAW ELEVATOR DRIVE, 3HB	84991234	1	1001922	4014486489903
3	HEADER DRIVE ENGAGING IDLER 3HB ONLY	89817374	1	1001876	4014486489231
3	HEADER DRIVE ENGAGING IDLER 2HB ONLY	84446792	1	1003326	4014486486087
4	DRUM VARIATOR	84035748	1	1001316	4014486497892
5	GRAIN TANK DISCHARGE	84462590	1	1000653	4014486470161
6	MAIN DRIVE	84993120	1	1002011	4014486491418
7	HYDROSTATIC PUMP DRIVE	80427456	1	1003351	4014486464603
8	HYDROSTATIC PUMP DRIVE	84607713	1	1001853	4014486488876
9	STRAW WALKER DRIVE	87521887	1	1000341	4014486465884
10	GRAIN ELEVATOR BOTTOM AUGER	80422731	1	1000696	4014486470772
13	CHOPPER DRIVE	84075955	1	1003347	4014486486285
14	CHOPPER DRIVE	84076421	1	1001705	4014486486827
15	DRIVE, ROTARY SCREEN AND FAN	84061463	2	1004160	4014486523386
16	DRIVE, ROTARY SCREEN AND FAN	87374615	1	1004049	4014486518436
17	ALTERNATOR DRIVE	84817626	1	1002579	4014486495560

NEW HOLLAND CS 6090, CS 640

No.	Application	OEM - PN	Set	Optibelt AP-Nr.	EAN
18	DRUM DRIVE	84072772	1	1001237	4014486491913
18	DRUM DRIVE, ROTATION SPEED SLOW	84072815	1	1001952	4014486490572
19	STRAW SHAKER DRIVE	84817635	1	1000601	4014486469332
20	FAN VARI-DRIVE	84073979	1	1001421	4014486459289
21	ROTARY SEPARATOR DRIVE AND SHAFT	84073933	1	1000566	4014486468731
22	CHOPPER DRIVE	84075955	1	1003347	4014486486285
23	CHOPPER DRIVE	84076421	1	1001705	4014486486827
1	ALTERNATOR, WATERPUMP AND AIR COMPRESSOR	84817638	1	1003807	4014486483048
2	MAIN TRANSMISSION	84993120	1	1002011	4014486491418
5	CHOPPER DRIVE	84076421	1	1001705	4014486486827
6	CHOPPER DRIVE	84075955	1	1003347	4014486486285
7	GRASS SEED EQUIPMENT	84452153	1	1004044	4014486518313
8	GRASS SEED EQUIPMENT	84452112	1	1004114	4014486522891
9	ELEVATOR BOTTOM DRIVE GRAIN	80422731	1	1000696	4014486470772
10	FAN DRIVE VARIABLE SPEED	84073979	1	1001421	4014486459289
11	SHAKER SHOE DRIVE	84015531	1	1000601	4014486469332
12	STRAW WALKER DRIVE	84073276	1	1000340	4014486465877
13	DRUM DRIVE	84072772	1	1001237	4014486491913
13	DRUM DRIVE (LOW DRUM SPEED)	84072815	1	1001952	4014486490572
14	ROTARY SEPARATOR DRIVE AND SHAFT	84073933	1	1000566	4014486468731
15	DRUM DRIVE VARIABLE SPEED	84035748	1	1001316	4014486497892

NEW HOLLAND CS 640, CS 660



16	STRAW ELEVATOR DRIVE 3HB	84982278	1	1001697	4014486486735
16	STRAW ELEVATOR DRIVE 2HB (NOT FOR CS520)	84981586	1	1001720	4014486487022
17	HEADER DRIVE ENGAGING IDLER (3HB ONLY/NOT CS520)	89817374	1	1001876	4014486489231
17	HEADER DRIVE ENGAGING IDLER (2HB ONLY)	84446792	1	1003326	4014486486087
18	AIR COMPRESSOR - BLOW-OFF SYSTEM	84061465	1	1002586	4014486495775
19	ROTARY SCREEN AND FAN	84989965	1	1000169	4014486461954
19	ROTARY SCREEN AND FAN	84061465	1	1002586	4014486495775
20	HYDROSTATIC PUMP DRIVE (NOT FOR CS660)	84607712	1	1001850	4014486488838
21	HYDRAULIC PUMP DRIVE	80427456	1	1003351	4014486464603
22	UNLOADING AUGER DRIVE	84991836	1	1000653	4014486470161
1	ALTERNATOR, WATERPUMP AND AIR COMPRESSOR	84817638	1	1003807	4014486483048
2	MAIN TRANSMISSION	84993120	1	1002011	4014486491418
5	CHOPPER DRIVE	84076421	1	1001705	4014486486827
6	CHOPPER DRIVE	84075955	1	1003347	4014486486285
7	GRASS SEED EQUIPMENT	84452153	1	1004044	4014486518313
8	GRASS SEED EQUIPMENT	84452112	1	1004114	4014486522891
9	ELEVATOR BOTTOM DRIVE GRAIN	80422731	1	1000696	4014486470772
10	FAN DRIVE VARIABLE SPEED	84073979	1	1001421	4014486459289
11	SHAKER SHOE DRIVE	84015531	1	1000601	4014486469332
12	STRAW WALKER DRIVE	84073276	1	1000340	4014486465877
13	DRUM DRIVE	84072772	1	1001237	4014486491913

NEW HOLLAND CS 660, CSX 7060



No.	Application	OEM - PN	Set	Optibelt AP-Nr.	EAN
13	DRUM DRIVE (LOW DRUM SPEED)	84072815	1	1001952	4014486490572
14	ROTARY SEPARATOR DRIVE AND SHAFT	84073933	1	1000566	4014486468731
15	DRUM DRIVE VARIABLE SPEED	84035748	1	1001316	4014486497892
16	STRAW ELEVATOR DRIVE 3HB	84982278	1	1001697	4014486486735
16	STRAW ELEVATOR DRIVE 2HB (NOT FOR CS520)	84981586	1	1001720	4014486487022
17	HEADER DRIVE ENGAGING IDLER (3HB ONLY/NOT CS520)	89817374	1	1001876	4014486489231
17	HEADER DRIVE ENGAGING IDLER (2HB ONLY)	84446792	1	1003326	4014486486087
18	AIR COMPRESSOR - BLOW-OFF SYSTEM	84061465	1	1002586	4014486495775
19	ROTARY SCREEN AND FAN	84989965	1	1000169	4014486461954
19	ROTARY SCREEN AND FAN	84061465	1	1002586	4014486495775
20	HYDROSTATIC PUMP DRIVE (FOR CS660 ONLY)	84607713	1	1001853	4014486488876
21	HYDRAULIC PUMP DRIVE	80427456	1	1003351	4014486464603
22	UNLOADING AUGER DRIVE	84991836	1	1000653	4014486470161
2	STRAW ELEVATOR DRIVE, 2HB	84981586	1	1001720	4014486487022
2	STRAW ELEVATOR DRIVE, 3HB	84991234	1	1001922	4014486489903
3	HEADER DRIVE ENGAGING IDLER 3HB ONLY	89817374	1	1001876	4014486489231
3	HEADER DRIVE ENGAGING IDLER 2HB ONLY	84446792	1	1003326	4014486486087
4	DRUM VARIATOR	84035748	1	1001316	4014486497892
5	GRAIN TANK DISCHARGE	84462590	1	1000653	4014486470161
6	MAIN DRIVE	84993120	1	1002011	4014486491418
7	HYDROSTATIC PUMP DRIVE	80427456	1	1003351	4014486464603

NEW HOLLAND CSX 7060, CSX 7080



BISO - Schrattecker
BIZON
CASE INTL. HARVESTER
CLAAS
DEUTZ-FAHR
DRONNING-BORG
FENDT
FORTSCHRITT
JOHN DEERE
KRONE
LAVERDA
MASSEY FERGUSON
NEW HOLLAND
ROSTSELMASH

8	HYDROSTATIC PUMP DRIVE	84607712	1	1001850	4014486488838
9	STRAW WALKER DRIVE	87521887	1	1000341	4014486465884
10	GRAIN ELEVATOR BOTTOM AUGER	80422731	1	1000696	4014486470772
13	CHOPPER DRIVE	84075955	1	1003347	4014486486285
14	CHOPPER DRIVE	84076421	1	1001705	4014486486827
15	DRIVE, ROTARY SCREEN AND FAN	84061463	2	1004160	4014486523386
16	DRIVE, ROTARY SCREEN AND FAN	87374615	1	1004049	4014486518436
17	ALTERNATOR DRIVE	84817626	1	1002579	4014486495560
18	DRUM DRIVE	84072772	1	1001237	4014486491913
18	DRUM DRIVE, ROTATION SPEED SLOW	84072815	1	1001952	4014486490572
19	STRAW SHAKER DRIVE	84817635	1	1000601	4014486469332
20	FAN VARI-DRIVE	84073979	1	1001421	4014486459289
21	ROTARY SEPARATOR DRIVE AND SHAFT	84073933	1	1000566	4014486468731
22	CHOPPER DRIVE	84075955	1	1003347	4014486486285
23	CHOPPER DRIVE	84076421	1	1001705	4014486486827
2	STRAW ELEVATOR DRIVE, 2HB	84981586	1	1001720	4014486487022
2	STRAW ELEVATOR DRIVE, 3HB	84991234	1	1001922	4014486489903
3	HEADER DRIVE ENGAGING IDLER 3HB ONLY	89817374	1	1001876	4014486489231
3	HEADER DRIVE ENGAGING IDLER 2HB ONLY	84446792	1	1003326	4014486486087
4	DRUM VARIATOR	84035748	1	1001316	4014486497892
5	GRAIN TANK DISCHARGE	84462590	1	1000653	4014486470161

NEW HOLLAND CSX 7080, CX 720

No.	Application	OEM - PN	Set	Optibelt AP-Nr.	EAN
6	MAIN DRIVE	84993120	1	1002011	4014486491418
7	HYDROSTATIC PUMP DRIVE	80427456	1	1003351	4014486464603
8	HYDROSTATIC PUMP DRIVE	84607713	1	1001853	4014486488876
9	STRAW WALKER DRIVE	87521887	1	1000341	4014486465884
10	GRAIN ELEVATOR BOTTOM AUGER	80422731	1	1000696	4014486470772
13	CHOPPER DRIVE	84075955	1	1003347	4014486486285
14	CHOPPER DRIVE	84076421	1	1001705	4014486486827
15	DRIVE, ROTARY SCREEN AND FAN	84061463	2	1004160	4014486523386
16	DRIVE, ROTARY SCREEN AND FAN	87374615	1	1004049	4014486518436
17	ALTERNATOR DRIVE	84817626	1	1002579	4014486495560
18	DRUM DRIVE	84072772	1	1001237	4014486491913
18	DRUM DRIVE, ROTATION SPEED SLOW	84072815	1	1001952	4014486490572
19	STRAW SHAKER DRIVE	84817635	1	1000601	4014486469332
20	FAN VARI-DRIVE	84073979	1	1001421	4014486459289
21	ROTARY SEPARATOR DRIVE AND SHAFT	84073933	1	1000566	4014486468731
22	CHOPPER DRIVE	84075955	1	1003347	4014486486285
23	CHOPPER DRIVE	84076421	1	1001705	4014486486827
1	BEATER DRIVE	84045256	1	1000638	4014486469950
3	UNLOADING AUGER	84061293	1	1001634	4014486485820
4	MAIN DRIVE	84057914	1	1003844	4014486490893
5	CHOPPER DRIVE	84075345	1	1001636	4014486485844

NEW HOLLAND CX 720



BISO - Schrattecker
BIZON
CASE INTL. HARVESTER
CLAAS
DEUTZ-FAHR
DRONNING-BORG
FENDT
FORTSCHRITT
JOHN DEERE
KRONE
LAVERDA
MASSEY FERGUSON
NEW HOLLAND
ROSTSELMASH

6	CHOPPER DRIVE	84075635	1	1001687	4014486486612
7	INTERMEDIATE SHAFT FOR CLEANING DRIVE, WITH SLOPE COMPENSATION	84057392	1	1003337	4014486484847
8	SHAKER SHOE DRIVE, FIXED SHOE, WITHOUT SLOPE COMPENSATION	84432785	1	1000680	4014486470543
9	STRAW WALKER DRIVE	84057482	1	1000400	4014486466638
10	SHAKER SHOE AND TAILINGS ELEVATOR DRIVE, WITH SLOPE COMPENSATION	84057874	1	1000699	4014486470826
11	TAILINGS ELEVATOR DRIVE, FIXED SHOE, WITHOUT SLOPE COMPENSATION	84435035	1	1001644	4014486485967
12	DRUM VARIATOR	84035748	1	1001316	4014486497892
13	SHAKER SHOE DRIVE - SELF-LEVELLING	84056913	2	1000265	4014486464207
14	DRUM DRIVE	84061615	1	1001884	4014486489408
15	HEADER, DRIVE 3HB	84061279	1	1001880	4014486489309
16	DRIVE, ROTARY SCREEN AND FAN, FOR HIGH SPEED ONLY	84057085	1	1000175	4014486462036
18	BLOW-OFF SYSTEM, AIR COMPRESSOR	84061465	1	1002586	4014486495775
19	DRIVE : ALTERNATOR, WATERPUMP AND AIR	84057710	1	1002690	4014486482959
20	GRAIN ELEVATOR , DRIVE	84073457	1	1000256	4014486464054
21	ROTARY SEPARATOR DRIVE AND SHAFT, -> C415	84057393	1	1001581	4014486484885
21	ROTARY SEPARATOR DRIVE AND SHAFT, D416 ->	84457079	1	1001583	4014486484908
24	TAILINGS ELEVATORS, BOTTOM AUGER AND (RH)DRIVE	84058339	2	1000200	4014486462388
25	FAN VARI-DRIVE FOR SELF-LEVELLING ONLY	84817627	1	1001135	4014486497199
25	FAN VARI-DRIVE FOR FIXED SHOE ONLY	919739	1	1001136	4014486497205
22-23	DRIVE STRAW ELEVATOR 4HB	84334995	1	1002037	4014486491739

NEW HOLLAND CX 740

No.	Application	OEM - PN	Set	Optibelt AP-Nr.	EAN
1	BEATER DRIVE	84045256	1	1000638	4014486469950
3	UNLOADING AUGER	84061293	1	1001634	4014486485820
4	MAIN DRIVE	84057914	1	1003844	4014486490893
5	CHOPPER DRIVE	84075345	1	1001636	4014486485844
6	CHOPPER DRIVE	84075635	1	1001687	4014486486612
7	INTERMEDIATE SHAFT FOR CLEANING DRIVE, WITH SLOPE COMPENSATION	84057392	1	1003337	4014486484847
8	SHAKER SHOE DRIVE, FIXED SHOE, WITHOUT SLOPE COMPENSATION	84432785	1	1000680	4014486470543
9	STRAW WALKER DRIVE	84057482	1	1000400	4014486466638
10	SHAKER SHOE AND TAILINGS ELEVATOR DRIVE, WITH SLOPE COMPENSATION	84057874	1	1000699	4014486470826
11	TAILINGS ELEVATOR DRIVE, FIXED SHOE, WITHOUT SLOPE COMPENSATION	84435035	1	1001644	4014486485967
12	DRUM VARIATOR	84035748	1	1001316	4014486497892
13	SHAKER SHOE DRIVE - SELF-LEVELLING	84056913	2	1000265	4014486464207
14	DRUM DRIVE	84061615	1	1001884	4014486489408
15	HEADER, DRIVE 3HB	84061279	1	1001880	4014486489309
16	DRIVE, ROTARY SCREEN AND FAN	84057085	1	1000175	4014486462036
18	BLOW-OFF SYSTEM, AIR COMPRESSOR	84061465	1	1002586	4014486495775
19	DRIVE : ALTERNATOR, WATERPUMP AND AIR	84057710	1	1002690	4014486482959
20	GRAIN ELEVATOR , DRIVE	84073457	1	1000256	4014486464054
21	ROTARY SEPARATOR DRIVE AND SHAFT, -> C415	84057393	1	1001581	4014486484885
21	ROTARY SEPARATOR DRIVE AND SHAFT, D416 ->	84457079	1	1001583	4014486484908
24	TAILINGS ELEVATORS, BOTTOM AUGER AND (RH)DRIVE	84058339	2	1000200	4014486462388
25	FAN VARI-DRIVE FOR SELF-LEVELLING ONLY	84817627	1	1001135	4014486497199

NEW HOLLAND CX 740, CX 760



25	FAN VARI-DRIVE FOR FIXED SHOE ONLY	919739	1	1001136	4014486497205
22-23	DRIVE STRAW ELEVATOR 4HB	84334995	1	1002037	4014486491739
1	BEATER DRIVE	84045256	1	1000638	4014486469950
3	UNLOADING AUGER	84061293	1	1001634	4014486485820
4	MAIN DRIVE	84057914	1	1003844	4014486490893
5	CHOPPER DRIVE	84075345	1	1001636	4014486485844
6	CHOPPER DRIVE	84075635	1	1001687	4014486486612
7	INTERMEDIATE SHAFT FOR CLEANING DRIVE, WITH SLOPE COMPENSATION	84057392	1	1003337	4014486484847
8	SHAKER SHOE DRIVE, FIXED SHOE, WITHOUT SLOPE COMPENSATION	84432785	1	1000680	4014486470543
9	STRAW WALKER DRIVE	84057482	1	1000400	4014486466638
10	SHAKER SHOE AND TAILINGS ELEVATOR DRIVE, WITH SLOPE COMPENSATION	84057874	1	1000699	4014486470826
11	TAILINGS ELEVATOR DRIVE, FIXED SHOE, WITHOUT SLOPE COMPENSATION	84435035	1	1001644	4014486485967
12	DRUM VARIATOR	84035748	1	1001316	4014486497892
13	SHAKER SHOE DRIVE - SELF-LEVELLING	84056913	2	1000265	4014486464207
14	DRUM DRIVE	84061615	1	1001884	4014486489408
15	HEADER, DRIVE 3HB	84061279	1	1001880	4014486489309
16	DRIVE, ROTARY SCREEN AND FAN	84057085	1	1000175	4014486462036
18	BLOW-OFF SYSTEM, AIR COMPRESSOR	84061465	1	1002586	4014486495775
19	DRIVE : ALTERNATOR, WATERPUMP AND AIR	84057710	1	1002690	4014486482959
20	GRAIN ELEVATOR , DRIVE	84073457	1	1000256	4014486464054
21	ROTARY SEPARATOR DRIVE AND SHAFT, -> C415	84057393	1	1001581	4014486484885

NEW HOLLAND CX 760, CX 780

No.	Application	OEM - PN	Set	Optibelt AP-Nr.	EAN
21	ROTARY SEPARATOR DRIVE AND SHAFT, D416 ->	84457079	1	1001583	4014486484908
24	TAILINGS ELEVATORS, BOTTOM AUGER AND (RH)DRIVE	84058339	2	1000200	4014486462388
25	FAN VARI-DRIVE FOR SELF-LEVELLING ONLY	84817627	1	1001135	4014486497199
25	FAN VARI-DRIVE FOR FIXED SHOE ONLY	919739	1	1001136	4014486497205
22-23	DRIVE STRAW ELEVATOR 4HB	84334995	1	1002037	4014486491739
1	BEATER DRIVE	84045256	1	1000638	4014486469950
3	UNLOADING AUGER	84061293	1	1001634	4014486485820
4	MAIN DRIVE	84057914	1	1003844	4014486490893
5	CHOPPER DRIVE	84075345	1	1001636	4014486485844
6	CHOPPER DRIVE	84075635	1	1001687	4014486486612
7	INTERMEDIATE SHAFT FOR CLEANING DRIVE, WITH SLOPE COMPENSATION	84057392	1	1003337	4014486484847
8	SHAKER SHOE DRIVE, FIXED SHOE, WITHOUT SLOPE COMPENSATION	84432785	1	1000680	4014486470543
9	STRAW WALKER DRIVE	84057482	1	1000400	4014486466638
10	SHAKER SHOE AND TAILINGS ELEVATOR DRIVE, WITH SLOPE COMPENSATION	84057874	1	1000699	4014486470826
11	TAILINGS ELEVATOR DRIVE, FIXED SHOE, WITHOUT SLOPE COMPENSATION	84435035	1	1001644	4014486485967
12	DRUM VARIATOR	84035748	1	1001316	4014486497892
13	SHAKER SHOE DRIVE - SELF-LEVELLING	84056913	2	1000265	4014486464207
14	DRUM DRIVE	84061615	1	1001884	4014486489408
15	HEADER, DRIVE 3HB	84061279	1	1001880	4014486489309
16	DRIVE, ROTARY SCREEN AND FAN	84057085	1	1000175	4014486462036
18	BLOW-OFF SYSTEM, AIR COMPRESSOR	84061465	1	1002586	4014486495775

NEW HOLLAND CX 780, CX 8030



19	DRIVE : ALTERNATOR, WATERPUMP AND AIR	84057710	1	1002690	4014486482959
20	GRAIN ELEVATOR , DRIVE	84073457	1	1000256	4014486464054
21	ROTARY SEPARATOR DRIVE AND SHAFT, -> C415	84057393	1	1001581	4014486484885
21	ROTARY SEPARATOR DRIVE AND SHAFT, D416 ->	84457079	1	1001583	4014486484908
24	TAILINGS ELEVATORS, BOTTOM AUGER AND (RH)DRIVE	84058339	2	1000200	4014486462388
25	FAN VARI-DRIVE FOR SELF-LEVELLING ONLY	84817627	1	1001135	4014486497199
25	FAN VARI-DRIVE FOR FIXED SHOE ONLY	919739	1	1001136	4014486497205
22-23	DRIVE STRAW ELEVATOR 4HB	84334995	1	1002037	4014486491739
1	BEATER DRIVE	84045256	1	1000638	4014486469950
3	UNLOADING AUGER	84061293	1	1001634	4014486485820
4	MAIN DRIVE	84057914	1	1003844	4014486490893
5	CHOPPER DRIVE	84075345	1	1001636	4014486485844
6	CHOPPER DRIVE	87339998	1	1004042	4014486519464
7	INTERMEDIATE SHAFT FOR CLEANING DRIVE, WITH SLOPE COMPENSATION	84057392	1	1003337	4014486484847
8	SHAKER SHOE DRIVE, FIXED SHOE, WITHOUT SLOPE COMPENSATION	84432785	1	1000680	4014486470543
9	STRAW WALKER DRIVE	84057482	1	1000400	4014486466638
10	SHAKER SHOE AND TAILINGS ELEVATOR DRIVE, WITH SLOPE COMPENSATION	84057874	1	1000699	4014486470826
11	TAILINGS ELEVATOR DRIVE, FIXED SHOE, WITHOUT SLOPE COMPENSATION	84435035	1	1001644	4014486485967
12	DRUM VARIATOR	84035748	1	1001316	4014486497892
13	SHAKER SHOE DRIVE - SELF-LEVELLING	84056913	2	1000265	4014486464207
14	DRUM DRIVE WITHOUT REDUCTOR	84061615	1	1001884	4014486489408

NEW HOLLAND CX 8030, CX 8040

No.	Application	OEM - PN	Set	Optibelt AP-Nr.	EAN
15	HEADER, DRIVE 3HB	84061279	1	1001880	4014486489309
16	DRIVE, ROTARY SCREEN AND FAN	84057085	1	1000175	4014486462036
18	DRIVE, ROTARY SCREEN AND FAN	84061465	1	1002586	4014486495775
19	DRIVE : ALTERNATOR, WATERPUMP AND AIR	84057710	1	1002690	4014486482959
20	GRAIN ELEVATOR , DRIVE	84073457	1	1000256	4014486464054
21	ROTARY SEPARATOR DRIVE AND SHAFT	84457079	1	1001583	4014486484908
24	TAILINGS ELEVATORS, BOTTOM AUGER AND (RH)	84058339	2	1000200	4014486462388
25	FAN VARI-DRIVE FOR SELF-LEVELLING ONLY	84817627	1	1001135	4014486497199
25	FAN VARI-DRIVE FOR FIXED SHOE ONLY	919739	1	1001136	4014486497205
22-23	DRIVE STRAW ELEVATOR 4HB	84334995	1	1002037	4014486491739
1	BEATER DRIVE	84045256	1	1000638	4014486469950
3	UNLOADING AUGER	84061293	1	1001634	4014486485820
4	MAIN DRIVE	84057914	1	1003844	4014486490893
5	CHOPPER DRIVE	84075345	1	1001636	4014486485844
6	CHOPPER DRIVE	87339998	1	1004042	4014486519464
7	INTERMEDIATE SHAFT FOR CLEANING DRIVE, WITH SLOPE COMPENSATION	84057392	1	1003337	4014486484847
8	SHAKER SHOE DRIVE, FIXED SHOE, WITHOUT SLOPE COMPENSATION	84432785	1	1000680	4014486470543
9	STRAW WALKER DRIVE	84057482	1	1000400	4014486466638
10	SHAKER SHOE AND TAILINGS ELEVATOR DRIVE, WITH SLOPE COMPENSATION	84057874	1	1000699	4014486470826
11	TAILINGS ELEVATOR DRIVE, FIXED SHOE, WITHOUT SLOPE COMPENSATION	84435035	1	1001644	4014486485967
12	DRUM VARIATOR	84035748	1	1001316	4014486497892

NEW HOLLAND CX 8040, CX 8050



13	SHAKER SHOE DRIVE - SELF-LEVELLING	84056913	2	1000265	4014486464207
14	DRUM DRIVE WITHOUT REDUCTOR	84061615	1	1001884	4014486489408
15	HEADER, DRIVE 3HB	84061279	1	1001880	4014486489309
16	DRIVE, ROTARY SCREEN AND FAN	84057085	1	1000175	4014486462036
18	DRIVE, ROTARY SCREEN AND FAN	84061465	1	1002586	4014486495775
19	DRIVE : ALTERNATOR, WATERPUMP AND AIR	84057710	1	1002690	4014486482959
20	GRAIN ELEVATOR , DRIVE	84073457	1	1000256	4014486464054
21	ROTARY SEPARATOR DRIVE AND SHAFT	84457079	1	1001583	4014486484908
24	TAILINGS ELEVATORS, BOTTOM AUGER AND (RH)	84058339	2	1000200	4014486462388
25	FAN VARI-DRIVE FOR SELF-LEVELLING ONLY	84817627	1	1001135	4014486497199
25	FAN VARI-DRIVE FOR FIXED SHOE ONLY	919739	1	1001136	4014486497205
22-23	DRIVE STRAW ELEVATOR 4HB	84334995	1	1002037	4014486491739
1	BEATER DRIVE	84045256	1	1000638	4014486469950
3	UNLOADING AUGER	84061293	1	1001634	4014486485820
4	MAIN DRIVE	84057914	1	1003844	4014486490893
5	CHOPPER DRIVE	84075345	1	1001636	4014486485844
6	CHOPPER DRIVE	87339998	1	1004042	4014486519464
7	INTERMEDIATE SHAFT FOR CLEANING DRIVE, WITH SLOPE COMPENSATION	84057392	1	1003337	4014486484847
8	SHAKER SHOE DRIVE, FIXED SHOE, WITHOUT SLOPE COMPENSATION	84432785	1	1000680	4014486470543
9	STRAW WALKER DRIVE	84057482	1	1000400	4014486466638
10	SHAKER SHOE AND TAILINGS ELEVATOR DRIVE, WITH SLOPE COMPENSATION	84057874	1	1000699	4014486470826

NEW HOLLAND CX 8050, CX 8060



No.	Application	OEM - PN	Set	Optibelt AP-Nr.	EAN
11	TAILINGS ELEVATOR DRIVE, FIXED SHOE, WITHOUT SLOPE COMPENSATION	84435035	1	1001644	4014486485967
12	DRUM VARIATOR	84035748	1	1001316	4014486497892
13	SHAKER SHOE DRIVE - SELF-LEVELLING	84056913	2	1000265	4014486464207
14	DRUM DRIVE WITHOUT REDUCTOR	84061615	1	1001884	4014486489408
15	HEADER, DRIVE 3HB	84061279	1	1001880	4014486489309
16	DRIVE, ROTARY SCREEN AND FAN	84057085	1	1000175	4014486462036
18	DRIVE, ROTARY SCREEN AND FAN	84061465	1	1002586	4014486495775
19	DRIVE : ALTERNATOR, WATERPUMP AND AIR	84057710	1	1002690	4014486482959
20	GRAIN ELEVATOR , DRIVE	84073457	1	1000256	4014486464054
21	ROTARY SEPARATOR DRIVE AND SHAFT	84457079	1	1001583	4014486484908
24	TAILINGS ELEVATORS, BOTTOM AUGER AND (RH)	84058339	2	1000200	4014486462388
25	FAN VARI-DRIVE FOR SELF-LEVELLING ONLY	84817627	1	1001135	4014486497199
25	FAN VARI-DRIVE FOR FIXED SHOE ONLY	919739	1	1001136	4014486497205
22-23	DRIVE STRAW ELEVATOR 4HB	84334995	1	1002037	4014486491739
1	BEATER DRIVE	84045256	1	1000638	4014486469950
3	UNLOADING AUGER	84061293	1	1001634	4014486485820
4	MAIN DRIVE	84057914	1	1003844	4014486490893
5	CHOPPER DRIVE	84075345	1	1001636	4014486485844
6	CHOPPER DRIVE	87339998	1	1004042	4014486519464
7	INTERMEDIATE SHAFT FOR CLEANING DRIVE, WITH SLOPE COMPENSATION	84057392	1	1003337	4014486484847
8	SHAKER SHOE DRIVE, FIXED SHOE, WITHOUT SLOPE COMPENSATION	84432785	1	1000680	4014486470543

NEW HOLLAND CX 8060, CX 8080



9	STRAW WALKER DRIVE	84057482	1	1000400	4014486466638
10	SHAKER SHOE AND TAILINGS ELEVATOR DRIVE, WITH SLOPE COMPENSATION	84057874	1	1000699	4014486470826
11	TAILINGS ELEVATOR DRIVE, FIXED SHOE, WITHOUT SLOPE COMPENSATION	84435035	1	1001644	4014486485967
12	DRUM VARIATOR	84035748	1	1001316	4014486497892
13	SHAKER SHOE DRIVE - SELF-LEVELLING	84056913	2	1000265	4014486464207
14	DRUM DRIVE WITHOUT REDUCTOR	84061615	1	1001884	4014486489408
15	HEADER, DRIVE 3HB	84061279	1	1001880	4014486489309
16	DRIVE, ROTARY SCREEN AND FAN	84057085	1	1000175	4014486462036
18	DRIVE, ROTARY SCREEN AND FAN	84061465	1	1002586	4014486495775
19	DRIVE : ALTERNATOR, WATERPUMP AND AIR	84057710	1	1002690	4014486482959
20	GRAIN ELEVATOR , DRIVE	84073457	1	1000256	4014486464054
21	ROTARY SEPARATOR DRIVE AND SHAFT	84457079	1	1001583	4014486484908
24	TAILINGS ELEVATORS, BOTTOM AUGER AND (RH)	84058339	2	1000200	4014486462388
25	FAN VARI-DRIVE FOR SELF-LEVELLING ONLY	84817627	1	1001135	4014486497199
25	FAN VARI-DRIVE FOR FIXED SHOE ONLY	919739	1	1001136	4014486497205
22-23	DRIVE STRAW ELEVATOR 4HB	84334995	1	1002037	4014486491739
1	BEATER DRIVE	84045256	1	1000638	4014486469950
3	UNLOADING AUGER	84061293	1	1001634	4014486485820
4	MAIN DRIVE	84057914	1	1003844	4014486490893
5	CHOPPER DRIVE	84075345	1	1001636	4014486485844
6	CHOPPER DRIVE	87339998	1	1004042	4014486519464

NEW HOLLAND CX 8080, CX 8090



No.	Application	OEM - PN	Set	Optibelt AP-Nr.	EAN
7	INTERMEDIATE SHAFT FOR CLEANING DRIVE, WITH SLOPE COMPENSATION	84057392	1	1003337	4014486484847
8	SHAKER SHOE DRIVE, FIXED SHOE, WITHOUT SLOPE COMPENSATION	84432785	1	1000680	4014486470543
9	STRAW WALKER DRIVE	84057482	1	1000400	4014486466638
10	SHAKER SHOE AND TAILINGS ELEVATOR DRIVE, WITH SLOPE COMPENSATION	84057874	1	1000699	4014486470826
11	TAILINGS ELEVATOR DRIVE, FIXED SHOE, WITHOUT SLOPE COMPENSATION	84435035	1	1001644	4014486485967
12	DRUM VARIATOR	84035748	1	1001316	4014486497892
13	SHAKER SHOE DRIVE - SELF-LEVELLING	84056913	2	1000265	4014486464207
14	DRUM DRIVE WITHOUT REDUCTOR	84061615	1	1001884	4014486489408
15	HEADER, DRIVE 3HB	84061279	1	1001880	4014486489309
16	DRIVE, ROTARY SCREEN AND FAN	84057085	1	1000175	4014486462036
18	DRIVE, ROTARY SCREEN AND FAN	84061465	1	1002586	4014486495775
19	DRIVE : ALTERNATOR, WATERPUMP AND AIR	84057710	1	1002690	4014486482959
20	GRAIN ELEVATOR , DRIVE	84073457	1	1000256	4014486464054
21	ROTARY SEPARATOR DRIVE AND SHAFT	84457079	1	1001583	4014486484908
24	TAILINGS ELEVATORS, BOTTOM AUGER AND (RH)	84058339	2	1000200	4014486462388
25	FAN VARI-DRIVE FOR SELF-LEVELLING ONLY	84817627	1	1001135	4014486497199
25	FAN VARI-DRIVE FOR FIXED SHOE ONLY	919739	1	1001136	4014486497205
22-23	DRIVE STRAW ELEVATOR 4HB	84334995	1	1002037	4014486491739
1	BEATER DRIVE	84045256	1	1000638	4014486469950
3	UNLOADING AUGER	84061293	1	1001634	4014486485820
4	MAIN DRIVE	84057914	1	1003844	4014486490893

NEW HOLLAND CX 8090



5	CHOPPER DRIVE	84075345	1	1001636	4014486485844
6	CHOPPER DRIVE	87339998	1	1004042	4014486519464
7	INTERMEDIATE SHAFT FOR CLEANING DRIVE, WITH SLOPE COMPENSATION	84057392	1	1003337	4014486484847
8	SHAKER SHOE DRIVE, FIXED SHOE, WITHOUT SLOPE COMPENSATION	84432785	1	1000680	4014486470543
9	STRAW WALKER DRIVE	84057482	1	1000400	4014486466638
10	SHAKER SHOE AND TAILINGS ELEVATOR DRIVE, WITH SLOPE COMPENSATION	84057874	1	1000699	4014486470826
11	TAILINGS ELEVATOR DRIVE, FIXED SHOE, WITHOUT SLOPE COMPENSATION	84435035	1	1001644	4014486485967
12	DRUM VARIATOR FOR CX8030, CX8040, CX8050, CX8060, CX8070, CX8080 ONLY	84035748	1	1001316	4014486497892
13	SHAKER SHOE DRIVE - SELF-LEVELLING	84056913	2	1000265	4014486464207
14	DRUM DRIVE WITHOUT REDUCTOR	84061615	1	1001884	4014486489408
15	HEADER, DRIVE 3HB	84061279	1	1001880	4014486489309
16	DRIVE, ROTARY SCREEN AND FAN	84057085	1	1000175	4014486462036
17	DRIVE, ROTARY SCREEN AND FAN	84459056	2	1004161	4014486523393
18	DRIVE, ROTARY SCREEN AND FAN	84061465	1	1002586	4014486495775
19	DRIVE : ALTERNATOR, WATERPUMP AND AIR	84057710	1	1002690	4014486482959
20	GRAIN ELEVATOR , DRIVE	84073457	1	1000256	4014486464054
21	ROTARY SEPARATOR DRIVE AND SHAFT	84457079	1	1001583	4014486484908
24	TAILINGS ELEVATORS, BOTTOM AUGER AND (RH)	84058339	2	1000200	4014486462388
25	FAN VARI-DRIVE FOR SELF-LEVELLING ONLY	84817627	1	1001135	4014486497199
25	FAN VARI-DRIVE FOR FIXED SHOE ONLY	919739	1	1001136	4014486497205
22-23	DRIVE STRAW ELEVATOR 4HB	84334995	1	1002037	4014486491739

NEW HOLLAND CX 820

No.	Application	OEM - PN	Set	Optibelt AP-Nr.	EAN
1	BEATER DRIVE	84045256	1	1000638	4014486469950
3	UNLOADING AUGER	84061293	1	1001634	4014486485820
4	MAIN DRIVE	84057914	1	1003844	4014486490893
5	CHOPPER DRIVE	84075345	1	1001636	4014486485844
6	CHOPPER DRIVE	84075635	1	1001687	4014486486612
7	INTERMEDIATE SHAFT FOR CLEANING DRIVE, WITH SLOPE COMPENSATION	84057392	1	1003337	4014486484847
8	SHAKER SHOE DRIVE, FIXED SHOE, WITHOUT SLOPE COMPENSATION	84432785	1	1000680	4014486470543
9	STRAW WALKER DRIVE	84057482	1	1000400	4014486466638
10	SHAKER SHOE AND TAILINGS ELEVATOR DRIVE, WITH SLOPE COMPENSATION	84057874	1	1000699	4014486470826
11	TAILINGS ELEVATOR DRIVE, FIXED SHOE, WITHOUT SLOPE COMPENSATION	84435035	1	1001644	4014486485967
12	DRUM VARIATOR	84035748	1	1001316	4014486497892
13	SHAKER SHOE DRIVE - SELF-LEVELLING	84056913	2	1000265	4014486464207
14	DRUM DRIVE	84061615	1	1001884	4014486489408
15	HEADER, DRIVE 3HB	84061279	1	1001880	4014486489309
16	DRIVE, ROTARY SCREEN AND FAN	84057085	1	1000175	4014486462036
18	BLOW-OFF SYSTEM, AIR COMPRESSOR	84061465	1	1002586	4014486495775
19	DRIVE : ALTERNATOR, WATERPUMP AND AIR	84057710	1	1002690	4014486482959
20	GRAIN ELEVATOR , DRIVE	84073457	1	1000256	4014486464054
21	ROTARY SEPARATOR DRIVE AND SHAFT, -> C415	84057393	1	1001581	4014486484885
21	ROTARY SEPARATOR DRIVE AND SHAFT, D416 ->	84457079	1	1001583	4014486484908
24	TAILINGS ELEVATORS, BOTTOM AUGER AND (RH)DRIVE	84058339	2	1000200	4014486462388
25	FAN VARI-DRIVE FOR SELF-LEVELLING ONLY	84817627	1	1001135	4014486497199

NEW HOLLAND CX 820, CX 840



25	FAN VARI-DRIVE FOR FIXED SHOE ONLY	919739	1	1001136	4014486497205
22-23	DRIVE STRAW ELEVATOR 4HB	84334995	1	1002037	4014486491739
2	GRASS SEED EQUIPMENT - ACCESSORIES FOR SELF LEVELLING ONLY	84023277	1	1001132	4014486497168
2	GRASS SEED EQUIPMENT - ACCESSORIES FOR FIXED SHOE ONLY	84023278	1	1001133	4014486497175
3	SHAKER SHOE DRIVE - SELF-LEVELLING	84056913	2	1000265	4014486464207
4	INTERMEDIATE SHAFT - CLEANING DRIVE	84057392	1	1003337	4014486484847
5	STRAW WALKER DRIVE	84057482	1	1000400	4014486466638
6	SHAKER SHOE AND TAILINGS ELEVATOR DRIVE - SELF LEVELLING	84057874	1	1000699	4014486470826
7	TAILINGS ELEVATORS - BOTTOM AUGER AND (RIGHT HAND) DRIVE	84058339	2	1000200	4014486462388
8	SHAKER SHOE DRIVE - FIXED SHOE	84432785	1	1000680	4014486470543
9	TAILINGS ELEVATOR DRIVE - FIXED SHOE	84435035	1	1001644	4014486485967
10	MAIN FAN VARIABLE SPEED DRIVE FOR SELF LEVELLING ONLY	9502654	1	1001135	4014486497199
10	MAIN FAN VARIABLE SPEED DRIVE FOR FIXED SHOE ONLY	919739	1	1001136	4014486497205
11	ROTARY SCREEN AND FAN	84057085	1	1000175	4014486462036
12	ALTERNATOR, WATERPUMP AND AIR COMPRESSOR	84057710	1	1002690	4014486482959
13	MAIN DRIVE	84057914	1	1003844	4014486490893
14	ROTARY SCREEN AND FAN	84061465	1	1002586	4014486495775
15	AIR COMPRESSOR - BLOW-OFF SYSTEM	84061465	1	1002586	4014486495775
17	ROTARY SCREEN AND FAN	9835816	1	1002588	4014486495812
18	HEADER DRIVE	84061279	1	1001880	4014486489309
19	STRAW ELEVATOR DRIVE	84334995	1	1002037	4014486491739

NEW HOLLAND CX 840, CX 860

No.	Application	OEM - PN	Set	Optibelt AP-Nr.	EAN
20	STRAW ELEVATOR DRIVE	84434260	1	1001714	4014486486940
21	STRAW ELEVATOR DRIVE	84434295	1	1001645	4014486485974
22	DRUM DRIVE VARIABLE SPEED	84035748	1	1001316	4014486497892
23	BEATER DRIVE	84045256	1	1000638	4014486469950
24	ROTARY SEPARATOR DRIVE AND SHAFT	84057393	1	1001581	4014486484885
25	DRUM DRIVE WITH REDUCTOR	84061615	1	1001884	4014486489408
26	DRUM DRIVE WITHOUT REDUCTOR	84061615	1	1001884	4014486489408
27	ROTARY SEPARATOR DRIVE AND SHAFT	84457079	1	1001583	4014486484908
28	UNLOADING AUGER DRIVE	84061293	1	1001634	4014486485820
29	ELEVATOR DRIVE GRAIN	84073457	1	1000256	4014486464054
1A	CHOPPER DRIVE	84075345	1	1001636	4014486485844
1B	CHOPPER DRIVE	84075635	1	1001687	4014486486612
2	GRASS SEED EQUIPMENT - ACCESSORIES FOR SELF LEVELLING ONLY	84023277	1	1001132	4014486497168
2	GRASS SEED EQUIPMENT - ACCESSORIES FOR FIXED SHOE ONLY	84023278	1	1001133	4014486497175
3	SHAKER SHOE DRIVE - SELF-LEVELLING	84056913	2	1000265	4014486464207
4	INTERMEDIATE SHAFT - CLEANING DRIVE	84057392	1	1003337	4014486484847
5	STRAW WALKER DRIVE	84057482	1	1000400	4014486466638
6	SHAKER SHOE AND TAILINGS ELEVATOR DRIVE - SELF LEVELLING	84057874	1	1000699	4014486470826
7	TAILINGS ELEVATORS - BOTTOM AUGER AND (RIGHT HAND) DRIVE	84058339	2	1000200	4014486462388
8	SHAKER SHOE DRIVE - FIXED SHOE	84432785	1	1000680	4014486470543
9	TAILINGS ELEVATOR DRIVE - FIXED SHOE	84435035	1	1001644	4014486485967

NEW HOLLAND CX 860



10	MAIN FAN VARIABLE SPEED DRIVE FOR SELF LEVELLING ONLY	9502654	1	1001135	4014486497199
10	MAIN FAN VARIABLE SPEED DRIVE FOR FIXED SHOE ONLY	919739	1	1001136	4014486497205
11	ROTARY SCREEN AND FAN	84057085	1	1000175	4014486462036
12	ALTERNATOR, WATERPUMP AND AIR COMPRESSOR	84057710	1	1002690	4014486482959
13	MAIN DRIVE	84057914	1	1003844	4014486490893
14	ROTARY SCREEN AND FAN	84061465	1	1002586	4014486495775
15	AIR COMPRESSOR - BLOW-OFF SYSTEM	84061465	1	1002586	4014486495775
18	HEADER DRIVE	84061279	1	1001880	4014486489309
19	STRAW ELEVATOR DRIVE	84334995	1	1002037	4014486491739
20	STRAW ELEVATOR DRIVE	84434260	1	1001714	4014486486940
21	STRAW ELEVATOR DRIVE	84434295	1	1001645	4014486485974
22	DRUM DRIVE VARIABLE SPEED	84035748	1	1001316	4014486497892
23	BEATER DRIVE	84045256	1	1000638	4014486469950
24	ROTARY SEPARATOR DRIVE AND SHAFT	84057393	1	1001581	4014486484885
25	DRUM DRIVE WITH REDUCTOR	84061615	1	1001884	4014486489408
26	DRUM DRIVE WITHOUT REDUCTOR	84061615	1	1001884	4014486489408
27	ROTARY SEPARATOR DRIVE AND SHAFT	84457079	1	1001583	4014486484908
28	UNLOADING AUGER DRIVE	84061293	1	1001634	4014486485820
29	ELEVATOR DRIVE GRAIN	84073457	1	1000256	4014486464054
1A	CHOPPER DRIVE	84075345	1	1001636	4014486485844
1B	CHOPPER DRIVE	84075635	1	1001687	4014486486612

NEW HOLLAND CX 880

No.	Application	OEM - PN	Set	Optibelt AP-Nr.	EAN
2	GRASS SEED EQUIPMENT - ACCESSORIES FOR SELF LEVELLING ONLY	84023277	1	1001132	4014486497168
2	GRASS SEED EQUIPMENT - ACCESSORIES FOR FIXED SHOE ONLY	84023278	1	1001133	4014486497175
3	SHAKER SHOE DRIVE - SELF-LEVELLING	84056913	2	1000265	4014486464207
4	INTERMEDIATE SHAFT - CLEANING DRIVE	84057392	1	1003337	4014486484847
5	STRAW WALKER DRIVE	84057482	1	1000400	4014486466638
6	SHAKER SHOE AND TAILINGS ELEVATOR DRIVE - SELF LEVELLING	84057874	1	1000699	4014486470826
7	TAILINGS ELEVATORS - BOTTOM AUGER AND (RIGHT HAND) DRIVE	84058339	2	1000200	4014486462388
8	SHAKER SHOE DRIVE - FIXED SHOE	84432785	1	1000680	4014486470543
9	TAILINGS ELEVATOR DRIVE - FIXED SHOE	84435035	1	1001644	4014486485967
10	MAIN FAN VARIABLE SPEED DRIVE FOR SELF LEVELLING ONLY	9502654	1	1001135	4014486497199
10	MAIN FAN VARIABLE SPEED DRIVE FOR FIXED SHOE ONLY	919739	1	1001136	4014486497205
11	ROTARY SCREEN AND FAN	84057085	1	1000175	4014486462036
12	ALTERNATOR, WATERPUMP AND AIR COMPRESSOR	84057710	1	1002690	4014486482959
13	MAIN DRIVE	84057914	1	1003844	4014486490893
14	ROTARY SCREEN AND FAN	84061465	1	1002586	4014486495775
15	AIR COMPRESSOR - BLOW-OFF SYSTEM	84061465	1	1002586	4014486495775
18	HEADER DRIVE	84061279	1	1001880	4014486489309
19	STRAW ELEVATOR DRIVE	84334995	1	1002037	4014486491739
20	STRAW ELEVATOR DRIVE	84434260	1	1001714	4014486486940
21	STRAW ELEVATOR DRIVE	84434295	1	1001645	4014486485974
22	DRUM DRIVE VARIABLE SPEED	84035748	1	1001316	4014486497892
23	BEATER DRIVE	84045256	1	1000638	4014486469950

NEW HOLLAND CX 880, FX 300, FX 375



24	ROTARY SEPARATOR DRIVE AND SHAFT	84057393	1	1001581	4014486484885
25	DRUM DRIVE WITH REDUCTOR	84061615	1	1001884	4014486489408
26	DRUM DRIVE WITHOUT REDUCTOR	84061615	1	1001884	4014486489408
27	ROTARY SEPARATOR DRIVE AND SHAFT	84457079	1	1001583	4014486484908
28	UNLOADING AUGER DRIVE	84061293	1	1001634	4014486485820
29	ELEVATOR DRIVE GRAIN	84073457	1	1000256	4014486464054
1A	CHOPPER DRIVE	84075345	1	1001636	4014486485844
1B	CHOPPER DRIVE	84075635	1	1001687	4014486486612
1	MAIN DRIVE	84017742	2	1001167	4014486491784
2	DRIVE	84026761	4	1002746	4014486461862
3	FAN DRIVE	84012975	2	1002087	4014486519129
4	ALTERNATOR DRIVE	84022807	1	1001132	4014486497168
5	COMPRESSOR DRIVE	80747177	1	1002582	4014486495638
1	MAIN DRIVE	84017742	2	1001167	4014486491784
2	DRIVE	84026761	4	1002746	4014486461862
3	FAN DRIVE	84012975	2	1002087	4014486519129
4	ALTERNATOR DRIVE	84022807	1	1001132	4014486497168
5	COMPRESSOR DRIVE	80747177	1	1002582	4014486495638

NEW HOLLAND FX 450, M 103, M 122

No.	Application	OEM - PN	Set	Optibelt AP-Nr.	EAN
1	MAIN DRIVE	84017742	2	1001167	4014486491784
2	DRIVE	84026761	4	1002746	4014486461862
3	FAN DRIVE	84012975	2	1002087	4014486519129
4	ALTERNATOR DRIVE	84022807	1	1001132	4014486497168
5	COMPRESSOR DRIVE	80747177	1	1002582	4014486495638
1	THRESHING DRUM VARIATOR DRIVE	80230078	1	1001509	4014486460254
8	REEL DRIVE INTERMEDIATE SHAFT - (LOWER)	80230057	1	1000603	4014486469370
10	REEL DRIVE	80230060	1	1003534	4014486470536
11	HYDRAULIC PUMP DRIVE	80230043	1	1003400	4014486462906
18	POWER STEERING	80230043	1	1003400	4014486462906
1	HYDRAULIC PUMP DRIVE	80230043	1	1003400	4014486462906
3	STRAW ELEVATOR DRIVE	80230059	1	1000654	4014486470178
12	CYLINDER	80230078	1	1001509	4014486460254
13	UNLOADING SYSTEM	80326298	1	1003489	4014486468427
14	FAN DRIVE	80330204	1	1000243	4014486463613
15	DEUTZ ENGINE	80327040	1	1002267	4014486478358

NEW HOLLAND M 133, M 135



BISO - Schrattecker
BIZON
CASE INTL. HARVESTER
CLAAS
DEUTZ-FAHR
DRONNING-BORG
FENDT
FORTSCHRITT
JOHN DEERE
KRONE
LAVERDA
MASSEY FERGUSON
NEW HOLLAND
ROSTSELMASH

No.	Application	OEM - PN	Set	Optibelt AP-Nr.	EAN
1	HYDRAULIC PUMP DRIVE	80230043	1	1003400	4014486462906
2	REEL DRIVE ECCENTRIC	80230060	1	1003534	4014486470536
12	TAILINGS ELEVATOR DRIVE	80230057	1	1000603	4014486469370
12	ELEVATOR DRIVE GRAIN	80230059	1	1000654	4014486470178
13	ELEVATOR DRIVE UNIT	80230059	1	1000654	4014486470178
14	CYLINDER	80230078	1	1001509	4014486460254
16	DISCHARGE AUGER SHAFT	80230103	1	1000881	4014486473216
17	STRAW WALKER DRIVE	80230108	1	1003452	4014486465617
18	FAN DRIVE	80336386	1	1000027	4014486483482
19	ALTERNATOR DRIVE	80336426	1	1000020	4014486483390
1	HYDRAULIC PUMP DRIVE	80230043	1	1003400	4014486462906
2	REEL DRIVE ECCENTRIC	80230060	1	1003534	4014486470536
12	TAILINGS ELEVATOR DRIVE	80230057	1	1000603	4014486469370
12	ELEVATOR DRIVE GRAIN	80230059	1	1000654	4014486470178
13	ELEVATOR DRIVE UNIT	80230059	1	1000654	4014486470178
14	CYLINDER	80230078	1	1001509	4014486460254
16	DISCHARGE AUGER SHAFT	80230103	1	1000881	4014486473216
17	STRAW WALKER DRIVE	80230108	1	1003452	4014486465617
18	FAN DRIVE	80336386	1	1000027	4014486483482
19	ALTERNATOR DRIVE	80336426	1	1000020	4014486483390

NEW HOLLAND M 140, M 80, M 89

No.	Application	OEM - PN	Set	Optibelt AP-Nr.	EAN
1	HYDRAULIC PUMP DRIVE	80230043	1	1003400	4014486462906
2	REEL DRIVE ECCENTRIC	80230060	1	1003534	4014486470536
12	TAILINGS ELEVATOR DRIVE	80230057	1	1000603	4014486469370
12	ELEVATOR DRIVE GRAIN	80230059	1	1000654	4014486470178
13	ELEVATOR DRIVE UNIT	80230059	1	1000654	4014486470178
14	CYLINDER	80230078	1	1001509	4014486460254
16	DISCHARGE AUGER SHAFT	80230103	1	1000881	4014486473216
17	STRAW WALKER DRIVE	80230108	1	1003452	4014486465617
18	FAN DRIVE	80336386	1	1000027	4014486483482
19	ALTERNATOR DRIVE	80336426	1	1000020	4014486483390
1	HYDRAULIC PUMP DRIVE	80230043	1	1003400	4014486462906
5	STRAW ELEVATOR DRIVE	80230059	1	1000654	4014486470178
6	REEL DRIVE	80230060	1	1003534	4014486470536
7	STICKLE KNIFE DRIVE	80230060	1	1003534	4014486470536
20	CYLINDER	80230078	1	1001509	4014486460254
1	HYDRAULIC PUMP DRIVE	80230043	1	1003400	4014486462906
3	STRAW ELEVATOR DRIVE	80230059	1	1000654	4014486470178
4	REEL DRIVE	80230060	1	1003534	4014486470536
5	STICKLE KNIFE DRIVE	80230060	1	1003534	4014486470536
16	CYLINDER	80230078	1	1001509	4014486460254

NEW HOLLAND TC 5040



No.	Application	OEM - PN	Set	Optibelt AP-Nr.	EAN
3	DRIVE, ROTARY SCREEN AND FAN	84989965	1	1000169	4014486461954
4	AIR CONDITIONING FAN DRIVE	9818704	1	1000074	4014486483949
4	INTERMEDIATE SHAFT DRIVE	87535206	1	1003727	4014486495164
7	UNLOADING AUGER DRIVE	84448591	1	1000657	4014486470215
8	HEADER DRIVE ENGAGING IDLER 3HB ONLY	89817374	1	1001876	4014486489231
9	UPPER GROUND SPEED	80356024	1	1001489	4014486459999
10	VARIATOR DRIVE	9850782	1	1001491	4014486460018
11	DRIVE GROUP FOR GRAIN AND TAILINGS ELEVATOR	80422731	1	1000696	4014486470772
12	ECCENTRIC SHAFT DRIVE	80387469	1	1000700	4014486470833
15	DRUM VARI-DRIVE CONTROL	336784	1	1001506	4014486460216
16	FAN VARI-DRIVE	9515075	1	1001428	4014486459364
17	FAN VARI-DRIVE	9515076	1	1001416	4014486459234
18	STRAW WALKER SHAFT	80431784	1	1000328	4014486465587
20	ROTARY SEPARATOR DRIVE	89837412	1	1000573	4014486468816
13-14	2HC DRIVE BESIDE STRAW ELEVATOR	84971217	1	1001782	4014486520385

NEW HOLLAND TC 5050



No.	Application	OEM - PN	Set	Optibelt AP-Nr.	EAN
3	DRIVE, ROTARY SCREEN AND FAN	84989965	1	1000169	4014486461954
4	AIR CONDITIONING FAN DRIVE	9818704	1	1000074	4014486483949
4	INTERMEDIATE SHAFT DRIVE	87535206	1	1003727	4014486495164
7	UNLOADING AUGER DRIVE	84448591	1	1000657	4014486470215
8	HEADER DRIVE ENGAGING IDLER 3HB ONLY	89817374	1	1001876	4014486489231
11	DRIVE GROUP FOR GRAIN AND TAILINGS ELEVATOR	80422731	1	1000696	4014486470772
12	ECCENTRIC SHAFT DRIVE	80387469	1	1000700	4014486470833
15	DRUM VARI-DRIVE CONTROL	336784	1	1001506	4014486460216
16	FAN VARI-DRIVE	9515075	1	1001428	4014486459364
17	FAN VARI-DRIVE	9515076	1	1001416	4014486459234
18	STRAW WALKER SHAFT	80431784	1	1000328	4014486465587
20	ROTARY SEPARATOR DRIVE	89837412	1	1000573	4014486468816
13-14	2HC DRIVE BESIDE STRAW ELEVATOR	84971217	1	1001782	4014486520385

NEW HOLLAND TC 5060



No.	Application	OEM - PN	Set	Optibelt AP-Nr.	EAN
3	DRIVE, ROTARY SCREEN AND FAN	84989965	1	1000169	4014486461954
4	AIR CONDITIONING FAN DRIVE	9818704	1	1000074	4014486483949
4	INTERMEDIATE SHAFT DRIVE	87535206	1	1003727	4014486495164
7	UNLOADING AUGER DRIVE	84448591	1	1000657	4014486470215
8	HEADER DRIVE ENGAGING IDLER 3HB ONLY	89817374	1	1001876	4014486489231
9	UPPER GROUND SPEED	80356024	1	1001489	4014486459999
10	VARIATOR DRIVE	9850782	1	1001491	4014486460018
11	DRIVE GROUP FOR GRAIN AND TAILINGS ELEVATOR	80422731	1	1000696	4014486470772
12	ECCENTRIC SHAFT DRIVE	80387469	1	1000700	4014486470833
15	DRUM VARI-DRIVE CONTROL	336784	1	1001506	4014486460216
16	FAN VARI-DRIVE	9515075	1	1001428	4014486459364
17	FAN VARI-DRIVE	9515076	1	1001416	4014486459234
18	STRAW WALKER SHAFT	80431784	1	1000328	4014486465587
20	ROTARY SEPARATOR DRIVE	89837412	1	1000573	4014486468816
13-14	2HC DRIVE BESIDE STRAW ELEVATOR	84971217	1	1001782	4014486520385

NEW HOLLAND TC 5070



No.	Application	OEM - PN	Set	Optibelt AP-Nr.	EAN
3	DRIVE, ROTARY SCREEN AND FAN	84989965	1	1000169	4014486461954
4	AIR CONDITIONING FAN DRIVE	9818704	1	1000074	4014486483949
7	UNLOADING AUGER DRIVE	84448591	1	1000657	4014486470215
8	HEADER DRIVE ENGAGING IDLER 3HB ONLY	89817374	1	1001876	4014486489231
11	DRIVE GROUP FOR GRAIN AND TAILINGS ELEVATOR	80422731	1	1000696	4014486470772
12	ECCENTRIC SHAFT DRIVE	80387469	1	1000700	4014486470833
15	DRUM VARI-DRIVE CONTROL	336784	1	1001506	4014486460216
16	FAN VARI-DRIVE	9515075	1	1001428	4014486459364
17	FAN VARI-DRIVE	9515076	1	1001416	4014486459234
18	STRAW WALKER SHAFT	80431784	1	1000328	4014486465587
20	ROTARY SEPARATOR DRIVE	89837412	1	1000573	4014486468816
13-14	2HC DRIVE BESIDE STRAW ELEVATOR	84971217	1	1001782	4014486520385

NEW HOLLAND TC 5080



No.	Application	OEM - PN	Set	Optibelt AP-Nr.	EAN
3	DRIVE, ROTARY SCREEN AND FAN	84989965	1	1000169	4014486461954
4	AIR CONDITIONING FAN DRIVE	9818704	1	1000074	4014486483949
7	UNLOADING AUGER DRIVE	84448591	1	1000657	4014486470215
8	HEADER DRIVE ENGAGING IDLER 3HB ONLY	89817374	1	1001876	4014486489231
11	DRIVE GROUP FOR GRAIN AND TAILINGS ELEVATOR	80422731	1	1000696	4014486470772
12	ECCENTRIC SHAFT DRIVE	80387469	1	1000700	4014486470833
15	DRUM VARI-DRIVE CONTROL	336784	1	1001506	4014486460216
16	FAN VARI-DRIVE	9515075	1	1001428	4014486459364
17	FAN VARI-DRIVE	9515076	1	1001416	4014486459234
18	STRAW WALKER SHAFT	80431784	1	1000328	4014486465587
20	ROTARY SEPARATOR DRIVE	89837412	1	1000573	4014486468816
13-14	2HC DRIVE BESIDE STRAW ELEVATOR	84971217	1	1001782	4014486520385

NEW HOLLAND TC 52

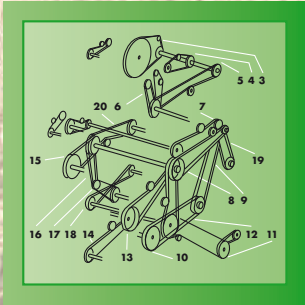

No.	Application	OEM - PN	Set	Optibelt AP-Nr.	EAN
3	ROTARY DUST SCREEN DRIVE	89514310	1	1000152	4014486461725
6	ALTERNATOR AND WATERPUMP DRIVE (WITHOUT AIR COMPRESSOR)	84005860	1	1002636	4014486480405
7	INTERMEDIATE SHAFT - ENGINE	89838606	1	1000654	4014486470178
8	BEATER SHAFT - MAIN DRIVE	89817374	1	1001876	4014486489231
11	AUGER (GRAIN)	80422731	1	1000696	4014486470772
12	BEATER SHAFT - ECCENTRIC SHAFT	80387469	1	1000700	4014486470833
13	STRAW ELEVATOR - BEATER SHAFT	80066232	1	1000690	4014486470697
13	STRAW ELEVATOR - BEATER SHAFT	80424563	1	1001765	4014486487480
14	HEADER DRIVE (CODE 1300) FOR L. CONV. TC52-54	89839375	1	1000774	4014486471830
14	HEADER DRIVE (CODE 0212) TC 52-54	89817488	1	1001780	4014486487671
14	HEADER DRIVE (CODE 1300) FOR L. CONV. TC52-54	89835120	1	1001781	4014486487688
15	DRUM - BEATER SHAFT	80336784	1	1001506	4014486460216
18	STRAW WALKER - ECCENTRIC SHAFT	80431784	1	1000328	4014486465587
20	ROTARY SEPARATOR (CODE 2300)	89837412	1	1000573	4014486468816

NEW HOLLAND TC 54

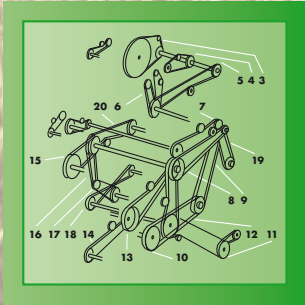

No.	Application	OEM - PN	Set	Optibelt AP-Nr.	EAN
3	ROTARY DUST SCREEN DRIVE	89514310	1	1000152	4014486461725
6	ALTERNATOR AND WATERPUMP DRIVE (WITHOUT AIR COMPRESSOR)	84005860	1	1002636	4014486480405
7	INTERMEDIATE SHAFT - ENGINE	89838606	1	1000654	4014486470178
8	BEATER SHAFT - MAIN DRIVE	89817374	1	1001876	4014486489231
11	AUGER (GRAIN)	80422731	1	1000696	4014486470772
12	BEATER SHAFT - ECCENTRIC SHAFT	80387469	1	1000700	4014486470833
13	STRAW ELEVATOR - BEATER SHAFT	80066232	1	1000690	4014486470697
13	STRAW ELEVATOR - BEATER SHAFT	80424563	1	1001765	4014486487480
14	HEADER DRIVE (CODE 1300) FOR L. CONV. TC52-54	89839375	1	1000774	4014486471830
14	HEADER DRIVE (CODE 0212) TC 52-54	89817488	1	1001780	4014486487671
14	HEADER DRIVE (CODE 1300) FOR L. CONV. TC52-54	89835120	1	1001781	4014486487688
15	DRUM - BEATER SHAFT	80336784	1	1001506	4014486460216
18	STRAW WALKER - ECCENTRIC SHAFT	80431784	1	1000328	4014486465587
20	ROTARY SEPARATOR (CODE 2300)	89837412	1	1000573	4014486468816

NEW HOLLAND TC 56

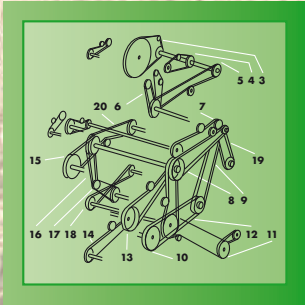

No.	Application	OEM - PN	Set	Optibelt AP-Nr.	EAN
3	ROTARY DUST SCREEN DRIVE	89514310	1	1000152	4014486461725
6	ALTERNATOR AND WATERPUMP DRIVE (WITHOUT AIR COMPRESSOR)	84005860	1	1002636	4014486480405
7	INTERMEDIATE SHAFT - ENGINE	89838606	1	1000654	4014486470178
8	BEATER SHAFT - MAIN DRIVE	89817374	1	1001876	4014486489231
11	AUGER (GRAIN)	80422731	1	1000696	4014486470772
12	BEATER SHAFT - ECCENTRIC SHAFT	80387469	1	1000700	4014486470833
13	STRAW ELEVATOR - BEATER SHAFT	80066232	1	1000690	4014486470697
13	STRAW ELEVATOR - BEATER SHAFT	80424563	1	1001765	4014486487480
14	HEADER DRIVE (CODE 1000) FOR L. CONV. TC56	89839375	1	1000774	4014486471830
14	HEADER DRIVE (CODE 0209) TC56	89817488	1	1001780	4014486487671
14	HEADER DRIVE (CODE 1000) FOR L. CONV. TC56	89835120	1	1001781	4014486487688
15	DRUM - BEATER SHAFT	80336784	1	1001506	4014486460216
18	STRAW WALKER - ECCENTRIC SHAFT	80431784	1	1000328	4014486465587
20	ROTARY SEPARATOR (CODE 2300)	89837412	1	1000573	4014486468816

NEW HOLLAND TC 57



No.	Application	OEM - PN	Set	Optibelt AP-Nr.	EAN
1		89838606	1	1000654	4014486470178
4	STRAW ELEVATOR - BEATER SHAFT	80424563	1	1001765	4014486487480
5		80825013	1	1001562	4014486484632
7		80330715	1	1000726	4014486471182
9		80755808	1	1001488	4014486459975
17		80387460	1	1001537	4014486460568
18	STRAW WALKER - ECCENTRIC SHAFT	80431784	1	1000328	4014486465587

BISO - Schrattecker
 BIZON
 CASE INTL. HARVESTER
 CLAAS
 DEUTZ-FAHR
 DRONNING-BORG
 FENDT
 FORTSCHRITT
 JOHN DEERE
 KRONE
 LAVERDA
 MASSEY FERGUSON
 NEW HOLLAND
 ROSTSELMASH

NEW HOLLAND TF 42

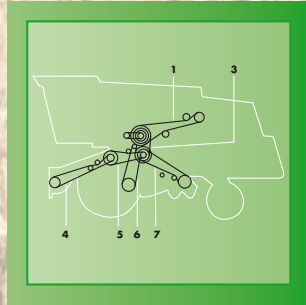
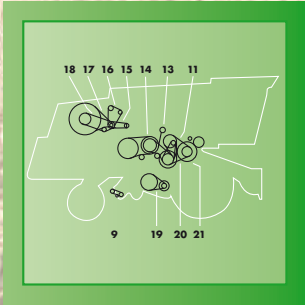

No.	Application	OEM - PN	Set	Optibelt AP-Nr.	EAN
3	BEATER TO INTERMEDIATE SHAFT (MERCEDES ENGINE)	80455865	1	1001954	4014486490596
4	STRAW ELEVATOR DRIVE	80433746	2	1000405	4014486466683
5	BEATER TO STRAW ELEVATOR	80434222	1	1001635	4014486485837
5	BEATER TO STRAW ELEVATOR	80743877	1	1003349	4014486490985
5	BEATER TO STRAW ELEVATOR	80350236	1	1003640	4014486489002
6	GROUND SPEED VARIATOR DRIVE	80440780	1	1001528	4014486460476
7	SHAKER SHOE DRIVE	80448794	1	1000756	4014486471571
11	BEATER (REAR) TO DRUM SHAFT	80186347	1	1003809	4014486518740
13	INTERMEDIATE SHAFT - ROTARY SEPARATOR	80434047	1	1001602	4014486485240
14	ROTARY SEPARATOR TO ROTOR	80434046	1	1000657	4014486470215
16	MERCEDES ENGINE	80432642	1	1003746	4014486495928
17	DUST CAP	80439495	1	1000173	4014486462005
18	FAN DRIVE	80439496	1	1002609	4014486496161
19	FAN DRIVE	80439832	1	1001415	4014486459227
21	INTERMEDIATE SHAFT - GRAIN ELEVATOR	80433639	1	1000237	4014486463408

NEW HOLLAND TF 44

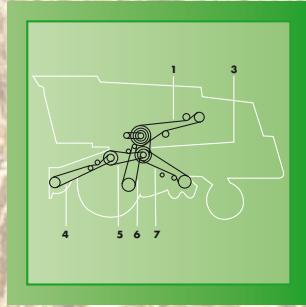
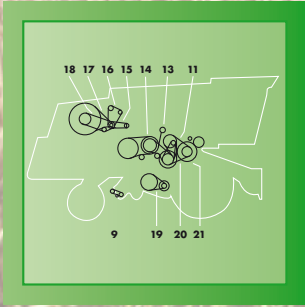

No.	Application	OEM - PN	Set	Optibelt AP-Nr.	EAN
3	BEATER TO INTERMEDIATE SHAFT (MERCEDES ENGINE)	80455865	1	1001954	4014486490596
4	STRAW ELEVATOR DRIVE	80433746	2	1000405	4014486466683
5	BEATER TO STRAW ELEVATOR	80434222	1	1001635	4014486485837
5	BEATER TO STRAW ELEVATOR	80743877	1	1003349	4014486490985
5	BEATER TO STRAW ELEVATOR	80350236	1	1003640	4014486489002
6	GROUND SPEED VARIATOR DRIVE	80440780	1	1001528	4014486460476
7	SHAKER SHOE DRIVE	80448794	1	1000756	4014486471571
11	BEATER (REAR) TO DRUM SHAFT	80186347	1	1003809	4014486518740
13	INTERMEDIATE SHAFT - ROTARY SEPARATOR	80434047	1	1001602	4014486485240
14	ROTARY SEPARATOR TO ROTOR	80434046	1	1000657	4014486470215
16	MERCEDES ENGINE	80432642	1	1003746	4014486495928
17	DUST CAP	80439495	1	1000173	4014486462005
18	FAN DRIVE	80439496	1	1002609	4014486496161
19	FAN DRIVE	80439832	1	1001415	4014486459227
21	INTERMEDIATE SHAFT - GRAIN ELEVATOR	80433639	1	1000237	4014486463408

NEW HOLLAND TF 46

No.	Application	OEM - PN	Set	Optibelt AP-Nr.	EAN
1	BEATER TO INTERMEDIATE DRIVE	80750166	1	1001242	4014486491975
2	MAIN DRIVE 4HB	80750290	1	1002008	4014486491371
3	DRUM DRIVE	84817628	1	1003345	4014486469844
4	STRAW ELEVATOR DRIVE - WITH LATERAL FLOTATION, 7401001 - 7406999	80453268	2	1000319	4014486465389
5	GRAIN TANK DISCHARGE DRIVE	84817636	1	1003404	4014486463255
5	GRAIN ELEVATOR DRUM DRIVE 3HB	84817632	1	1003639	4014486488999
6	CLEANING SHOE DRIVE	448794	1	1000756	4014486471571
6	INTERMEDIATE SHAFT DRIVE	89832601	1	1001288	4014486497861
7	ROTARY SEPARATOR	84448591	1	1000657	4014486470215
8	ROTOR TO UNDERSHOT BEATER	80427456	1	1003351	4014486464603
9	FAN DRIVE	80750318	1	1001134	4014486497182
9	ROTARY DUST SCREEN DRIVE, 7404001 - 7409999	87374615	1	1004049	4014486518436
10	COOLING FAN DRIVE - INTERMEDIATE SHAFT	80439496	1	1002609	4014486496161
11	WATERPUMP AND ALTERNATOR DRIVE, 7401001 - 7415999	80748003	2	1002974	4014486495935
11	WATERPUMP AND ALTERNATOR DRIVE, 7416001 - 7418999	452023	2	1002976	4014486495997
12	DUST - SCREEN BELT	80436304	1	1002482	4014486493788
14	MAIN DRIVE 2HB	84000191	1	1003616	4014486486667
16	CHOPPER DRIVE, 7422001 -	84000189	1	1000666	4014486470338
17	CHOPPER DRIVE, 7410001 -	80457309	1	1000181	4014486462104
18	WATERPUMP DRIVE	80443634	1	1002543	4014486494723

NEW HOLLAND TF 76



No.	Application	OEM - PN	Set	Optibelt AP-Nr.	EAN
1	MAIN DRIVE BELT	84817623	1	1001954	4014486490596
2	HYDROSTATIC DRIVE	84817631	1	1002006	4014486491340
3	FAN DRIVE	84817629	1	1001557	4014486484564
4	DRIVE BESIDES STRAW ELEVATOR 4HB	9593400	1	1002029	4014486491647
5	BEATER TO STRAW ELEVATOR 2HB	80434222	1	1001635	4014486485837
5	BEATER TO STRAW ELEVATOR 2HB	84817632	1	1003639	4014486488999
6	SHAKER SHOE DRIVE	448794	1	1000756	4014486471571
10	CHOPPER, DRIVE FOR TF76 ONLY	84000189	1	1000666	4014486470338
12	DRUM DRIVE	84817628	1	1003345	4014486469844
14	AUGER DRIVE	84817636	1	1003404	4014486463255
15	BEATER TO INTERMEDIATE DRIVE	89832601	1	1001288	4014486497861
16	ROTARY SEPARATOR	84448591	1	1000657	4014486470215
17	THROW-OUT BEATER DRIVE	80427456	1	1003351	4014486464603
18	CLEANING FAN DRIVE	84817627	1	1001135	4014486497199
21	CHOPPER, DRIVE FOR TF76 ONLY	84000189	1	1000666	4014486470338
22	CENTRIFUGAL SEPARATOR	84817639	1	1002608	4014486496154
23	ALTERNATOR, WATERPUMP AND FAN	84817638	1	1003807	4014486483048
24	HYDRAULIC PUMP	84817670	2	1002969	4014486495584
25	CLEANING FAN DRIVE	84817630	1	1002606	4014486496130
26	COMPRESSOR DRIVE	84817626	1	1002579	4014486495560

NEW HOLLAND TF 78, TR 70

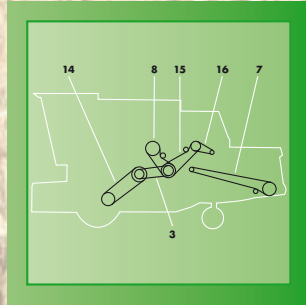
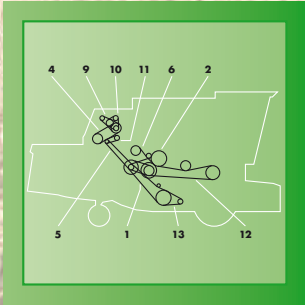

No.	Application	OEM - PN	Set	Optibelt AP-Nr.	EAN
1	THRESHING, DRIVE, BELT AND GUARD	80750166	1	1001242	4014486491975
2	HYDROSTATIC DRIVE	84817631	1	1002006	4014486491340
3	FAN DRIVE 2 HB	84817629	1	1001557	4014486484564
4	DRIVE BESIDES STRAW ELEVATOR 4HB	9593400	1	1002029	4014486491647
5	BEATER TO STRAW ELEVATOR 2HB	80434222	1	1001635	4014486485837
5	BEATER TO STRAW ELEVATOR 2HB	84817632	1	1003639	4014486488999
6	SHAKER SHOE DRIVE	448794	1	1000756	4014486471571
10	CHOPPER, DRIVE FOR TF78 ONLY	84000189	1	1000666	4014486470338
12	DRUM DRIVE	84817628	1	1003345	4014486469844
14	AUGER DRIVE	84817636	1	1003404	4014486463255
15	BEATER TO INTERMEDIATE DRIVE	89832601	1	1001288	4014486497861
16	ROTARY SEPARATOR	84448591	1	1000657	4014486470215
17	THROW-OUT BEATER DRIVE	80427456	1	1003351	4014486464603
18	CLEANING FAN DRIVE	84817627	1	1001135	4014486497199
22	ROTARY SCREEN DRIVE	84021588	1	1000083	4014486519358
23	AIR CONDITIONER, ENGINE PARTS	84007307	2	1002605	4014486496123
25	ROTARY SCREEN DRIVE	84021590	1	1000082	4014486519341
6	ROTOR DRIVE (OPT FOR HIGH SPEED)	715785	1	1004170	4014486522808
10	ALTERNATOR AND FAN DRIVE (CATERPILLAR ENGINE DIESEL)	626654	2	1002963	4014486495324

NEW HOLLAND TR 75, TR 85

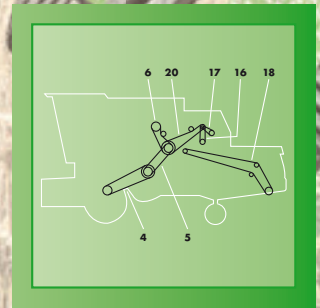
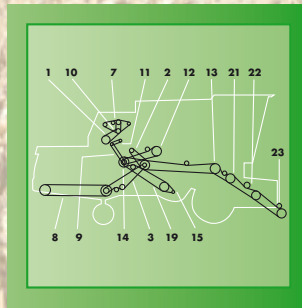
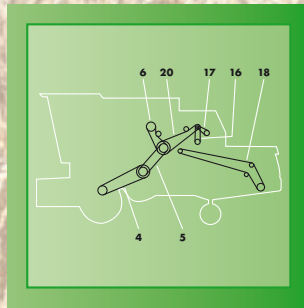
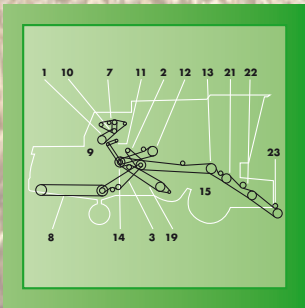

No.	Application	OEM - PN	Set	Optibelt AP-Nr.	EAN
13	HEADER DRIVE 193	682008	1	1004122	4014486522969
22	FEEDER HOUSE FIXED SPEED	621367	1	1004120	4014486522945
13	HEADER DRIVE 193	682008	1	1004122	4014486522969
22	FEEDER HOUSE FIXED SPEED	621367	1	1004120	4014486522945

NEW HOLLAND TR 86, TR 95

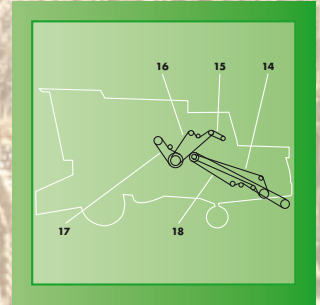
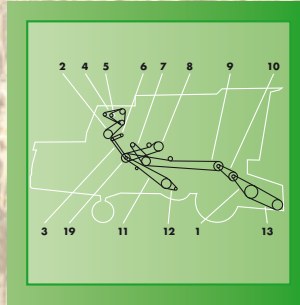
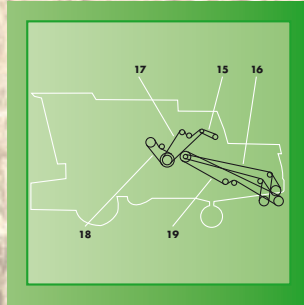
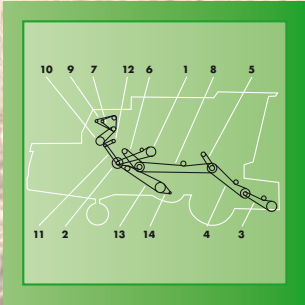

No.	Application	OEM - PN	Set	Optibelt AP-Nr.	EAN
4	FEEDER HOUSE FIXED SPEED	621367	1	1004120	4014486522945
4	SMALL GRAIN SPECIAL	9613963	1	1004140	4014486523201
4	FEEDER DRIVE VARIABLE SPEED	849514	1	1004169	4014486522792
7	ENGINE FAN HYDRAULIC PUMP	855676	1	1003746	4014486495928
8	HEADER DRIVE	682008	1	1004122	4014486522969
9	ALTERNATOR DRIVE	626654	2	1002963	4014486495324
10	HYDRAULIC PUMP DRIVE	855676	1	1003746	4014486495928
15	AIR CONDITIONING COMPRESSOR DRIVE	577240	1	1002565	4014486495225
1	FEEDER HOUSE FIXED SPEED	621367	1	1004120	4014486522945
2	HYDRAULIC PUMP DRIVE	624650	2	1002841	4014486464078
3	ROTARY SCREEN DRIVE	615790	1	1004108	4014486522839
4	ALTERNATOR AND WATERPUMP DRIVE	626654	2	1002963	4014486495324
6	ALTERNATOR DRIVE	626657	1	1002568	4014486495317
11	SHAKER SHOE DRIVE	774747	1	1001633	4014486485783
12	CLEANING FAN - VARIATOR DRIVE (WITHOUT SLOW DOWN)	710752	1	1004167	4014486522778
12	CLEANING FAN - VARIATOR DRIVE (WITHOUT INT.SPEED KIT)	773300	1	1004168	4014486522785
16	HYDROSTATIC PUMP DRIVE AND MAIN SHAFT	649035	1	1004151	4014486523324
18	STRAW SPREADER DRIVE	618040	1	1004117	4014486522914

NEW HOLLAND TR 96

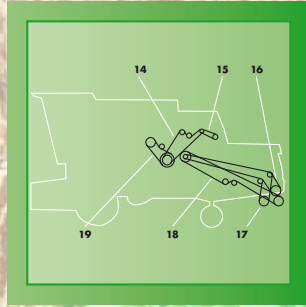
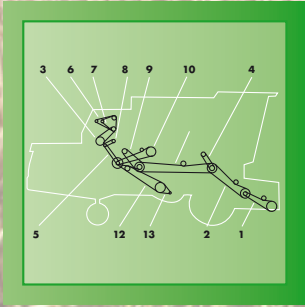

No.	Application	OEM - PN	Set	Optibelt AP-Nr.	EAN
2	FEEDER HOUSE FIXED SPEED	621367	1	1004120	4014486522945
2	SMALL GRAIN SPECIAL - 3HB	9613963	1	1004140	4014486523201
2	FEEDER DRIVE VARIABLE SPEED	849514	1	1004169	4014486522792
3	HYDRAULIC PUMP DRIVE	624650	2	1002841	4014486464078
3	ENGINE FAN AND HYDRAULIC PUMP	855676	1	1003746	4014486495928
3	ENGINE FAN DRIVE	768340	2	1004158	4014486554397
5	ROTARY SCREEN DRIVE (PRIMARY)	615790	1	1004108	4014486522839
5	ROTARY SCREEN DRIVE (PRIMARY)	859063	1	1004164	4014486522983
6	ALTERNATOR DRIVE	626657	1	1002568	4014486495317
6	ALTERNATOR DRIVE	626654	2	1002963	4014486495324
10	CLEAN GRAIN ELEVATOR DRIVE IMPROVED	9604713	1	1004126	4014486523089
11	HEADER DRIVE	682008	1	1004122	4014486522969
12	SHAKER SHOE DRIVE	774747	1	1001633	4014486485783
13	CLEANING FAN - VARIATOR DRIVE 61.6 INT SPEED	773300	1	1004168	4014486522785
14	HYDROSTATIC - MAIN SHAFT DRIVE	649035	1	1004151	4014486523324
14	HYDROSTATIC - MAIN SHAFT DRIVE	797979	1	1004152	4014486523331
15	AIR CONDITIONING COMPRESSOR DRIVE	626657	1	1002568	4014486495317
16	STRAW SPREADER DRIVE	618040	1	1004117	4014486522914

NEW HOLLAND TR 97, TR 98



No.	Application	OEM - PN	Set	Optibelt AP-Nr.	EAN
1	ENGINE FAN HYDRAULIC PUMP	855676	1	1003746	4014486495928
6	CLEAN GRAIN ELEVATOR DRIVE IMPROVED	9604713	1	1004126	4014486523089
7	HEADER DRIVE	682008	1	1004122	4014486522969
8	HYDRAULIC REEL PUMP DRIVE	9609607	1	1000230	4014486463187
9	ROTARY SCREEN DRIVE (PRIMARY)	859063	1	1004164	4014486522983
10	SHAKER SHOE DRIVE	774747	1	1001633	4014486485783
13	FEEDER HOUSE FIXED SPEED	621367	1	1004120	4014486522945
15	HYDROSTATIC - MAIN SHAFT DRIVE	797979	1	1004152	4014486523331
16	AIR CONDITIONING COMPRESSOR DRIVE	626657	1	1002568	4014486495317
17	STRAW SPREADER DRIVE	618040	1	1004117	4014486522914
1	HYDRAULIC PUMP DRIVE	773255	1	1002582	4014486495638
6	CLEAN GRAIN ELEVATOR DRIVE IMPROVED	9604713	1	1004126	4014486523089
7	HEADER DRIVE	86503087	1	1004123	4014486522976
8	HYDRAULIC REEL PUMP DRIVE	9609607	1	1000230	4014486463187
9	ROTARY SCREEN DRIVE (PRIMARY)	859063	1	1004164	4014486522983
10	SHAKER SHOE DRIVE	774747	1	1001633	4014486485783
13	FEEDER HOUSE FIXED SPEED	9613963	1	1004140	4014486523201
16	AIR CONDITIONING COMPRESSOR DRIVE	577240	1	1002565	4014486495225
17	STRAW SPREADER DRIVE	618040	1	1004117	4014486522914
20	UNLOADING AUGER DRIVE	86514256	1	1004119	4014486522938

NEW HOLLAND TX 30

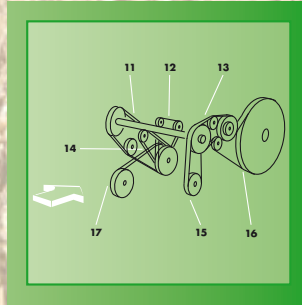
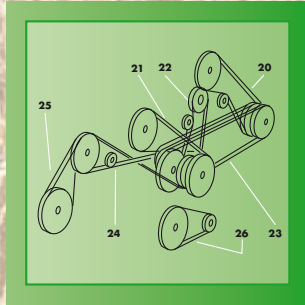
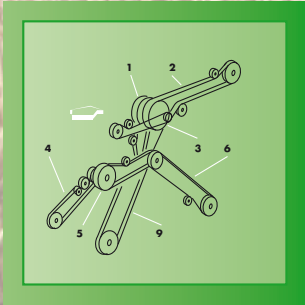

No.	Application	OEM - PN	Set	Optibelt AP-Nr.	EAN
1	BEATER TO INTERMEDIATE DRIVE	80455865	1	1001954	4014486490596
2	ENGINE TO BEATER SHAFT - MECHANICAL DRIVE	80922911	1	1002004	4014486491319
2	HYDROSTATIC DRIVE - ENGINE TO BEATER SHAFT	80922872	1	1003667	4014486491302
3	UNLOADING AUGER ENGAGING	89512971	1	1003801	4014486518634
4	STRAW ELEVATOR DRIVE	80433746	2	1000405	4014486466683
5	BEATER TO STRAW ELEVATOR	80350236	1	1003640	4014486489002
6	CLEANING SHOE DRIVE	80448794	1	1000756	4014486471571
9	GROUND SPEED VARIATOR DRIVE	80440780	1	1001528	4014486460476
11	COOLING FAN DRIVE - INTERMEDIATE SHAFT	80913151	1	1003429	4014486464221
12	WATERPUMP DRIVE	80443634	1	1002543	4014486494723
13	ROTARY DUST SCREEN DRIVE	80913153	1	1000081	4014486484021
16	DUST SCREEN DRIVE	80923019	1	1000166	4014486461916
20	BEATER DRIVE	89513984	1	1000631	4014486469837
21	ROTARY SEPARATOR DRIVE	80754285	1	1000594	4014486469233
22	STORAGE DRIVE GRAIN	80433639	1	1000237	4014486463408
24	STRAW WALKER - INTERMEDIATE SHAFT DRIVE	80754389	1	1003339	4014486465426
25	STRAW WALKER DRIVE	80754388	1	1003341	4014486462999
26	CLEANING FAN - VARIATOR DRIVE	89502654	1	1001135	4014486497199

NEW HOLLAND TX 32

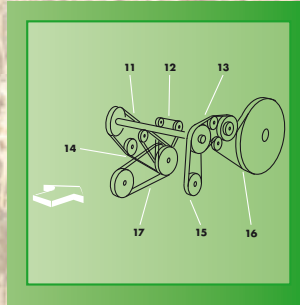
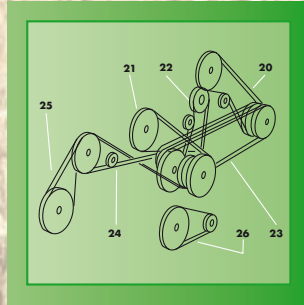
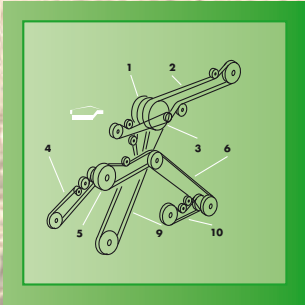

No.	Application	OEM - PN	Set	Optibelt AP-Nr.	EAN
1	BEATER TO INTERMEDIATE DRIVE	80455865	1	1001954	4014486490596
2	ENGINE TO BEATER SHAFT - MECHANICAL DRIVE	80922911	1	1002004	4014486491319
2	HYDROSTATIC DRIVE - ENGINE TO BEATER SHAFT	80922872	1	1003667	4014486491302
3	UNLOADING AUGER ENGAGING	89512971	1	1003801	4014486518634
4	STRAW ELEVATOR SIDE	80433746	2	1000405	4014486466683
5	BEATER TO STRAW ELEVATOR	80434222	1	1001635	4014486485837
5	BEATER TO STRAW ELEVATOR	80350236	1	1003640	4014486489002
6	CLEANING SHOE DRIVE - FIXED SHOE	80446780	1	1000750	4014486471472
6	CLEANING SHOE DRIVE - SELF-LEVELLING	80448794	1	1000756	4014486471571
9	GROUND SPEED VARIATOR DRIVE	80440780	1	1001528	4014486460476
10	ECCENTRIC SHAFT DRIVE / FIXED SHOE ONLY	80230164	1	1000622	4014486469660
11	COOLING FAN DRIVE - INTERMEDIATE SHAFT	80913151	1	1003429	4014486464221
12	WATERPUMP DRIVE	80443634	1	1002543	4014486494723
13	ROTARY DUST SCREEN DRIVE	80913153	1	1000081	4014486484021
16	DUST SCREEN DRIVE	80923019	1	1000166	4014486461916
20	BEATER DRIVE - CODE 123	89513984	1	1000631	4014486469837
20	BEATER DRIVE - CODE 124	80186347	1	1003809	4014486518740
21	ROTARY SEPARATOR DRIVE	80754285	1	1000594	4014486469233
22	STORAGE DRIVE GRAIN	80433639	1	1000237	4014486463408
24	STRAW WALKER - INTERMEDIATE SHAFT DRIVE	80754389	1	1003339	4014486465426
25	STRAW WALKER DRIVE	80754388	1	1003341	4014486462999
26	CLEANING FAN - CODE 111 / SELF-LEVELLING	89502654	1	1001135	4014486497199

NEW HOLLAND TX 32

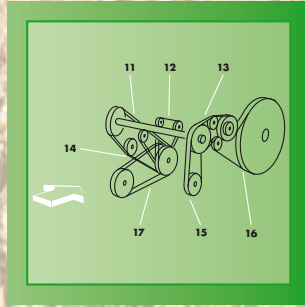
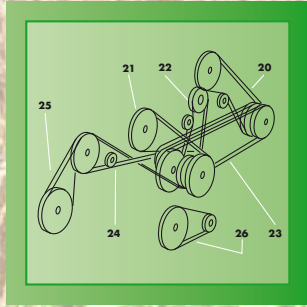
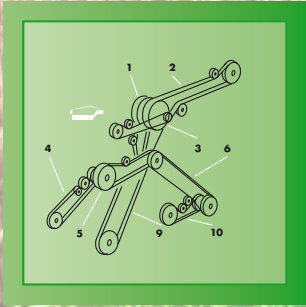

26	CLEANING FAN - CODE 111 / FIXED SHOE	80919739	1	1001136	4014486497205
26	CLEANING FAN - CODE 110 / SELF-LEVELLING	80439832	1	1001415	4014486459227

NEW HOLLAND TX 34

No.	Application	OEM - PN	Set	Optibelt AP-Nr.	EAN
2	ENGINE TO BEATER SHAFT - MECHANICAL DRIVE	80922911	1	1002004	4014486491319
2	HYDROSTATIC DRIVE - ENGINE TO BEATER SHAFT	80922872	1	1003667	4014486491302
3	STRAW ELEVATOR DRIVE	80433746	2	1000405	4014486466683
4	BEATER TO STRAW ELEVATOR	80434222	1	1001635	4014486485837
4	BEATER TO STRAW ELEVATOR	80743877	1	1003349	4014486490985
4	BEATER TO REINFORCED STRAW ELEVATOR	80350236	1	1003640	4014486489002
5	GROUND SPEED VARIATOR DRIVE	80440780	1	1001528	4014486460476
6	BEATER TO INTERMEDIATE DRIVE	80455865	1	1001954	4014486490596
7	CLEANING SHOE DRIVE	80448794	1	1000756	4014486471571
8		80923019	1	1000166	4014486461916
10		80913153	1	1000081	4014486484021
11	WATERPUMP DRIVE	80443634	1	1002543	4014486494723
13	ROTARY SEPARATOR DRIVE	80754285	1	1000594	4014486469233
14		80434047	1	1001602	4014486485240
15		80754165	1	1002415	4014486494280
18	STRAW WALKER DRIVE	80754388	1	1003341	4014486462999
19	STRAW WALKER - INTERMEDIATE SHAFT DRIVE	80754389	1	1003339	4014486465426
20	CLEANING FAN - VARIATOR DRIVE	80439832	1	1001415	4014486459227
21	STORAGE DRIVE GRAIN	80433639	1	1000237	4014486463408

NEW HOLLAND TX 36

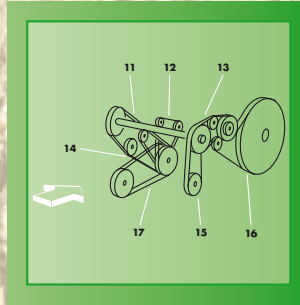
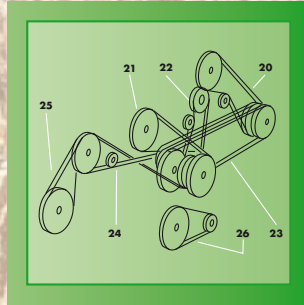
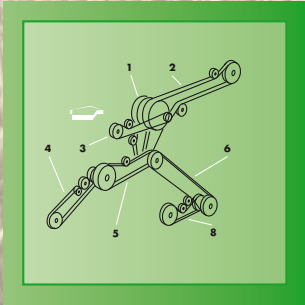

No.	Application	OEM - PN	Set	Optibelt AP-Nr.	EAN
1	BEATER TO INTERMEDIATE DRIVE	80455865	1	1001954	4014486490596
2	ENGINE TO BEATER SHAFT	80922872	1	1003667	4014486491302
3	UNLOADING AUGER ENGAGING - CODE 129	89512971	1	1003801	4014486518634
5	BEATER TO STRAW ELEVATOR	80434222	1	1001635	4014486485837
5	BEATER TO STRAW ELEVATOR	80350236	1	1003640	4014486489002
6	ECCENTRIC SHAFT - CODE 108 / BLOCKED FRAME	80230164	1	1000622	4014486469660
6	CLEANING SHOE DRIVE	80448794	1	1000756	4014486471571
11	COOLING FAN DRIVE - INTERMEDIATE SHAFT	80913151	1	1003429	4014486464221
12	WATERPUMP DRIVE	80443634	1	1002543	4014486494723
13	ROTARY DUST SCREEN DRIVE	80913153	1	1000081	4014486484021
16	DUST SCREEN DRIVE	80923019	1	1000166	4014486461916
20	BEATER DRIVE - CODE 117	89513984	1	1000631	4014486469837
20	BEATER DRIVE - CODE 118	80186347	1	1003809	4014486518740
21	ROTARY SEPARATOR DRIVE	80754285	1	1000594	4014486469233
22	STORAGE DRIVE GRAIN	80433639	1	1000237	4014486463408
24	STRAW WALKER - INTERMEDIATE SHAFT DRIVE	80754389	1	1003339	4014486465426
25	STRAW WALKER DRIVE	80754388	1	1003341	4014486462999
26	CLEANING FAN - VARIATOR DRIVE	89502654	1	1001135	4014486497199

NEW HOLLAND TX 62

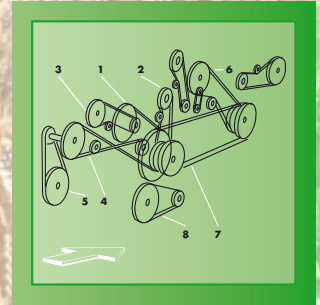
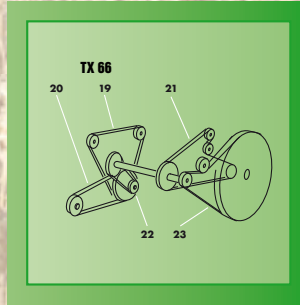
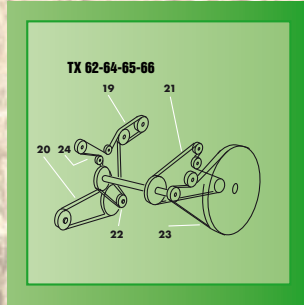
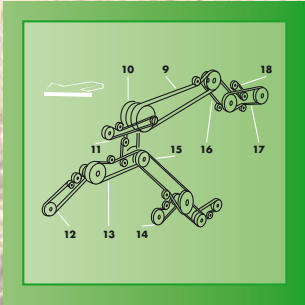

No.	Application	OEM - PN	Set	Optibelt AP-Nr.	EAN
1	ROTIERENDER ABSCHIEDERANTRIEB UND WELLE	84015531	1	1000601	4014486469332
2		84015852	1	1000231	4014486520491
3		84015852	1	1000231	4014486520491
4		80754389	1	1003339	4014486465426
5		80754388	1	1003341	4014486462999
6		89513984	1	1000631	4014486469837
7		89832601	1	1001288	4014486497861
8	GRASS SEED SELF LEVELLING	84023277	1	1001132	4014486497168
8	GRASS SEED FIXED SHOE BLOCKED FRAME	84023278	1	1001133	4014486497175
8	SELF LEVELLING	89502654	1	1001135	4014486497199
9		80922911	1	1002004	4014486491319
10		80455865	1	1001954	4014486490596
11		89814069	1	1001557	4014486484564
12		89593440	1	1000816	4014486472417
12		89593464	1	1004077	4014486520415
13		80434222	1	1001635	4014486485837
14	FIXED SHOE	80230164	1	1000622	4014486469660
15	BLOCKED FRAME	80446780	1	1000750	4014486471472
15	FIXED SHOE	80448794	1	1000756	4014486471571
16	SELF LEVELLING	84005417	1	1001655	4014486486094
16		84004444	1	1001657	4014486486117
17	STRAW CHOPPER DRIVE	84017621	1	1001702	4014486486797

NEW HOLLAND TX 62, TX 63

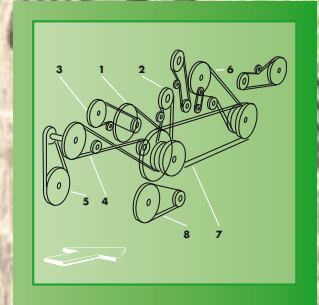
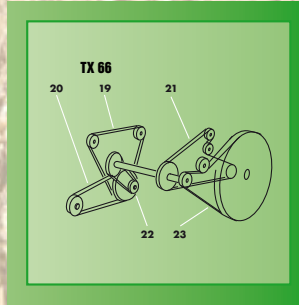
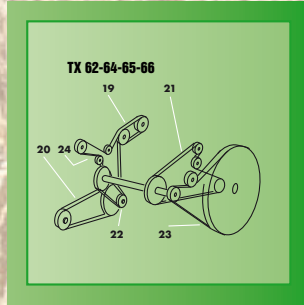
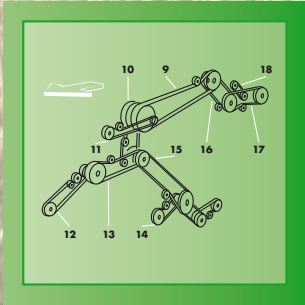

19		80754165	1	1002415	4014486494280
19		84007307	2	1002605	4014486496123
22		84000838	2	1002603	4014486496109
22		84007307	2	1002605	4014486496123
1		84015531	1	1000601	4014486469332
2		84015852	1	1000231	4014486520491
3		84015852	1	1000231	4014486520491
4		80754389	1	1003339	4014486465426
5		80754388	1	1003341	4014486462999
6		89513984	1	1000631	4014486469837
7		89832601	1	1001288	4014486497861
8	GRASS SEED SELF LEVELLING	84023277	1	1001132	4014486497168
8	GRASS SEED FIXED SHOE BLOCKED FRAME	84023278	1	1001133	4014486497175
8	SELF LEVELLING	89502654	1	1001135	4014486497199
9		80922911	1	1002004	4014486491319
10		80455865	1	1001954	4014486490596
11		89814069	1	1001557	4014486484564
12		89593440	1	1000816	4014486472417
12		89593464	1	1004077	4014486520415
13		80434222	1	1001635	4014486485837
14	FIXED SHOE	80230164	1	1000622	4014486469660

NEW HOLLAND TX 63, TX 64

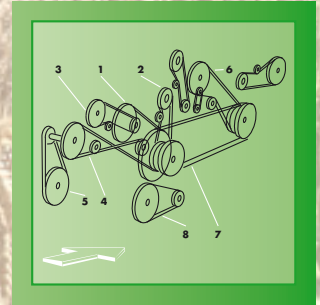
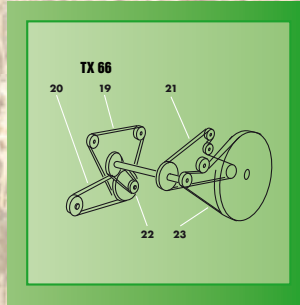
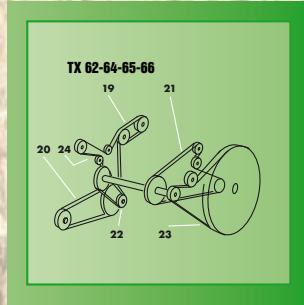
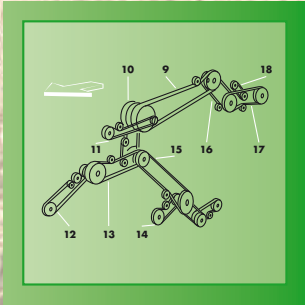

No.	Application	OEM - PN	Set	Optibelt AP-Nr.	EAN
15	BLOCKED FRAME	80446780	1	1000750	4014486471472
15	FIXED SHOE	80448794	1	1000756	4014486471571
16	SELF LEVELLING	84005417	1	1001655	4014486486094
16		84004444	1	1001657	4014486486117
17	STRAW CHOPPER DRIVE	84017621	1	1001702	4014486486797
19		80754165	1	1002415	4014486494280
19		84007307	2	1002605	4014486496123
22		84000838	2	1002603	4014486496109
22		84007307	2	1002605	4014486496123
1		84015531	1	1000601	4014486469332
2		84015852	1	1000231	4014486520491
3		84015852	1	1000231	4014486520491
4		80754389	1	1003339	4014486465426
5		80754388	1	1003341	4014486462999
6		89513984	1	1000631	4014486469837
7		89832601	1	1001288	4014486497861
8	GRASS SEED SELF LEVELLING	84023277	1	1001132	4014486497168
8	GRASS SEED FIXED SHOE BLOCKED FRAME	84023278	1	1001133	4014486497175
8	SELF LEVELLING	89502654	1	1001135	4014486497199
9		80922911	1	1002004	4014486491319
10		80455865	1	1001954	4014486490596

NEW HOLLAND TX 64, TX 65

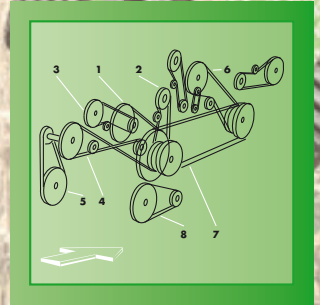
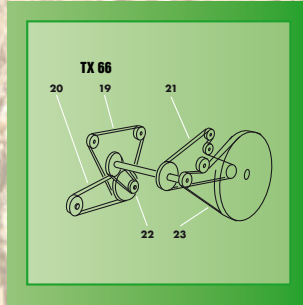
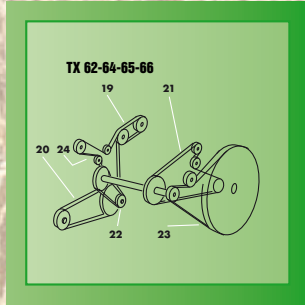
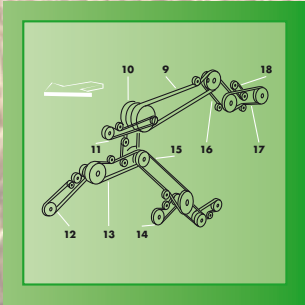

11		89814069	1	1001557	4014486484564
12		89593440	1	1000816	4014486472417
12		89593464	1	1004077	4014486520415
13		80434222	1	1001635	4014486485837
14	FIXED SHOE	80230164	1	1000622	4014486469660
15	BLOCKED FRAME	80446780	1	1000750	4014486471472
15	FIXED SHOE	80448794	1	1000756	4014486471571
16	SELF LEVELLING	84005417	1	1001655	4014486486094
16		84004444	1	1001657	4014486486117
17	STRAW CHOPPER DRIVE	84017621	1	1001702	4014486486797
19		80754165	1	1002415	4014486494280
19		84007307	2	1002605	4014486496123
22		84000838	2	1002603	4014486496109
22		84007307	2	1002605	4014486496123
1		84015531	1	1000601	4014486469332
2		84015852	1	1000231	4014486520491
3		84015852	1	1000231	4014486520491
4		80754389	1	1003339	4014486465426
5		80754388	1	1003341	4014486462999
6		89513984	1	1000631	4014486469837
7		89832601	1	1001288	4014486497861

NEW HOLLAND TX 65, TX 66

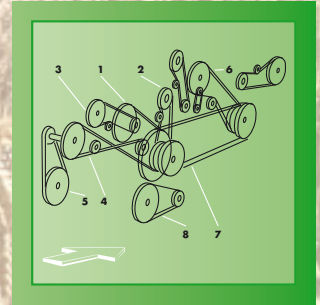
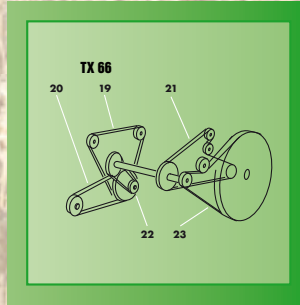
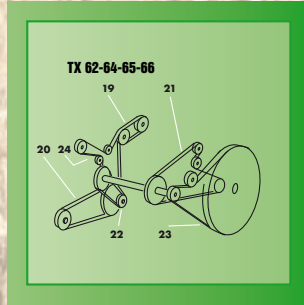
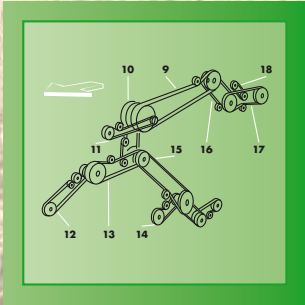

No.	Application	OEM - PN	Set	Optibelt AP-Nr.	EAN
8	GRASS SEED SELF LEVELLING	84023277	1	1001132	4014486497168
8	GRASS SEED FIXED SHOE BLOCKED FRAME	84023278	1	1001133	4014486497175
8	SELF LEVELLING	89502654	1	1001135	4014486497199
9		80922911	1	1002004	4014486491319
10		80455865	1	1001954	4014486490596
11		89814069	1	1001557	4014486484564
12		89593440	1	1000816	4014486472417
12		89593464	1	1004077	4014486520415
13		80434222	1	1001635	4014486485837
14	FIXED SHOE	80230164	1	1000622	4014486469660
15	BLOCKED FRAME	80446780	1	1000750	4014486471472
15	FIXED SHOE	80448794	1	1000756	4014486471571
16	SELF LEVELLING	84005417	1	1001655	4014486486094
16		84004444	1	1001657	4014486486117
17	STRAW CHOPPER DRIVE	84017621	1	1001702	4014486486797
19		80754165	1	1002415	4014486494280
19		84007307	2	1002605	4014486496123
22		84000838	2	1002603	4014486496109
22		84007307	2	1002605	4014486496123
1		84015531	1	1000601	4014486469332
2		84015852	1	1000231	4014486520491

NEW HOLLAND TX 66

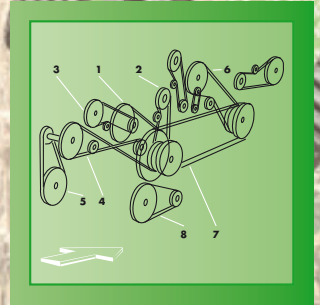
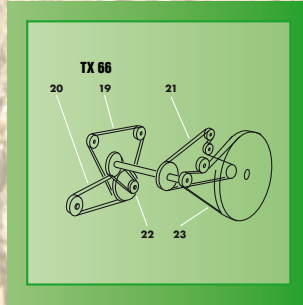
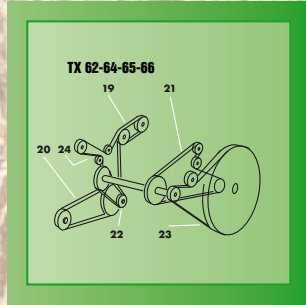
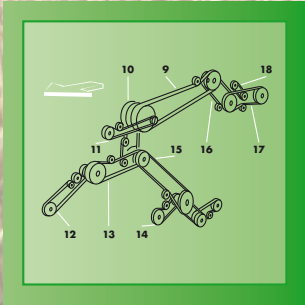

3		84015852	1	1000231	4014486520491
4		80754389	1	1003339	4014486465426
5		80754388	1	1003341	4014486462999
6		89513984	1	1000631	4014486469837
7		89832601	1	1001288	4014486497861
8	GRASS SEED SELF LEVELLING	84023277	1	1001132	4014486497168
8	GRASS SEED FIXED SHOE BLOCKED FRAME	84023278	1	1001133	4014486497175
8	SELF LEVELLING	89502654	1	1001135	4014486497199
9		80922911	1	1002004	4014486491319
10		80455865	1	1001954	4014486490596
11		89814069	1	1001557	4014486484564
12		89593440	1	1000816	4014486472417
12		89593464	1	1004077	4014486520415
13		80434222	1	1001635	4014486485837
14	FIXED SHOE	80230164	1	1000622	4014486469660
15	BLOCKED FRAME	80446780	1	1000750	4014486471472
15	FIXED SHOE	80448794	1	1000756	4014486471571
16	SELF LEVELLING	84005417	1	1001655	4014486486094
16		84004444	1	1001657	4014486486117
17	STRAW CHOPPER DRIVE	84017621	1	1001702	4014486486797
19		80754165	1	1002415	4014486494280
19		84007307	2	1002605	4014486496123

NEW HOLLAND TX 66, TX 67

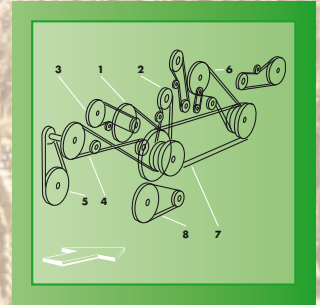
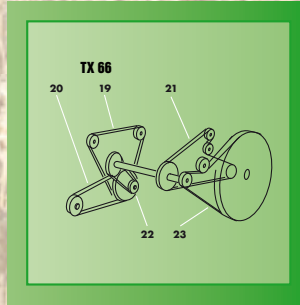
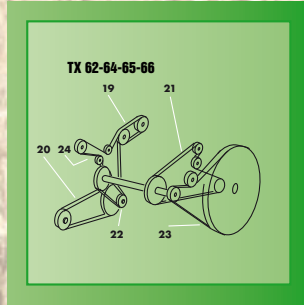
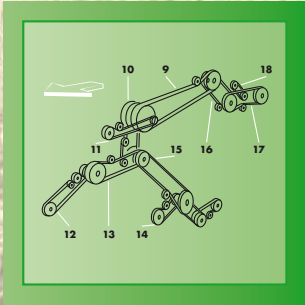

No.	Application	OEM - PN	Set	Optibelt AP-Nr.	EAN
22		84000838	2	1002603	4014486496109
22		84007307	2	1002605	4014486496123
1		84015531	1	1000601	4014486469332
2		84015852	1	1000231	4014486520491
3		84015852	1	1000231	4014486520491
4		80754389	1	1003339	4014486465426
5		80754388	1	1003341	4014486462999
6		89513984	1	1000631	4014486469837
7		89832601	1	1001288	4014486497861
8	GRASS SEED SELF LEVELLING	84023277	1	1001132	4014486497168
8	GRASS SEED FIXED SHOE BLOCKED FRAME	84023278	1	1001133	4014486497175
8	SELF LEVELLING	89502654	1	1001135	4014486497199
9		80922911	1	1002004	4014486491319
10		80455865	1	1001954	4014486490596
11		89814069	1	1001557	4014486484564
12		89593440	1	1000816	4014486472417
12		89593464	1	1004077	4014486520415
13		80434222	1	1001635	4014486485837
14	FIXED SHOE	80230164	1	1000622	4014486469660
15	BLOCKED FRAME	80446780	1	1000750	4014486471472
15	FIXED SHOE	80448794	1	1000756	4014486471571

NEW HOLLAND TX 67, TX 68

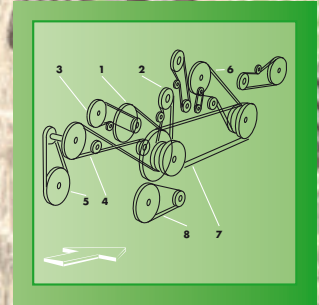
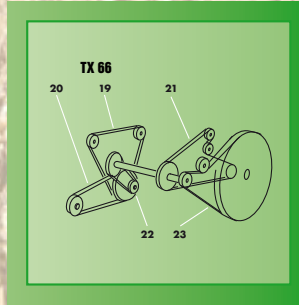
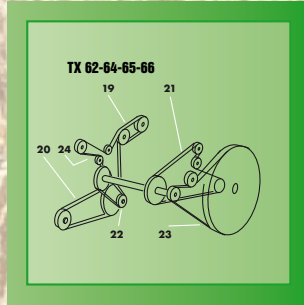
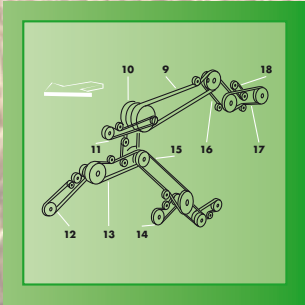

16	SELF LEVELLING	84005417	1	1001655	4014486486094
16		84004444	1	1001657	4014486486117
17	STRAW CHOPPER DRIVE	84017621	1	1001702	4014486486797
19		80754165	1	1002415	4014486494280
19		84007307	2	1002605	4014486496123
22		84000838	2	1002603	4014486496109
22		84007307	2	1002605	4014486496123
1		84015531	1	1000601	4014486469332
2		84015852	1	1000231	4014486520491
3		84015852	1	1000231	4014486520491
4		80754389	1	1003339	4014486465426
5		80754388	1	1003341	4014486462999
6		89513984	1	1000631	4014486469837
7		89832601	1	1001288	4014486497861
8	GRASS SEED SELF LEVELLING	84023277	1	1001132	4014486497168
8	GRASS SEED FIXED SHOE BLOCKED FRAME	84023278	1	1001133	4014486497175
8	SELF LEVELLING	89502654	1	1001135	4014486497199
9		80922911	1	1002004	4014486491319
10		80455865	1	1001954	4014486490596
11		89814069	1	1001557	4014486484564
12		89593440	1	1000816	4014486472417

NEW HOLLAND TX 68

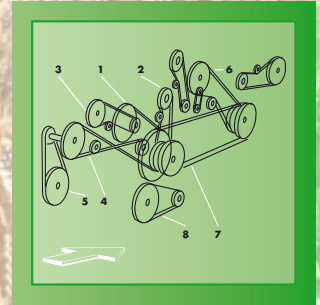
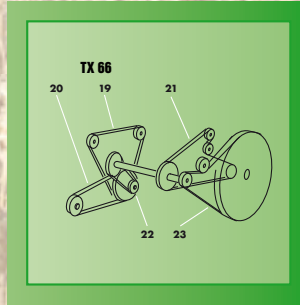
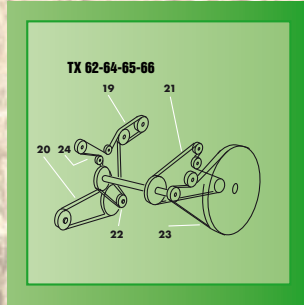
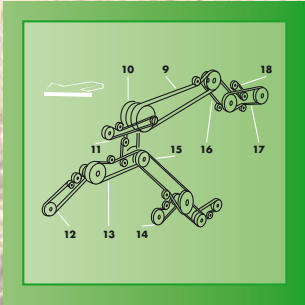

No.	Application	OEM - PN	Set	Optibelt AP-Nr.	EAN
12		89593464	1	1004077	4014486520415
13		80434222	1	1001635	4014486485837
14	FIXED SHOE	80230164	1	1000622	4014486469660
15	BLOCKED FRAME	80446780	1	1000750	4014486471472
15	FIXED SHOE	80448794	1	1000756	4014486471571
16	SELF LEVELLING	84005417	1	1001655	4014486486094
16		84004444	1	1001657	4014486486117
17	STRAW CHOPPER DRIVE	84017621	1	1001702	4014486486797
19		80754165	1	1002415	4014486494280
19		84007307	2	1002605	4014486496123
22		84000838	2	1002603	4014486496109
22		84007307	2	1002605	4014486496123

ROSTSELMASH ACROS 530

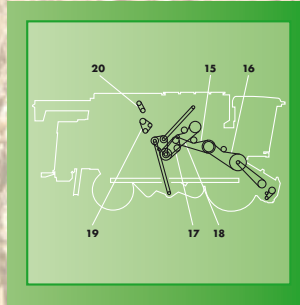
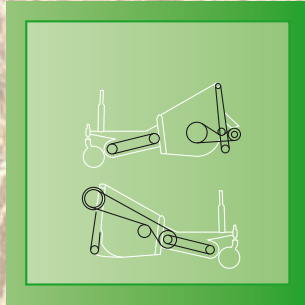
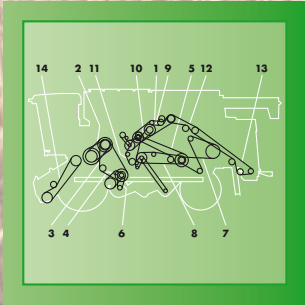

No.	Application	OEM - PN	Set	Optibelt AP-Nr.	EAN
1	MAIN COUNTERSHAFT DRIVE	6201249	1	1001306	4014486492644
2	DRUM DRIVE VARIABLE SPEED	6201246	1	1001291	4014486497885
3	CLEANING FAN - COUNTERSHAFT	6201297	2	1002229	4014486477917
4	CLEANING SHAFT DRIVE	6201269	2	1003313	4014486476323
5	COUNTER DRIVE (REAR)	6201378	1	1001673	4014486486377
6	CLEANING FAN DRIVE	6201273	1	1001003	4014486497267
7	SHAKER SHAFT DRIVE	6201326	4	1003317	4014486472226
8	ELEVATOR DRIVE UNIT	6201275	2	1003315	4014486477535
9	AUGER FOR UNLOADING	6201316	1	1001609	4014486485363
10	UNLOADING BOTTOM SPEED REDUCER	6201316	1	1001609	4014486485363
11	FINAL THRESHING UNIT	6201376	2	1002155	4014486476743
12	CUTTING DRUM COUNTERDRIVE	6201316	1	1001609	4014486485363
13	CUTTING DRUM	6201375	1	1001700	4014486486766
14	TRANSMISSION SHAFT	6201094	1	1002007	4014486491357
15	BEATER DRIVE	6201377	1	1001305	4014486492637
16	TILTED PLATFORM CHAMBER SHAFT	6201251	1	1003329	4014486491197
17	COUNTER DRIVE GRAIN	6201263	2	1002213	4014486477641
18	AUGER DRIVE	6201275	2	1003315	4014486477535
19	DUST REMOVING FAN	6201028	1	1000217	4014486462760
20	AIR CONDITIONING COMPRESSOR DRIVE	6201371	1	1002529	4014486494488
22	TILTED CHAMBER COUNTERDRIVE	6201094	1	1002007	4014486491357
23	CUTTING UNIT DRIVE	6201271	2	1002226	4014486477849

ROSTSELMASH DON 1500 A

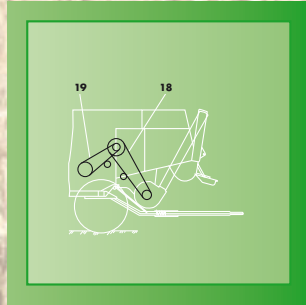
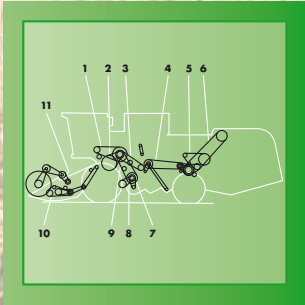

No.	Application	OEM - PN	Set	Optibelt AP-Nr.	EAN
1	THRESHING DRUM VARIATOR DRIVE	6201249	1	1001306	4014486492644
2	DRUM DRIVE VARIABLE SPEED	6201246	1	1001291	4014486497885
3	FINAL THRESHING UNIT	6201272	1	1002186	4014486477306
4	ELEVATOR DRIVE UNIT	6201275	2	1003315	4014486477535
5	SHAKER SHAFT DRIVE	6201326	4	1003317	4014486472226
6	STRAW STACKER DRIVE	6201270	1	1003330	4014486478136
7	CLEANING FAN DRIVE	6201273	1	1001003	4014486497267
8	CLEANING SHAFT DRIVE	6201269	2	1003313	4014486476323
9	CLEANING FAN - COUNTERSHAFT	6201297	2	1002229	4014486477917
10	CUTTING UNIT KNIFE	6201253	1	1002220	4014486477764
11	REEL DRIVE VARIABLE SPEED	6201273	1	1001003	4014486497267
12	COUNTER DRIVE (REAR)	6201260	2	1002252	4014486478198

ROSTSELMASH DON 1500 A

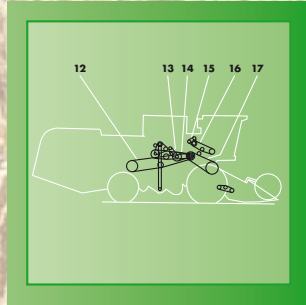
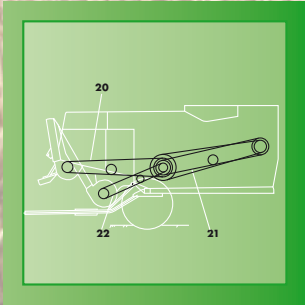

13	COUNTER DRIVE GRAIN	6201197	2	1002236	4014486478006
14	UNLOADING COUNTERDRIVE	6201254	1	1001060	4014486496253
15	AIR CONDITIONING COMPRESSOR DRIVE	6201327	1	1002538	4014486494631
16	HYDRAULIC PUMP - OIL RADIATOR FAN DRIVE	6201264	1	1001962	4014486490701
17	TILTED PLATFORM CHAMBER SHAFT	6201251	1	1003329	4014486491197
18	FAN DRIVE	6201275	2	1003315	4014486477535
19	FAN DRIVE COUNTERSHAFT	6201266	1	1002721	4014486476927
20	CUTTING DRUM	6201328	1	1002248	4014486478150
21	CUTTING DRUM COUNTERDRIVE	6201260	2	1002252	4014486478198
22	AUGER DRIVE	6201325	1	1003322	4014486471502

ROSTSELMASH DON 1500 B

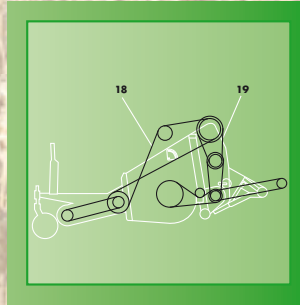
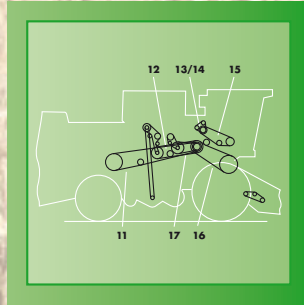
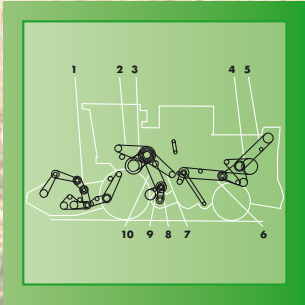

No.	Application	OEM - PN	Set	Optibelt AP-Nr.	EAN
1	REEL DRIVE VARIABLE SPEED	6201273	1	1001003	4014486497267
2	THRESHING DRUM VARIATOR DRIVE	6201249	1	1001306	4014486492644
3	DRUM DRIVE VARIABLE SPEED	6201246	1	1001291	4014486497885
4	SHAKER SHAFT DRIVE	6201326	4	1003317	4014486472226
5	STRAW STACKER DRIVE	6201197	2	1002236	4014486478006
6	ELEVATOR DRIVE UNIT	6201275	2	1003315	4014486477535
7	FINAL THRESHING UNIT	6201272	1	1002186	4014486477306
8	CLEANING FAN DRIVE	6201273	1	1001003	4014486497267
9	CLEANING SHAFT DRIVE	6201269	2	1003313	4014486476323
10	CLEANING FAN - COUNTERSHAFT	6201297	2	1002229	4014486477917
11	COUNTER DRIVE (REAR)	6201260	2	1002252	4014486478198
12	COUNTER DRIVE GRAIN	6201297	2	1002229	4014486477917
13	AIR CONDITIONING COMPRESSOR DRIVE	6201327	1	1002538	4014486494631
14	AIR CONDITIONING COMPRESSOR DRIVE	6201327	1	1002538	4014486494631

ROSTSELMASH DON 1500 B

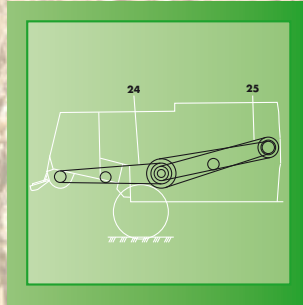
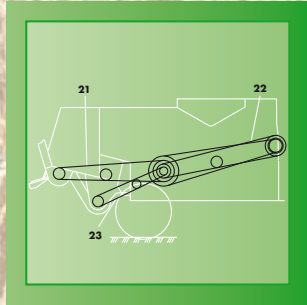
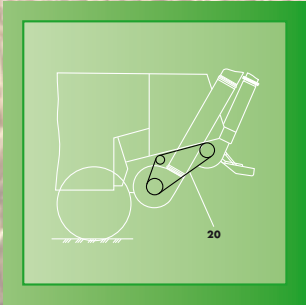

15	HYDRAULIC PUMP - OIL RADIATOR FAN DRIVE	6201264	1	1001962	4014486490701
16	TILTED PLATFORM CHAMBER SHAFT	6201251	1	1003329	4014486491197
17	UNLOADING COUNTERDRIVE	6201254	1	1001060	4014486496253
18	PICK UP DRIVE	6201347	1	1000722	4014486471144
19	PICK UP VARIATOR	6201273	1	1001003	4014486497267
20	FAN ROTOR DRIVE	6201272	1	1002186	4014486477306
21	CUTTING DRUM	6201328	1	1002248	4014486478150
22	CUTTING DRUM COUNTERDRIVE	6201260	2	1002252	4014486478198
23	AUGER DRIVE	6201325	1	1003322	4014486471502
24	CUTTING DRUM	6201328	1	1002248	4014486478150
25	CUTTING DRUM COUNTERDRIVE	6201260	2	1002252	4014486478198

ROSTSELMASH DON 1500 M



No.	Application	OEM - PN	Set	Optibelt AP-Nr.	EAN
1		6201246	1	1001291	4014486497885
2		6201251	1	1003329	4014486491197
3		6201269	2	1003313	4014486476323
4		6201273	1	1001003	4014486497267
5		6201275	2	1003315	4014486477535
6		6201297	2	1002229	4014486477917
7		6201326	4	1003317	4014486472226
8		6201371	1	1002529	4014486494488
9		6201094	1	1002007	4014486491357
10		6201375	1	1001700	4014486486766
11		6201376	2	1002155	4014486476743
12		6201275	2	1003315	4014486477535
13		6201263	2	1002213	4014486477641
14		6201316	1	1001609	4014486485363
15		6201316	1	1001609	4014486485363
16		6201316	1	1001609	4014486485363
17		6201377	1	1001305	4014486492637
18		6201249	1	1001306	4014486492644
19		6201378	1	1001673	4014486486377

ROSTSELMASH DON 680

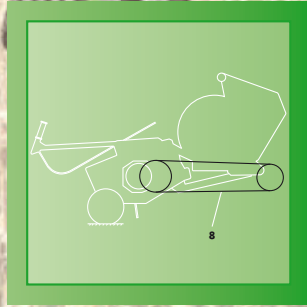
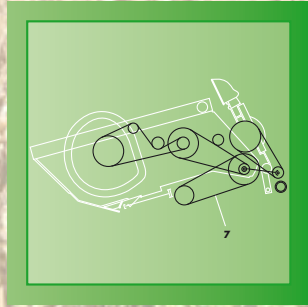
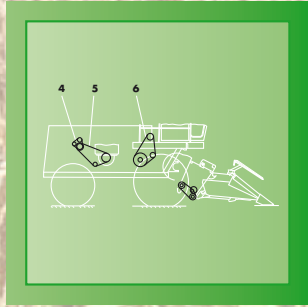
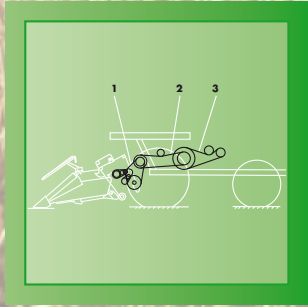

No.	Application	OEM - PN	Set	Optibelt AP-Nr.	EAN
1		6201249	1	1001306	4014486492644
2		6201269	2	1003313	4014486476323
3		6201166	1	1001193	4014486497328
4		6201264	1	1001962	4014486490701
5		6201264	1	1001962	4014486490701
6		6201247	1	1001327	4014486492910
7		6201269	2	1003313	4014486476323
8		6201316	1	1001609	4014486485363

ROSTSELMASH NIVA CK-5M-1-75(79)/77(81)

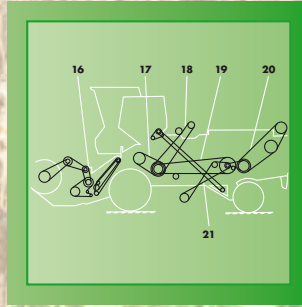
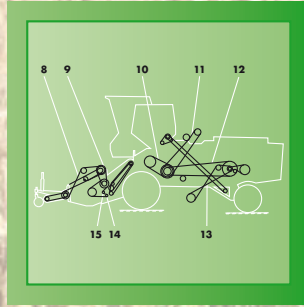
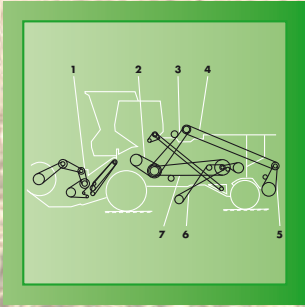

No.	Application	OEM - PN	Set	Optibelt AP-Nr.	EAN
1	REEL DRIVE VARIABLE SPEED	6201351	1	1001081	4014486496628
2	THRESHING DRUM VARIATOR DRIVE	6201258	2	1001203	4014486497601
3	MAIN COUNTERSHAFT DRIVE	6201256	1	1000773	4014486471823
4	CUTTING DRUM	6201348	1	1002730	4014486472950
5	AUGER DRIVE	6201355	3	1000303	4014486465068
6	AUGER (GRAIN)	6201347	1	1000722	4014486471144
7	COUNTER DRIVE MAIN (REAR)	6201354	1	1000972	4014486474329
9	REEL DRIVE VARIABLE SPEED	6201351	1	1001081	4014486496628
10	THRESHING DRUM VARIATOR DRIVE	6201258	2	1001203	4014486497601
11	MAIN COUNTERSHAFT DRIVE	6201256	1	1000773	4014486471823
12	COUNTER DRIVE MAIN (REAR)	6201354	1	1000972	4014486474329
13	AUGER (GRAIN)	6201347	1	1000722	4014486471144
14	AUGER (GRAIN)	6201347	1	1000722	4014486471144
15	COUNTER DRIVE MAIN (REAR)	6201354	1	1000972	4014486474329
16	REEL DRIVE VARIABLE SPEED	6201351	1	1001081	4014486496628
17	THRESHING DRUM VARIATOR DRIVE	6201258	2	1001203	4014486497601
18	MAIN COUNTERSHAFT DRIVE	6201256	1	1000773	4014486471823
19	STACKER DRIVE	6201353	1	1000970	4014486474299
20	AUGER (GRAIN)	6201347	1	1000722	4014486471144
21	SHAKER SHAFT DRIVE	6201346	1	1000636	4014486469929
22	BEATER DRIVE	6201345	1	1000608	4014486469462
23	TILTED PLATFORM CHAMBER SHAFT (UPPER)	6201290	1	1002702	4014486474121

ROSTSELMASH NIVA CK-5M-1-75(79)/77(81)

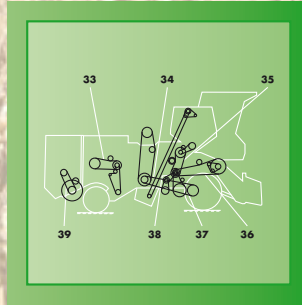
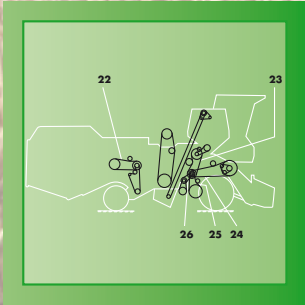

24	CLEANING SHAFT DRIVE	6201343	1	1000579	4014486468960
25	CLEANING FAN DRIVE	6201352	1	1002315	4014486480030
26	SHAKER SHAFT DRIVE	6201346	1	1000636	4014486469929
27	MECHANICAL DRIVE VARIATOR	6201255	1	1002723	4014486497656
28	BEATER DRIVE	6201345	1	1000608	4014486469462
29	TILTED PLATFORM CHAMBER SHAFT (UPPER)	6201290	1	1002702	4014486474121
30	CLEANING SHAFT DRIVE	6201343	1	1000579	4014486468960
31	CLEANING FAN DRIVE	6201352	1	1002315	4014486480030
32	SHAKER SHAFT DRIVE	6201346	1	1000636	4014486469929
33	MECHANICAL DRIVE VARIATOR	6201255	1	1002723	4014486497656
34	BEATER DRIVE	6201345	1	1000608	4014486469462
35	TILTED PLATFORM CHAMBER SHAFT (UPPER)	6201290	1	1002702	4014486474121
36	CLEANING SHAFT DRIVE	6201343	1	1000579	4014486468960
37	CLEANING FAN DRIVE	6201352	1	1002315	4014486480030
38	SHREDDER FAN DRIVE	6201344	1	1003324	4014486469288

ROSTSELMASH VECTOR

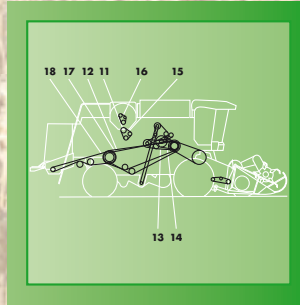
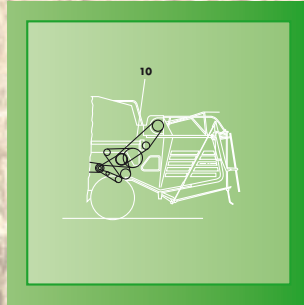
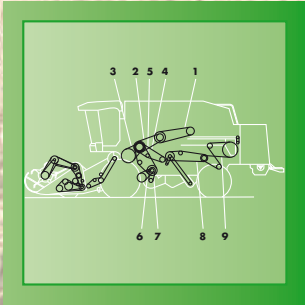

No.	Application	OEM - PN	Set	Optibelt AP-Nr.	EAN
1	MAIN COUNTERSHAFT DRIVE	6201016	1	1001986	4014486491067
2	BEATER DRIVE	6201015	1	1001259	4014486492187
3	DRUM DRIVE VARIABLE SPEED	6201246	1	1001291	4014486497885
4	FINAL THRESHING UNIT	6201272	1	1002186	4014486477306
5	CLEANING FAN - COUNTERSHAFT	6201297	2	1002229	4014486477917
6	CLEANING SHAFT DRIVE	6201269	2	1003313	4014486476323
7	CLEANING FAN DRIVE	6201273	1	1001003	4014486497267
8	ELEVATOR DRIVE UNIT	6201275	2	1003315	4014486477535
9	SHAKER SHAFT DRIVE	6201326	4	1003317	4014486472226
10	STRAW STACKER DRIVE	6201197	2	1002236	4014486478006
11	TILTED PLATFORM CHAMBER SHAFT	6201251	1	1003329	4014486491197
12	COUNTER DRIVE (REAR)	6201260	2	1002252	4014486478198

ROSTSELMASH VECTOR

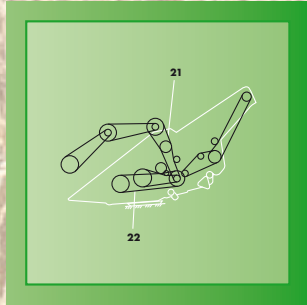
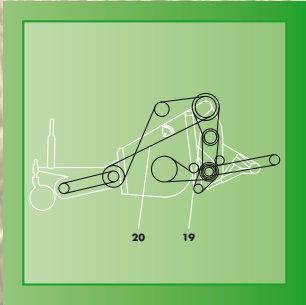

13	COUNTER DRIVE GRAIN	6201271	2	1002226	4014486477849
14	UNLOADING COUNTERDRIVE	6201254	1	1001060	4014486496253
15	DUST REMOVING FAN	6201028	1	1000217	4014486462760
16	AIR CONDITIONING COMPRESSOR DRIVE	6201327	1	1002538	4014486494631
17	CUTTING DRUM COUNTERDRIVE	6201260	2	1002252	4014486478198
18	CUTTING DRUM	6201017	1	1000835	4014486472622
19	SHAFT VARIATOR (UPPER)	6201273	1	1001003	4014486497267
20	PICK UP MAIN SHAFT	6201347	1	1000722	4014486471144
21	REEL DRIVE VARIABLE SPEED	6201273	1	1001003	4014486497267
22	CUTTING UNIT KNIFE	6201253	1	1002220	4014486477764

NOTES



NOTES



NOTES



Owner of any and all copyrights and intellectual property rights as well as other rights of use and exploitation: Arntz Optibelt Group, Höxter/Germany. Any use, exploitation, reproduction, and any transfer to third parties by any means shall require the prior written approval of the Arntz Optibelt Group, Höxter/Germany.

© Arntz Optibelt Group 612408/0612Hux

600 © Arntz Optibelt Group, Germany

www.optibelt.com

Lieferprogramm

Product Range



Made by Optibelt



1 **optibelt KR**

AGRO POWER Keilriemen
V-Belt

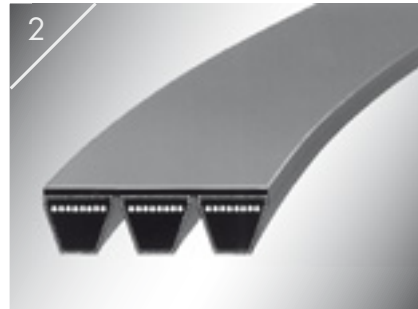
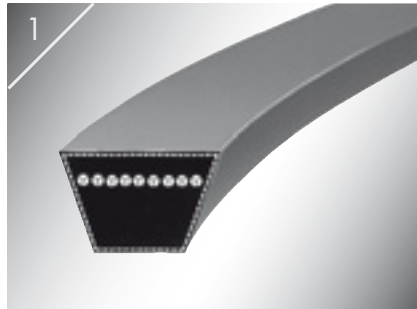

2 **optibelt KB**

AGRO POWER Kraftband
Kraftband

3 **optibelt RB**

AGRO POWER Rippenband
Ribbed Belt

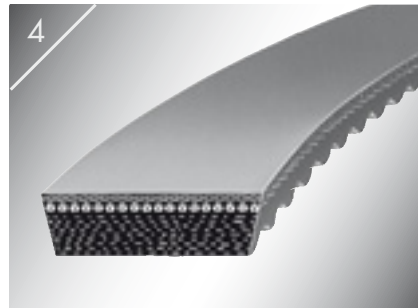
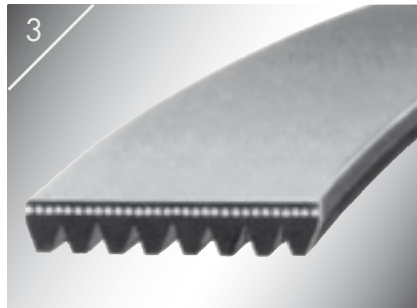

4 **optibelt SVX**

AGRO POWER Breitkeilriemen
Variable Speed Belt